



**Built-in Household Appliances**  
2016-2017

**VESTEL**





**Company Profile**  
02-03



**Global Operations**  
04-05



**Refrigerators**  
06-16



**60cm Dishwashers**  
17-47



**45 cm Dishwashers**  
48-59



**Ovens**  
60-105



**Hobs**  
106-169



**Specifications**  
170-203



**Addresses**  
207





## Company Profile

Vestel City, which comprises nine plants located in Manisa, is amongst the biggest industrial complexes of the world.

As one of the leading enterprises in Turkey, Vestel is a major player in consumer electronics, mobile technologies, household appliances, professional displays and LED lighting with renowned products, including refrigerators, washing machines, cooking appliances, dishwashers, air conditioners, water heaters, television sets, educational, hospitality and digital signage solutions, digital set-top boxes, tablet PCs, and smart phones.

The company is recognised for its cutting-edge designs, high product quality, large production capacity, and superior market share growth.

Vestel is one of the ten biggest household appliance manufacturers in Europe, with its new product development ability, flexibility in production, and fast response to clients' demands.



Operating with an annual capacity of 3.2 million units, the company's two refrigerator plants produce a variety of models ranging from french door, no-frost, combi, double door, single door, to table top fridges and freezers, as well as built-in models.

Achieving similar success with washing machines, Vestel is able to produce 2.5 million units a year, with models ranging from 4 kg to 9 kg drum capacities. The group added washer



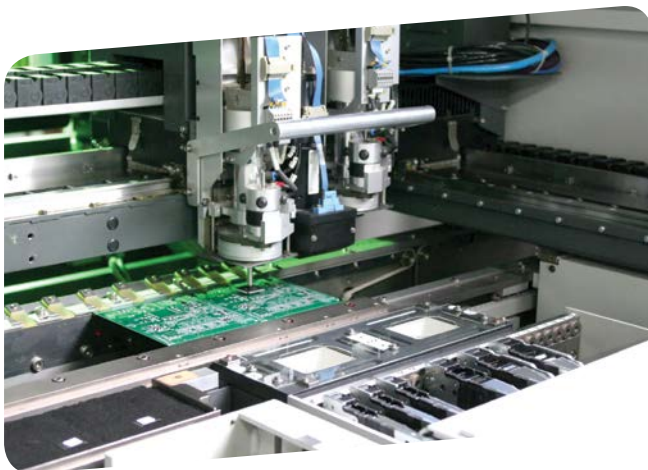
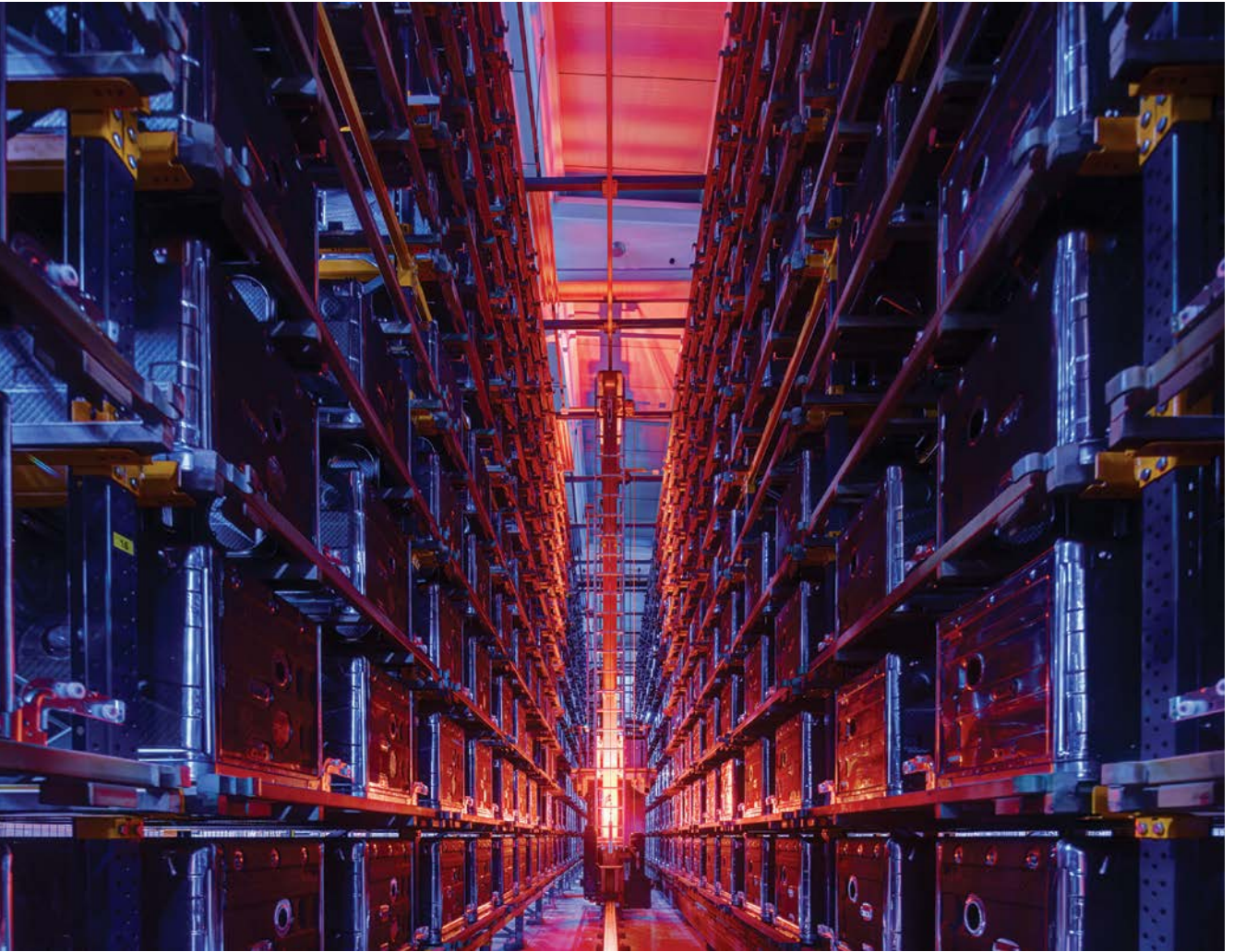

dryers to the product range in 2012. The plant for cooking appliances operates with an annual capacity of 2.2 million units, producing free-standing cookers, built-in hobs and ovens.

The household appliances product range includes free standing, semi and fully integrated dishwashers. The plant has the capacity to produce 2.5 million units a year.

In addition, the air conditioner factory is capable of producing 750,000 units of split-type models.

Vestel is the first company in Turkey operating two manufacturing plants in Russia for the production of refrigerators, washing machines, and televisions with the aim of becoming a leader in CIS countries.

Vestel Trade, the company responsible for the marketing and sales of Vestel products overseas, exports 73% percent of its production under leading Japanese and European brands to 152 countries.

Vestel Trade has achieved export sales of 8.3 million units of electronics and 4.8 million units of household appliances.

Distributing its products to seven continents, Vestel takes its place as a world-class company.

 Global Operations



## Manufacturing & Assembly Plants

Refrigerator, Washing Machine, Dishwasher, Cooking Appliances, Air Conditioner, Water Heater Manisa, Turkey

LED TV, HD, IP/OTT, PVR Set-top Boxes – Manisa, Turkey

Professional Displays, Tablet PC, Smart Phone, LED lighting – Manisa Turkey

## Marketing & Sales Companies

Vestel Trade, Turkey

Vestel France, France

Vestel Germany, Germany

Vestel UK, The UK

Vestel Iberia, Spain

Gruppo Industriale Vesit, Italy

Vestel Benelux, The Netherlands

Vestel CIS Ltd, Russia

Vestel Electronica, Romania

Vestel Scandinavia, Finland

Vestfrost Household, Denmark

Vestel Central Asia, Kazakhstan

## R&D Centers

Manisa, Turkey

Istanbul, Turkey

Bristol, UK

Shanghai, China



# Refrigerators





**DOOR ON DOOR MODELS**

Cabinet door is mounted directly onto the refrigerator door and with the help of the hinge, the refrigerator opens wider and closes automatically.



**SLIDING DOOR MODELS**

Cabinet door is Connected to the refrigerator door with sliding rails.



**SAFETY GLASS**

Glass shelves are made of safety glass and can hold upto 20 kg in weight.



**REMOVABLE MAGNETIC GASKET**

The gasket prevents growth of bacteria and microorganisms.



**EASY LOCK FREEZER**

Mechanism of the handle enables easy opening and closing of the door.

Red mark on the door indicates and warns the user when the freezer door is left open.



**CONTROL PANEL**

Warning lights advise current freezer status and internal temperature rise.

Quick Service Control Box Thermostat and other controls are easily reachable for service purposes.

**ENERGY EFFICIENCY**

Vestel built-in fridges and freezers are available with or A++, A+ or A energy class.



**REVERSIBLE DOORS**

All Vestel refrigerator doors can be opened to the left or right with a simple adjustment.

Wire shelves and opaque white accessories are also available for all models.

**STAR RATING** 

All Vestel freezers have 4 star rating which allows you to safely freeze fresh food and deeply store frozen food.



## BGN 2795

### BUILT-IN SINGLE DOOR

Niche 1780mm  
Sliding door  
Door on Door  
Reversible doors

### FRIDGE

Turbo fan air cooling  
Air Duct  
Safety Glass Shelves  
1 Glass Shelf over Crisper  
2 Crispers  
Automatic Defrosting  
Humidity Controller

### TECHNICAL DATA

Energy Class: A++/A+  
Gross/Net Volume: 303lt/300lt  
Product Dimensions (HxWxD): 1770x540x545

### INDOOR FEATURES

1 Dairy Rack  
1 Egg Holder  
3 Transparent shelves  
1 Bottle Shelf

### OPTIONAL FEATURES

Electronic Head Panel Display  
LED Lighting  
Wine Shelf  
Adjustable Door Rack  
MaxiFresh Preserver

A<sup>++</sup>

A<sup>+</sup>

## BGN 2791

### BUILT-IN SINGLE DOOR

Niche 1780mm  
Sliding door  
Door on Door  
Reversible doors

### TECHNICAL DATA

Energy Class: A++/A+  
Gross/Net Volume: 221lt/197lt  
Product Dimensions (HxWxD): 1770x540x545

### FREEZER

4 star freezer  
7 Freezer Compartments + 1 Flap  
Automatic Defrosting

### OPTIONAL FEATURES

Sliding Icematic  
LED Lighting



A<sup>++</sup>

A<sup>+</sup>





## BGN 2761

### BUILT-IN COMBI

Niche 1780mm, Sliding door  
Door on Door, Reversible doors

### FREEZER

Automatic Defrosting  
4 star freezer, 1 Ice Box  
3 Freezer Compartments

### TECHNICAL DATA

Energy Class: A++/A+  
Gross/Net Volume: 251lt/237lt  
Net Fridge/Freezer Volume: 179lt/58lt  
Product Dimensions (HxWxD):  
1770x540x545

### INDOOR FEATURES

1 Dairy Rack, 1 Egg Holder  
2 Transparent shelves, 1 Bottle Shelf

### FRIDGE

Safety Glass Shelves  
1 Glass Shelf over Crisper, 1 Crisper  
Automatic Defrosting  
Humidity Controller

### OPTIONAL FEATURES

Electronic Head Panel Display  
Turbo Fan Air Cooling  
Air Duct  
LED Lighting  
Wine Shelf  
Adjustable Door Rack  
MaxiFresh Preserver

A++

A+

## BGN 2760

### BUILT-IN COMBI

Niche 1780mm, Sliding door  
Door on Door, Reversible doors

### FREEZER

4 star freezer, 1 Ice Box  
3 Freezer Compartments

### TECHNICAL DATA

Energy Class: A++/A+  
Gross/Net Volume: 251lt/243lt  
Net Fridge/Freezer Volume: 179lt/64lt  
Product Dimensions (HxWxD):  
1770x540x545

### INDOOR FEATURES

1 Dairy Rack, 1 Egg Holder  
2 Transparent shelves, 1 Bottle Shelf

### FRIDGE

Safety Glass Shelves  
1 Glass Shelf over Crisper, 1 Crisper  
Humidity Controller

### OPTIONAL FEATURES

Wine Shelf  
Adjustable Door Rack  
MaxiFresh Preserver



A++

A+



## BGN 2751

### BUILT-IN COMBI

Niche 1780mm, Sliding door  
Door on Door, Reversible doors

### FREEZER

Automatic Defrosting  
4 star freezer, 1 Ice Box  
4 Freezer Compartments

### TECHNICAL DATA

Energy Class: A++/A+  
Gross/Net Volume: 245lt/227lt  
Net Fridge/Freezer Volume: 146lt/81lt  
Product Dimensions (HxWxD): 1770x540x545

### INDOOR FEATURES

1 Dairy Rack, 1 Egg Holder  
1 Transparent Shelf, 1 Bottle Shelf

### FRIDGE

Safety Glass Shelves  
1 Glass Shelf over Crisper, 1 Crisper  
Automatic Defrosting  
Humidity Controller

### OPTIONAL FEATURES

Electronic Head Panel Display  
Turbo Fan Air Cooling  
LED Lighting  
Wine Shelf  
Adjustable Door Rack  
MaxiFresh Preserver



## BGN 2750

### BUILT-IN COMBI

Niche 1780mm, Sliding door  
Door on Door, Reversible doors

### FREEZER

4 star freezer, 1 Ice Box  
4 Freezer Compartments

### TECHNICAL DATA

Energy Class: A+  
Gross/Net Volume: 245lt/235lt  
Net Fridge/Freezer Volume: 146lt/89lt  
Product Dimensions (HxWxD): 1770x540x545

### INDOOR FEATURES

1 Dairy Rack, 1 Egg Holder  
1 Transparent Shelf, 1 Bottle Shelf

### FRIDGE

Safety Glass Shelves  
1 Glass Shelf over Crisper, 1 Crisper  
Humidity Controller

### OPTIONAL FEATURES

Wine Shelf  
Adjustable Door Rack  
MaxiFresh Preserver



A<sup>+</sup>

A

## BGN 3200

### BUILT-IN FROST FREE COMBI

Niche 1780 mm  
Sliding Door  
Door on Door also available BGN3200 D

### FRIDGE

3 Removable Shelves  
Spill Proof Safety Glass Shelves 1 Glass Shelf over Crisper  
2 Crispers

### TECHNICAL DATA

Energy Class: A+ / A  
Gross / Net Volume: 276 lt / 264 lt  
Net Fridge / Freezer Volume: 189 lt / 75 lt  
Product Dimensions (HxWxD):  
1770 x 540 x 545 mm

### INDOOR FEATURES

1 Dairy Rack with Transparent Cover  
1 Egg Holder  
2 Transparent Shelves  
1 Bottle Shelves

### FREEZER

\*\*\*\* Freezer  
3 Freezer Compartment  
1 Ice Box  
Manual Defrost

## BGN 2610

### BUILT-IN DOUBLE DOOR

Niche 1450 mm  
Sliding Door  
Door on Door : BGN2610  
DOD Reversible Doors

### FRIDGE

3 Removable Shelves  
Safety Glass Shelves  
1 Glass Shelf over Crisper  
2 Crispers

### TECHNICAL DATA

Energy Class: A++ / A+  
Gross / Net Volume: 217 lt / 214 lt  
Net Fridge / Freezer Volume: 176 lt / 38 lt  
Product Dimensions (HxWxD):  
1445 x 540 x 545 mm

### INDOOR FEATURES

1 Dairy Rack  
1 Egg Holder  
2 Transparent Shelves  
1 Bottle Shelf

### FREEZER

\*\*\*\* Freezer  
3 Freezer compartments  
1 Ice Box

A<sup>++</sup>A<sup>+</sup>



## BGN 2400



### BUILT-IN SINGLE DOOR

Niche 1230 mm  
Sliding Door  
Door on Door: BGN2400  
DOD Reversible Door

### FRIDGE

\*\*\* Freezer Compartment  
Freezer Door Indicator  
1 Ice Box  
3 Removable Shelves  
Safety Glass Shelves  
1 Glass Shelf over Crisper  
2 Crispers

### TECHINCAL DATA

Energy Class: A++ / A+ / A  
Gross / Net Volume: 195 lt / 192 lt  
Net Fridge / Freezer Volume: 175 lt/17 lt  
Product Dimensions (HxWxD):  
1225x540x545 mm

### INDOOR FEATURES

1 Dairy Rack  
1 Egg Holder  
2 Transparent Shelves  
1 Bottle Shelf

A++

A+

## BGN 2500

### BUILT-IN SINGLE DOOR

Niche 1230 mm  
Sliding Door  
Door on Door: BGN2500  
DOD Reversible Door

### FRIDGE

4 Removable Shelves  
Safety Glass Shelves  
1 Glass Shelf over Crisper  
2 Crispers

### TECHNICAL DATA

Energy Class: A++ / A+ / A  
Gross / Net Volume: 206 lt / 204 lt  
Product Dimensions (HxWxD):  
1225 x 540 x 545 mm

### INDOOR FEATURES

1 Dairy Rack  
1 Egg Holder  
2 Transparent Shelves  
1 Bottle Shelf



A++

A+

## BGN 1800



### BUILT-IN SINGLE DOOR

Niche 1030 mm  
Sliding Door  
Door on Door: BGN1800  
DOD Reversible Door

### FRIDGE

\*\*\*\* Freezer Compartment  
Freezer Door Indicator  
1 Ice Box  
2 Removable Shelves  
Safety Glass Shelves  
1 Glass Shelf over Crisper  
2 Crispers

### TECHINCAL DATA

Energy Class: A++ / A+ / A  
Gross / Net Volume: 153 lt / 150 lt  
Net Fridge / Freezer Volume: 133 lt/17 lt  
Product Dimensions (HxWxD):  
1020 x 540 x 545 mm

### FREEZER

1 Dairy Rack  
1 Egg Holder  
2 Transparent Shelves  
1 Bottle Shelf

A++

A+

## BGN 1900

### BUILT-IN SINGLE DOOR

Niche 1030 mm  
Sliding Door  
Door on Door: BGN1900  
DOD Reversible Door

### FRIDGE

3 Removable Shelves  
Safety Glass Shelves  
1 Glass Shelf over Crisper  
2 Crispers

### TECHNICAL DATA

Energy Class: A++ / A+ / A  
Gross / Net Volume: 162 lt / 160 lt  
Product Dimensions (HxWxD):  
1020 x 540 x 545 mm

### INDOOR FEATURES

1 Dairy Rack  
1 Egg Holder  
2 Transparent Shelves  
1 Bottle Shelf



A++

A+



## BGN 1400

### BUILT-IN SINGLE DOOR

Niche 880 mm  
Sliding Door  
Door on Door: BGN1400  
DOD Reversible Door

### FRIDGE

\*\*\*\* Freezer Compartment  
Freezer Door Indicator  
1 Ice Box  
2 Removable Shelves  
Safety Glass Shelves  
1 Glass Shelf over Crisper  
2 Crispers

### TECHINCAL DATA

Energy Class: A++ / A+ / A Gross / Net  
Volume: 126 lt / 123 lt Net Fridge /  
Freezer Volume:  
106 lt / 17 lt  
Product Dimensions (HxWxD):  
875 x 540 x 545 mm

### INDOOR FEATURES

1 Dairy Rack  
1 Egg Holder  
1 Transparent Shelf  
1 Bottle Shelf

A++

A+

## BGN 1500

### BUILT-IN SINGLE DOOR

Niche 880 mm  
Sliding Door  
Door on Door: BGN1500  
DOD Reversible Door

### FRIDGE

3 Removable Shelves  
Safety Glass Shelves  
1 Glass Shelf over Crisper  
2 Crispers

### TECHINCAL DATA

Energy Class: A++ / A+ / A  
Gross / Net Volume: 137 lt / 136 lt  
Product Dimensions (HxWxD):  
875 x 540 x 545 mm

### INDOOR FEATURES

1 Dairy Rack  
1 Egg Holder  
1 Transparent Shelves  
1 Bottle Shelf



A++

A+



## BGN 1450

### BUILT-IN SINGLE DOOR

Niche 880 mm  
Sliding Door  
Door on Door: BGN1450  
DOD Reversible Door

### FRIDGE

\*\*\*\* Freezer  
4 Freezer Compartments  
1 Ice Box  
Manual Defrost  
Control Panel

### TECHINCAL DATA

Energy Class: A++ / A+ / A Gross / Net  
Volume: 109 lt / 99 lt  
Product Dimensions (HxWxD):  
875 x 540 x 545 mm  
Quick Freeze  
Mains On  
Temperature Rise Warning

A++

A+



## BGN 1600 DOD

### BUILT-IN SINGLE DOOR

Niche 820 mm  
Door On Door  
Reversible Door

### FRIDGE

1 Removable Shelf  
1 Glass Shelf over Crisper  
1 Crisper  
Safety Glass Shelves

### TECHINCAL DATA

Energy Class: A+  
Gross / Net Volume: 120 lt / 115 lt  
Product Dimensions (HxWxD):  
818 x 595 x 548 mm

### INDOOR FEATURES

1 Transparent Shelf  
1 Egg Holder  
1 Bottle Shelf

A<sup>+</sup>

## BGN 1700 DOD

### BUILT-IN SINGLE DOOR

Niche 820 mm  
Door On Door  
Reversible Door

### FRIDGE

2 Removable Shelves  
1 Glass Shelf over Crisper  
1 Crisper  
Spill Proof Safety Glass Shelves

### TECHINCAL DATA

Energy Class: A+ / A  
Gross / Net Volume: 136 lt / 133 lt  
Product Dimensions (HxWxD):  
818 x 595 x 548 mm

### INDOOR FEATURES

1 Transparent Shelf  
1 Egg Holder  
1 Bottle Shelf



A<sup>++</sup>

A<sup>+</sup>



## BGN 1650 DOD

### BUILT-IN SINGLE DOOR

Niche 820 mm  
Door On Door  
Reversible Door

### TECHINCAL DATA

Energy Class: A+ / A  
Gross / Net Volume: 107 lt / 95 lt  
Product Dimensions (HxWxD):  
818 x 595 x 548 mm

### FRIDGE

\*\*\*\* Freezer  
3 Freezer Compartments  
1 Ice Box  
Manual Defrost  
Control Panel  
Quick Freeze  
Mains On  
Temperature Rise Warning

A<sup>+</sup>

A



# INSTALLATIONS

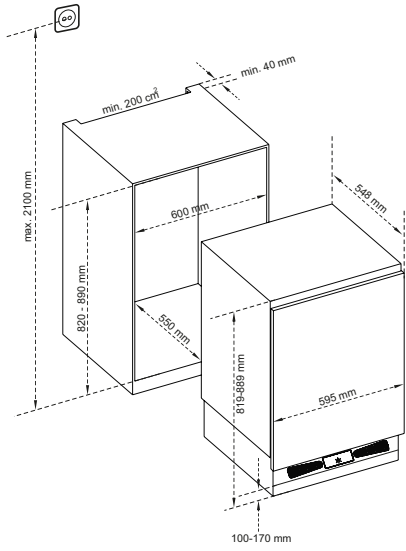

1600 / 1650 / 1700

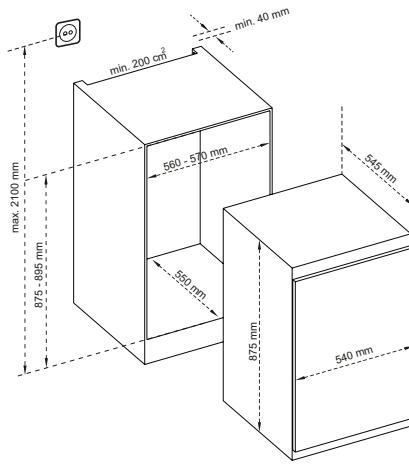

1400 / 1450 / 1500

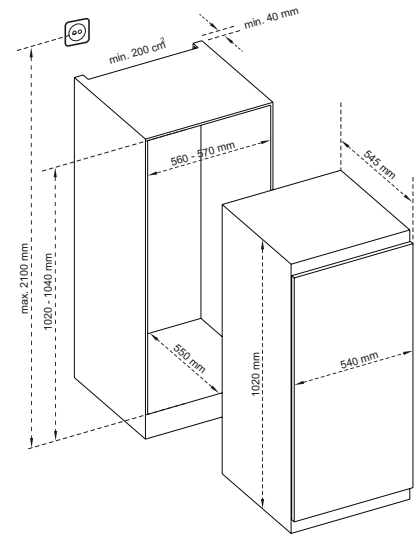

1800 / 1900

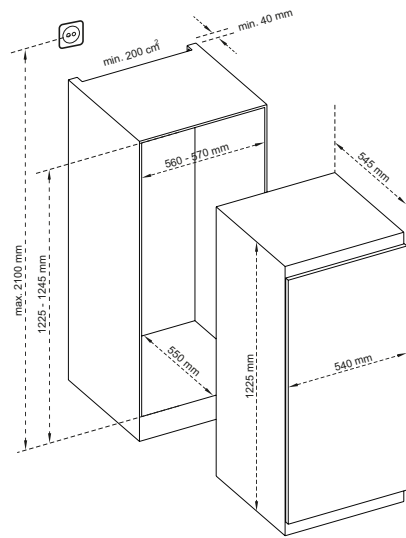

2400 / 2500

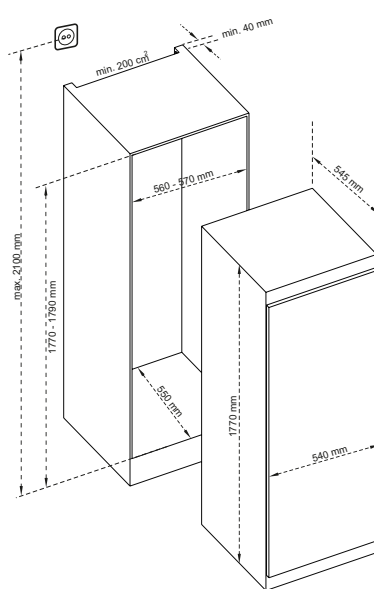

2791 / 2795

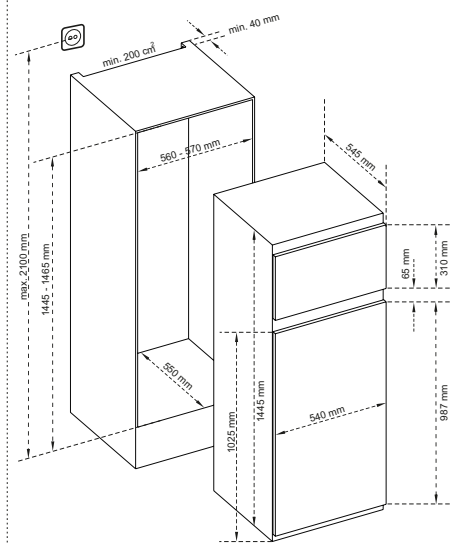

2610

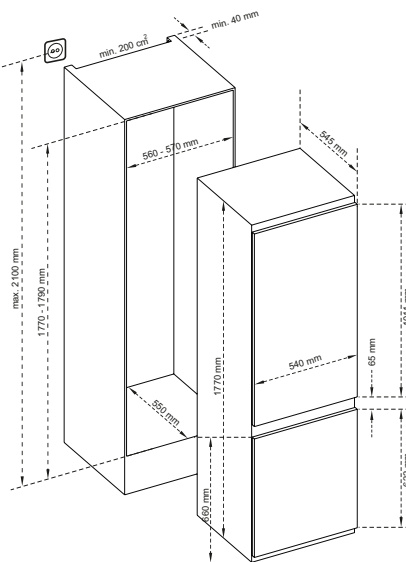

3200

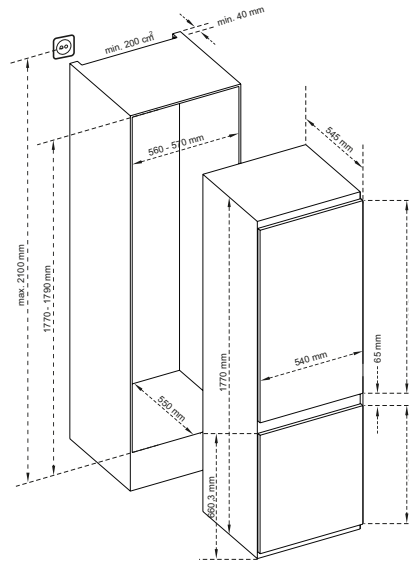

2760 / 2761

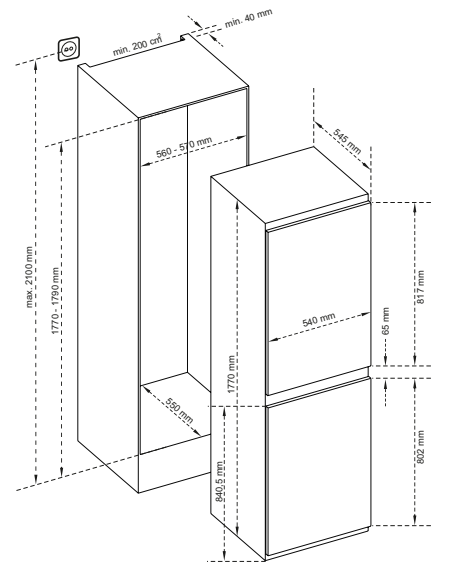

2750 / 2751

# 60 cm Dishwashers





**A+++ -20% A++/A+++AA/A+++AA Class**

“Top class ratings for “energy consumption”, “cleaning & drying performance”. The minimum energy class is A++ and the cleaning & drying performance is A for entire model range.



**EXTRA DRYING**

It is possible to have better drying performance with extra drying option. This option increases water temperature at final rinse step and drying step duration up to 10 min.



**EXTRA SILENT**

It is possible to have more silent washing with variable speed motor technology! Extra silent option decreases noise level of program without decreasing cleaning quality in day or night time when silence is required.



**AUTO PROGRAMS WITH TURBIDITY SENSOR**

Turbidity sensor detects the amount of turbidity in water and adjusts the washing cycle parameters (temperature, duration, amount of water) accordingly.



**EXTRA FAST**

Extra fast option decreases program duration while it is increasing water temperature and pressure to ensure high washing quality in a shorter duration.



**EXTRA HYGIENE**

Extra hygiene option which is developed for Vestel Dishwashers ensures a maximum hygiene with high temperature washing. It increases water temperature at final rinse step in order to eliminate bacteria up to %99.9999.





#### EXTRA RINSE

Extra rinse option adds an extra rinse step to achieve more hygienic washing. Program duration is increased between min. %4 and max. %16 according to the washing program.



#### ANTIBACTERIAL FILTER

By using Antibacterial PP Sump Filter bacterial growth on the filter surface eliminated up to 99%.



#### SUPER 50'

VESTEL dishwashers achieves A class cleaning performance with advanced cleaning program in only 50 min without diverter. You can save time with this program. It is the first and unique dishwasher that achieves A class cleaning performance in only 50 minutes for standart soiled dishes according to EN standards.



#### BLDC PUMP TECHNOLOGY

This technology enables all other options and program to save water, energy and time. Also by changing water pressure noise level can be reduced to have more silent washing.



#### DELAY TIMER

The start time of a program can be delayed, e.g. to benefit from economy rates of electricity. A delay start time of between 1 hour and 24 hours can be selected.



#### TABLET/ALL IN 1 OPTION

Tablet detergents and combined detergent that contains salt, rinse aid and extra functions are compact and easy to use. But they may have some drawbacks or undissolved tablet residues which are left in the machine. With this option, water reaches optimum temperature to dissolve the combined detergent ideally and eliminates such drawbacks and assures maximum performance when tablet detergents are used.



**HALF LOAD- 1/2 OPTION**

Eco Friendly Ecowash technology provides washing performance when dishwasher is not fully loaded, only lower basket or upper basket or both are used with half load if necessary by using half load option. Ecowash technology saves energy and water by reducing energy and water consumption due to load options.



**VARIOSPACE**

VarioSpace is a general feature that gives many options to the end user regarding lower and upper basket variations.



**JET WASH**

With this fast program, you can clean the dishes like less and/or recently soiled (coffee, milk and tea etc.) in only 18 minutes. This program is one of the fastest programs in the world. It cleans your dishes with 4 place settings capacity in 18 minutes. With this option, water reaches optimum temperature to dissolve the combined detergent ideally and eliminates such drawbacks and assures maximum performance.



**DUALPRO WASH**

Advanced pump technology allows for one wash to be cleaned at two separate water pressures. Baked on food doesn't stand a chance in the bottom while the delicate glasses in the top are gently being washed.



**EASY TRAY**

The upper cutlery basket is designed to place forks, spoons and knives, long dippers and small items. It is possible to take out the dishes along with the 3rd rack after washing. The Upper Cutlery Basket is composed of two pieces; You can take out left or right part of the upper cutlery basket to obtain more space for the dishes in the upper basket



**CHILD LOCK**

Child lock option never allows your children to play with your dishwasher. It allows you to lock the buttons on the control panel to be able to restrict the functionality of buttons.

**OVERFLOW AND LEAKAGE PROTECTION**

The dishwasher activates overflow mode when there is too much water in the dishwasher and the excess water gets drained. It also detects leaks in the base of the dishwasher, shuts down operation and automatically pumps out water before reaching to floor. The unit can auto reset the overflow mode until the water level in the basement cover reaches a certain level.

**HEATER SAFETY PROTECTION**

In case of lack of water, with the help of a pressure switch, the resistance is prevented from being in operation. So both the resistance and the machine itself are protected.

**TURBO DRYING SYSTEM**

It activates a fan which draws steam out of the dishwasher cabinet. Air circulation is much more forced, hence results in most efficient drying performance.

**MINI ACTIVE DRYING SYSTEM**

Mini active drying system provides basic drying performance on dishes with its mini fins.

**SUPER ACTIVE DRYING SYSTEM**

A portion of the washtub wall is a heat exchanger which, at the end of the rinsing cycle, promotes condensation of the water inside the tub, and hence drying of the dishes.





**AUTO DOOR**

Auto Door is a technology that makes the drying process more efficient. Auto Door opens the door of the dishwasher during the drying process automatically and by this way the hot air goes out of the dishwasher by itself and so the energy needed to dry the dishes is reduced significantly.

A+++ -20% energy consumption for 14 P.S. is achieved with the help of this technology.



**WATER BOX**

The working principle of Water Box Technology is based on getting the last clean cycle rinse water, filtering it to avoid any particles and saving it in an isolated box. Then it can be used as the prewash cycle cleaning water next for the cycle. 5,4 lt water consumption with A++ energy rating for 15 P.S. is achieved with the help of this technology.

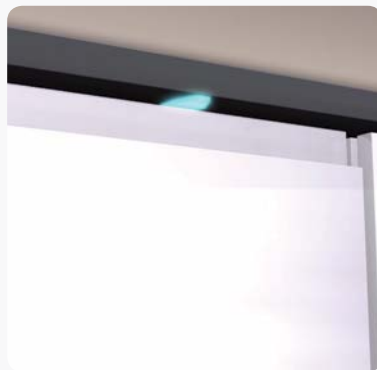

**INFO LED**

Infoled provides information to the user about the current status of dishwasher during washing.

If the light is on, It notifies that dishwasher continues to operate or the notification light turns off when program finishes.

**ION TECH**

Natural Ion Tech spreads negative ions inside the dishwasher. These negative ions neutralize particles of unpleasant smell. Natural Ion Tech removes odors caused by dirty dishes.

**DIRECT WASH**

Direct wash spray system is used for washing baby bottles and glasses more effective.

**TRIPLE WASH**

Triple wash feature offers wide washing option to user. User can wash hard soiled pans and cookers more effective with triple wash sprays.

**STEAM WASH**

Steam Wash technology softens the most stubborn dirt by steam power. High temperature and directly applied steam ensure perfect hygiene and gentle cleaning for your sensitive dishes.

Upper Basket

MESH TYPE



PEG TYPE



UPPER BASKET OPTIONS

FOLDABLE WIRE



ADJUSTABLE MUG SHELVES



SPOON RACK & GLASS SUPPORT



ADJUSTABLE UPPER BASKET WITH LOAD



ADJUSTABLE UPPER BASKET WITHOUT LOAD



PLASTIC HANDLE



WIRE HANDLE

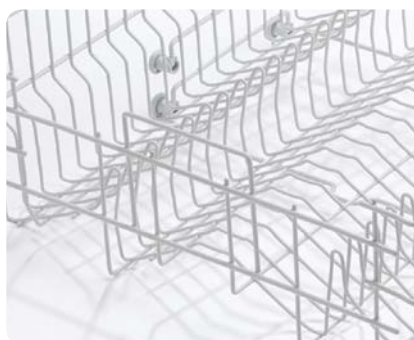

HANDLE WITH CUSTOMIZED LOGO



\* For 15 place settings and only for upper basket



**Lower Basket**

12 PLACE SETTINGS



15 PLACE SETTINGS



12 PLACE SETTINGS (FOR SLIDING CUTLERY BASKET)



\* 13 PS will be available on May 2017 as option.



**LOWER BASKET OPTIONS**

FOLDABLE WIRE (2 OR 4)



MULTI-FUNCTIONAL KIT FOR LOWER BASKET



BOTTLE HOLDER



PLASTIC HANDLE



WIRE HANDLE



UNIVERSAL CUTLERY BASKET



STANDARD CUTLERY BASKET



MODULAR CUTLERY BASKET



SLIDING CUTLERY BASKET



WINE GLASS HOLDER

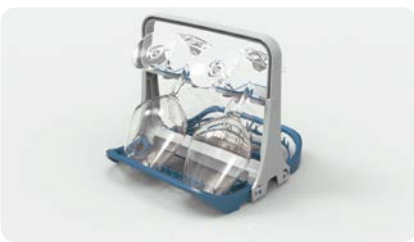

MUG SHELF SUPPORT



## 3<sup>rd</sup> Rack

### UPPER CUTLERY BASKET

The upper cutlery basket is designed to place forks, spoons and knives, long dippers and small items. You can take out the dishes along with the 3<sup>rd</sup> rack washing.



VarioSpace  
EasyTray

The Upper Cutlery Basket is composed of two pieces; you can take out the left or right part of the upper cutlery basket to obtain more space for the dishes





**Extras**

**TOP NOZZLE**  
(OPTIONAL FOR 12 P.S.)



**IMPELLER**  
(OPTIONAL FOR 15 P.S.)



**AQUA STOP**



**PLASTIC FILTER**  
(OPTIONAL)



**STAINLESS STEEL FILTER (DEFAULT)**



**ANTIBACTERIAL FILTER (OPTIONAL)**



**INTERIOR LED LIGHTING (WHITE)**



**Pop-in-Pop-out-Knob for Semi Integrated Dishwasher**



FEATURES

ADJUSTABLE REAR FOOT FROM THE FRONT



FRONT DECOR FIXATIONS DIFFERENT WEIGHTS



ADJUSTABLE PLINTH



0-100 mm dept adjustment  
820-870 mm machine height adjustment with high feet

The machine can be elevated by 50 mm (820 → 870-920 mm with high feet)

HIGH FEET



PLATE DIMENSION FOR 12 P.S.



PLATE DIMENSION FOR 15 P.S.



SEMI-INTEGRATED



FULLY-INTEGRATED



## T3X (LED) Series



T31, T32: Big LED display (remaining time, delay timer), 6-8 programs, rinse-aid & salt indicators, child lock option, washing cycle indicators, half load option (with three modes: lower basket / upper basket / half load on both baskets), delay timer (1-2-3-...-24hr), 3in1 tablet detergent option, extra hygiene option, extra dry option

T34: Big LED display (remaining time, delay timer), 8 programs, rinse-aid & salt indicators, child lock option, washing cycle indicators, half load option (with three modes: lower basket / upper basket / half load on both baskets), delay timer (1-2-3-...-24hr), 3in1 tablet detergent option, energy save option, extra silent option, extra fast option

T35: Big LED display (remaining time, delay timer), 8 programs, rinse-aid & salt indicators, child lock option, washing cycle indicators, half load option (with three modes: lower basket / upper basket / half load on both baskets), delay timer (1-2-3-...-24hr), 3in1 tablet detergent option, energy save option, extra silent option, extra fast optionsystem.

## T Series



T11: 3 programs, rinse-aid & salt indicators, child lock option, washing cycle indicators, half load option (with one mode)



T12: 4 programs, rinse-aid & salt indicators, child lock option, washing cycle indicators, half load option (with one mode), display (remaining time, delay timer), delay timer (1-2-3-...-24hr)



T13: 6 programs, rinse-aid & salt indicators, child lock option, washing cycle indicators, half load option (with one mode), display (remaining time, delay timer), delay timer (1-2-3-...-24hr), 3in1 tablet detergent option, extra hygiene option



T21: 8 programs, rinse-aid & salt indicators, child lock option, washing cycle indicators, half load option (with three modes: lower basket / upper basket / half load on both baskets), display (remaining time, delay timer), delay timer (1-2-3-...-24hr), 3in1 tablet detergent option, extra dry option, extra rinse option, extra hygiene option. detergent option

T24: 8 programs, rinse-aid & salt indicators, child lock option, washing cycle indicators, half load option (with three modes: lower basket / upper basket / half load on both baskets), display (remaining time, delay timer), delay timer (1-2-3-...-24hr), 3in1 tablet detergent option, extra silent option, extra fast option, energy save option.

T25: 8 programs, rinse-aid & salt indicators, child lock option, washing cycle indicators, half load option (with three modes: lower basket / upper basket / half load on both baskets), display (remaining time, delay timer), delay timer (1-2-3-...-24hr), 3in1 tablet detergent option, extra silent option, extra fast option, energy save option. option, energy save button

## Programs

| SEMI-INTEGRATED T3X (LED) 60cm Models | T31 | T32 | T34               | T35               |
|---------------------------------------|-----|-----|-------------------|-------------------|
| Prewash                               | Yes | Yes | -                 | -                 |
| Eco 50°C                              | Yes | Yes | Yes               | Yes               |
| Jet Wash 18'                          | Yes | Yes | Yes               | Yes               |
| Quick 30' 40°C                        | Yes | Yes | Yes               | Yes               |
| Super 50' 65°C                        | Yes | Yes | Yes               | Yes               |
| Dual Pro Wash 60°C                    | -   | -   | Yes               | Yes               |
| Hygiene 70°C                          | -   | -   | Yes               | Yes               |
| Auto Delicate 30°C - 50°C             | -   | Yes | Yes               | Yes               |
| Auto Normal 50°C - 60°C               | -   | Yes | -                 | -                 |
| Auto Intensive 60°C - 70°C            | Yes | Yes | Yes (50°C - 70°C) | Yes (50°C - 70°C) |

| SEMI-INTEGRATED T SERIES 60cm Models | T11 | T12 | T13 | T21 | T24             | T25             |
|--------------------------------------|-----|-----|-----|-----|-----------------|-----------------|
| Prewash                              | -   | -   | Yes | Yes | -               | -               |
| Jet Wash 18'                         | -   | -   | -   | -   | Yes             | Yes             |
| Eco 50°C                             | Yes | Yes | Yes | Yes | Yes             | Yes             |
| Intensive 65°C                       | Yes | Yes | Yes | -   | -               | -               |
| Quick 30' 40°C                       | -   | Yes | Yes | Yes | Yes             | Yes             |
| Super 50' 65 °C                      | Yes | Yes | Yes | Yes | Yes             | Yes             |
| Delicate 40°C                        | -   | -   | Yes | -   | -               | -               |
| Daily 60°C                           | -   | -   | -   | Yes | -               | -               |
| Auto Delicate 30°C - 50°C            | -   | -   | -   | Yes | Yes             | Yes             |
| Auto Normal 50°C - 60°C              | -   | -   | -   | Yes | -               | -               |
| Auto Intensive 60°C - 70°C           | -   | -   | -   | Yes | Yes (50°C-70°C) | Yes (50°C-70°C) |
| Hygiene 70°C                         | -   | -   | -   | -   | Yes             | Yes             |
| Dual Pro Wash 60°C                   | -   | -   | -   | -   | Yes             | Yes             |



Y Series



**Y24:**  
9 programs, rinse-aid & salt indicators, child lock option, washing cycle indicators, half load option (with three modes: lower basket / upper basket / half load on both baskets), display (remaining time, delay timer), delay timer (1-2-3-...-19hr), 3in1 tablet detergent option, extra hygiene option, extra dry option, extra rinse option

**Y22:**  
7 programs, rinse-aid & salt indicators, child lock option, washing cycle indicators, half load option (with three modes: lower basket / upper basket / half load on both baskets), display (remaining time, delay timer), delay timer (1-2-3-...-19hr), 3in1 tablet detergent option, extra hygiene option, extra dry option, extra rinse option

**Y23:**  
8 programs, rinse-aid & salt indicators, child lock option, washing cycle indicators, half load option (with three modes: lower basket / upper basket / half load on both baskets), display (remaining time, delay timer), delay timer (1-2-3-...-19hr), 3in1 tablet detergent option, extra hygiene option, extra dry option, extra rinse option

**Y21:**  
6 programs, rinse-aid & salt indicators, child lock option, washing cycle indicators, half load option (with three modes: lower basket / upper basket / half load on both baskets), display (remaining time, delay timer), delay timer (1-2-3-...-19hr), 3in1 tablet detergent option, extra hygiene option, extra dry option, extra rinse option



**Y15:**  
6 programs, rinse-aid & salt indicators, washing cycle indicators, half load option (with one mode), delay timer (3-6-9hr)

**Y14:**  
5 programs, rinse-aid & salt indicators, washing cycle indicators, half load option (with one mode), delay timer (3-6-9hr)

**Y13:**  
4 programs, rinse-aid & salt indicators, washing cycle indicators, half load option (with one mode), delay timer (3-6-9hr)

**Y12:**  
3 programs, rinse-aid & salt indicators, washing cycle indicators, half load option (with one mode), delay timer (3-6-9hr)

**Y11:**  
2 programs, rinse-aid & salt indicators, washing cycle indicators, half load option (with one mode), delay timer (3-6-9hr)



Extra features with display (Y1A & Y1F):

Child lock option, display (remaining time, delay timer), delay timer (1-2-3-...-19hr), 3in1 tablet detergent option, extra hygiene option, extra dry option, extra rinse option

Programs

| SEMI-INTEGRATED Y SERIES 60cm Models* | Y11 - Y1A | Y12 - Y1B | Y13 - Y1C | Y14 - Y1D | Y15 - Y1E | Y1F | Y21 | Y22 | Y23 | Y24 |
|---------------------------------------|-----------|-----------|-----------|-----------|-----------|-----|-----|-----|-----|-----|
| Prewash                               | -         | -         | -         | -         | Yes       | Yes | Yes | Yes | Yes | Yes |
| Eco                                   | Yes       | Yes       | Yes       | Yes       | Yes       | Yes | Yes | Yes | Yes | Yes |
| Intensive 65°C                        | Yes       | Yes       | Yes       | Yes       | Yes       | Yes | Yes | Yes | Yes | Yes |
| Quick 30' 40°C                        | -         | -         | Yes       | Yes       | Yes       | Yes | Yes | Yes | Yes | Yes |
| Super 50' 65°C                        | -         | Yes       | Yes       | Yes       | Yes       | Yes | Yes | Yes | Yes | Yes |
| Super 55' 60°C                        | -         | -         | -         | -         | -         | -   | -   | -   | -   | -   |
| Delicate 40°C                         | -         | -         | -         | -         | -         | Yes | Yes | Yes | Yes | -   |
| Normal 55°C                           | -         | -         | -         | -         | -         | -   | -   | Yes | Yes | -   |
| Auto Delicate 30°C - 50°C             | -         | -         | -         | -         | -         | -   | -   | -   | -   | Yes |
| Auto Normal 50°C - 60°C               | -         | -         | -         | -         | -         | -   | -   | -   | -   | Yes |
| Auto Intensive 60°C - 70°C            | -         | -         | -         | -         | -         | -   | -   | -   | -   | Yes |
| Hygiene 70°C                          | -         | -         | -         | Yes       | Yes       | Yes | -   | -   | Yes | Yes |

\*: Y1A-F: with display versions

## X&amp;C Series



**C41:**  
9 programs, rinse-aid & salt indicators, child lock option, washing cycle indicators, half load option (with three modes: lower basket / upper basket / half load on both baskets), display (remaining time, delay timer), delay timer (1-2-3-...-19hr), prewash button



**C31:**  
7 programs, rinse-aid & salt indicators, child lock option, washing cycle indicators, half load option (with three modes: lower basket / upper basket / half load on both baskets), delay timer (3-6-9-12hr), prewash button



**C21:**  
6 programs, rinse-aid & salt indicators, child lock option, washing cycle indicators, delay timer (3-6-9-12hr), prewash button



**X16:**  
7 programs, rinse-aid & salt indicators, washing cycle indicators, half load option (with one mode), delay timer (3-6-9hr)

**X15:**  
6 programs, rinse-aid & salt indicators, washing cycle indicators, half load option (with one mode), delay timer (3-6-9hr)

**X14, X13, X12, X11:**  
5, 4, 3, 2 programs, rinse-aid & salt indicators, washing cycle indicators, half load option (with one mode), delay timer (3-6-9hr)



Extra features with display (X1A-F):

Child lock option, display (remaining time, delay timer), delay timer (1-2-3-...-19hr)

## Programs

| SEMI-INTEGRATED X&C SERIES 60cm Models**               | X11 - X1A | X12 - X1B | X13 - X1C | X14 - X1D | X15 - X1E | X16 - X1F | C21  | C31  | C41  |
|--|-----------|-----------|-----------|-----------|-----------|-----------|------|------|------|
| Prewash  | -         | -         | -         | -         | Yes       | Yes       | Yes* | Yes* | Yes* |
| Eco 50°C   | Yes       | Yes       | Yes       | Yes       | Yes       | Yes       | Yes  | Yes  | Yes  |
| Intensive 65°C   | Yes       | Yes       | Yes       | Yes       | Yes       | Yes       | Yes  | Yes  | -    |
| Quick 30' 40°C   | -         | -         | Yes       | Yes       | Yes       | Yes       | Yes  | Yes  | Yes  |
| Super 50' 65°C   | -         | Yes       | Yes       | Yes       | Yes       | Yes       | Yes  | Yes  | -    |
| Super 55' 60°C   | -         | -         | -         | -         | -         | -         | -    | -    | Yes  |
| Delicate 40°C  | -         | -         | -         | -         | -         | Yes       | -    | Yes  | -    |
| Auto Delicate 30°C - 50°C                              | -         | -         | -         | -         | -         | -         | -    | -    | Yes  |
| Auto Normal 50°C - 60°C                                | -         | -         | -         | -         | -         | -         | -    | -    | Yes  |
| Auto Intensive 60°C - 70°C                             | -         | -         | -         | -         | -         | -         | -    | -    | Yes  |
| Hygiene 60°C   | -         | -         | -         | -         | -         | -         | -    | -    | Yes  |
| Hygiene 70°C   | -         | -         | -         | Yes       | Yes       | Yes       | -    | -    | -    |
| Extra Intensive 70°C (Prewash Button + Intensive 65°C) | -         | -         | -         | -         | -         | -         | Yes  | Yes  | -    |
| Extra Hygiene 70°C (Prewash Button + Hygiene 60°C)     | -         | -         | -         | -         | -         | -         | -    | -    | Yes  |

\*: Seperate function button

\*\* : X1A-F: with display versions

**D Series**



D53: 8+ programs, touch panel, rinse-aid & salt indicators, audible signal (buzzer at the end programme), half load option (with three modes: lower basket / upper basket / half load on both baskets), display (remaining time, delay timer), delay timer (1-2-3-...-19hr), 3in1 tablet detergent option, extra silent option, extra fast option, energy save option, InfoLED (optional)



D52: 8+ programs, touch panel, rinse-aid & salt indicators, audible signal (buzzer at the end programme), half load option (with three modes: lower basket / upper basket / half load on both baskets), display (remaining time, delay timer), delay timer (1-2-3-...-19hr), 3in1 tablet detergent option, extra rinse option, InfoLED (optional)



D51: 6 programs, touch panel, rinse-aid & salt indicators, audible signal (buzzer at the end programme), half load option (with one mode), display (remaining time, delay timer), delay timer (1-2-3-...-19hr), 3in1 tablet detergent option, InfoLED (optional)

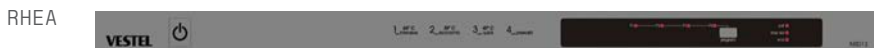

D41: 9+ programs, rinse-aid & salt indicators, end of cycle indicator, audible signal (buzzer at the end programme), half load option (with three modes: lower basket / upper basket / half load on both baskets), display (remaining time, delay timer), delay timer (1-2-3-...-19hr), 3in1 tablet detergent option, prewash button

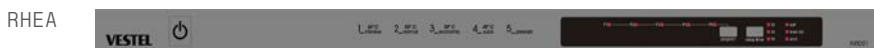

D21: 5 programs, rinse-aid & salt indicators, end of cycle indicator, audible signal (buzzer at the end programme), delay timer (3-6-9hr)



D13: 4 programs, rinse-aid & salt indicators, end of cycle indicator, audible signal (buzzer at the end programme)

**Programs**

| FULLY-INTEGRATED 60cm Models                       | D13 | D21 | D41 | D51 | D52 | D53             |
|--|-----|-----|-----|-----|-----|-----------------|
| Prewash  | Yes | Yes | Yes | -   | -   | -               |
| Mini 18'   | -   | -   | -   | Yes | Yes | Yes             |
| Eco 50°C   | Yes | Yes | Yes | Yes | Yes | Yes             |
| Intensive 65°C                                     | Yes | -   | -   | Yes | -   | -               |
| Intensive 70°C                                     | -   | Yes | -   | -   | -   | -               |
| Quick 30' 40°C                                     | -   | Yes | Yes | Yes | Yes | Yes             |
| Super 50' 65°C                                     | Yes | Yes | -   | Yes | Yes | Yes             |
| Super 55' 60°C                                     | -   | -   | Yes | -   | -   | -               |
| Auto Delicate 30°C - 50°C                          | -   | -   | Yes | -   | Yes | Yes             |
| Auto Normal 50°C - 60°C                            | -   | -   | Yes | -   | Yes | -               |
| Auto Intensive 60°C - 70°C                         | -   | -   | Yes | -   | Yes | Yes (50°C-70°C) |
| Hygiene 60°C                                       | -   | -   | Yes | Yes | Yes | Yes             |
| Extra Hygiene 70°C (Prewash Button + Hygiene 60°C) | -   | -   | Yes | -   | -   | -               |

Semi-Integrated Panel Color Options

WHITE



BLACK

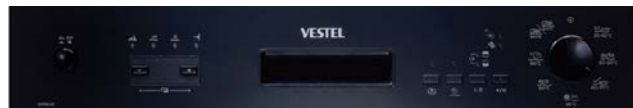

INOX

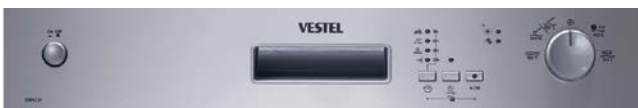

ALUMINIUM LOOK



DARK SILVER



WHITE



BLACK



WHITE



BLACK



DARK SILVER



Fully-Integrated Panel Color Options

WHITE



BLACK



DARK SILVER



For each aesthetics, please ask for different color options.

## T35 Ares

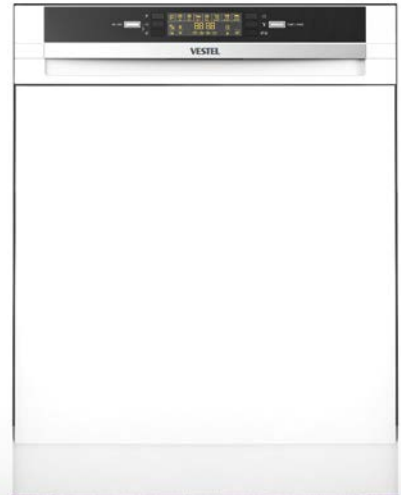

### STANDARD FEATURES

- 14 place settings
- 8 programs, 6+ temperatures
- Rinse aid & salt indicators
- Washing cycle indicators
- Child lock option
- Overflow and leakage protection
- Heater protection
- Half load option (with three modes) (lower basket/upper basket /half load on both baskets)
- Display (remaining time, delay timer)
- Delay timer (1-2-3-...-24hr)
- 3in1 tablet detergent option
- Extra silent option
- Extra fast option
- Energy save option
- Auto door technology
- Water box technology
- Overflow and leakage protection
- Heater protection
- 9 lt water consumption

### PERFORMANCE

A+++AA -%20, 44 dB(A)\*

### COLOR OPTIONS

White / Black / Dark Silver

A+++ -20%



\* Patara is also available

## T34 Ares

### STANDARD FEATURES

- 12 / 15 place settings
- 8 programs, 6+ temperatures
- Rinse aid & salt indicators
- Washing cycle indicators
- Child lock option
- Overflow and leakage protection
- Heater protection
- Half load option (with three modes) (lower basket/upper basket /half load on both baskets)
- Display (remaining time, delay timer)
- Delay timer (1-2-3-...-24hr)
- 3in1 tablet detergent option
- Extra silent option
- Extra fast option
- Energy save option
- Auto door technology
- 9 lt water consumption

### PERFORMANCE

A+++AA, 46 dB(A), 12ps\*  
A+++AA, 44 dB(A), 15ps

### COLOR OPTIONS

White / Black / Dark Silver

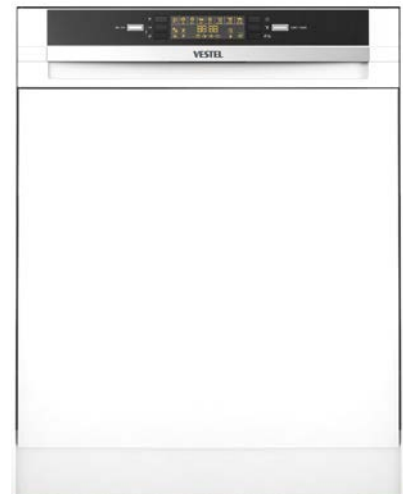

\* Patara is also available

A+++

\* 13 PS will be also available as an option on May 2017.



## T32 Patara

### STANDARD FEATURES

12 / 15 place settings  
 8 programs , 6+ temperatures  
 Rinse aid & salt indicators  
 Washing cycle indicators  
 Child lock option  
 Overflow and leakage protection  
 Heater protection  
 Half load option (with three modes)  
 (lower basket/upper basket /half load  
 on both baskets)  
 Display (remaining time, delay timer)  
 Delay timer (1-2-3-...-24hr)  
 3in1 tablet detergent option  
 Extra hygiene option  
 Extra dry option  
 9 lt water consumption

### PERFORMANCE

A+++AA, 54/52/49/47/45 dB(A)\*

### COLOR OPTIONS

White / Black / Dark Silver

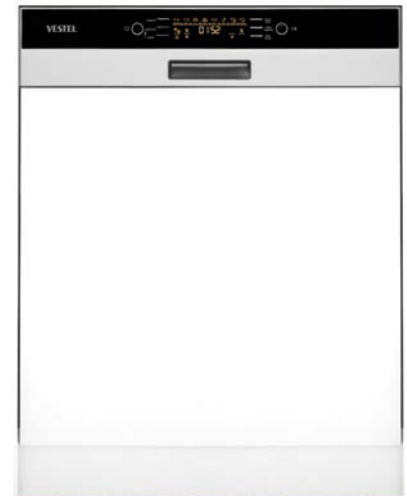

\* Ares is also available

A++

## T31 Patara

### STANDARD FEATURES

12 / 15 place settings  
 6 programs, 6+ temperatures  
 Rinse aid & salt indicators  
 Washing cycle indicators  
 Child lock option  
 Overflow and leakage protection  
 Heater protection  
 Half load option (with three modes)  
 (lower basket/upper basket /half load  
 on both baskets)  
 Display (remaining time, delay timer)  
 Delay timer (1-2-3-...-24hr)  
 3in1 tablet detergent option  
 Extra hygiene option  
 Extra dry option  
 9 lt water consumption

### PERFORMANCE

A+++AA, 54/52/49/47/45 dB(A)\*

### COLOR OPTIONS

White / Black / Dark Silver



A++

\* Ares is also available

\* 13 PS will be also available as an option on May 2017.

## T25 Amaranth



### STANDARD FEATURES

- 14 place settings
- 8 programs, 6+ temperatures
- Rinse aid & salt indicators
- Washing cycle indicators
- Child lock option
- Overflow and leakage protection
- Heater protection
- Half load option (with three modes)  
(lower basket/upper basket /half load on both baskets)
- Display (remaining time, delay timer)
- Delay timer (1-2-3-...-24hr)
- 3in1 tablet detergent option
- Extra silent option
- Extra fast option
- Energy save option
- Auto door technology
- Water box technology
- 9 lt water consumption
- Structures

### PERFORMANCE

A+++AA -%20, 44 dB(A)\*

### COLOR OPTIONS

White / Black / Dark Silver

A+++ -20%



## T24 Amaranth

### STANDARD FEATURES

- 12 / 15 place settings
- 8 programs, 6+ temperatures
- Rinse aid & salt indicators
- Washing cycle indicators
- Child lock option
- Overflow and leakage protection
- Heater protection
- Half load option (with three modes)  
(lower basket/upper basket /half load on both baskets)
- Display (remaining time, delay timer)
- Delay timer (1-2-3-...-24hr)
- 3in1 tablet detergent option
- Extra silent option
- Extra fast option
- Energy save option
- Auto door technology
- 9 lt water consumption

### PERFORMANCE

A+++AA, 46 dB(A), 12ps\*  
A+++AA, 44 dB(A), 15ps

### COLOR OPTIONS

White / Black / Dark Silver



A+++

\* 13 PS will be also available as an option on May 2017.

## T21 Amaranth

### STANDARD FEATURES

12 / 15 place settings  
 8 programs , 6+ temperatures  
 Rinse aid & salt indicators  
 Washing cycle indicators  
 Child lock option  
 Overflow and leakage protection  
 Heater protection  
 Half load option (with three modes)  
 (lower basket/upper basket /half load  
 on both baskets)  
 Display (remaining time, delay timer)  
 Delay timer (1-2-3-...-24hr)  
 3in1 tablet detergent option  
 Extra hygiene option  
 Extra dry option  
 Extra rinse option  
 9 lt water consumption

### PERFORMANCE

A++AA, 54/52/49/47/45 dB(A)\*

### COLOR OPTIONS

White / Black / Dark Silver



A++

## T13 Amaranth

### STANDARD FEATURES

12 place settings  
 6 programs, 3 temperatures  
 Rinse aid & salt indicators  
 Washing cycle indicators  
 Child lock option  
 Overflow and leakage protection  
 Heater protection  
 Half load option (with one mode)  
 Display (remaining time, delay timer)  
 Delay timer (1-2-3-...-24hr)  
 3in1 tablet detergent option  
 Extra hygiene option  
 12 lt water consumption

### PERFORMANCE

A++AA, 57/54/52/49/47/45 dB(A)\*

### COLOR OPTIONS

White / Black / Dark Silver



A++

\* 13 PS will be also available as an option on May 2017.

## T12 Amaranth



### STANDARD FEATURES

- 12 place settings
- 4 programs, 3 temperatures
- Rinse aid & salt indicators
- Washing cycle indicators
- Child lock option
- Overflow and leakage protection
- Heater protection
- Half load option (with one mode)
- Display (remaining time, delay timer)
- Delay timer (1-2-3-...-24hr)
- 12 lt water consumption

### PERFORMANCE

A++AA, 57/54/52/49/47/45 dB(A)\*

### COLOR OPTIONS

White / Black / Dark Silver



## T11 Amaranth

### STANDARD FEATURES

- 12 place settings
- 3 programs, 2 temperatures
- Rinse aid & salt indicators
- Washing cycle indicators
- Child lock option
- Overflow and leakage protection
- Heater protection
- Half Load Option (with one mode)
- 12 lt water consumption

### PERFORMANCE

A++AA, 57/54/52/49/47/45 dB(A)\*

### COLOR OPTIONS

White / Black / Dark Silver

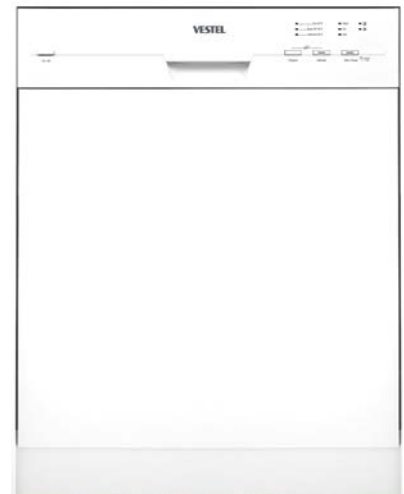

\* 13 PS will be also available as an option on May 2017.

## Y24 Silva

### STANDARD FEATURES

12 / 15 place settings  
 9 programs, 7+ temperatures  
 Rinse aid & salt indicators  
 Washing cycle indicators  
 Child lock option  
 Overflow and leakage protection  
 Heater protection  
 Half load option (with three modes)  
 (lower basket/upper basket /half load  
 on both baskets)  
 Display (delay timer, remaining time)  
 Delay timer (1-2-3-...-19hr)  
 3in1 tablet detergent option  
 Extra hygiene option  
 Extra rinse option  
 Extra dry option  
 9 lt water consumption

### PERFORMANCE

A++AA, 54/52/49/47/45 dB(A)\*

### COLOR OPTIONS

White / Black / Dark Silver



\* Camelia is also available

A++

## Y23 Camelia

### STANDARD FEATURES

12 / 15 place settings  
 8 programs, 5 temperatures  
 Rinse aid & salt indicators  
 Washing cycle indicators  
 Child lock option  
 Overflow and leakage protection  
 Heater protection  
 Half load option (with three modes)  
 (lower basket/upper basket /half load  
 on both baskets)  
 Display (delay timer, remaining time)  
 Delay timer (1-2-3-...-19hr)  
 3in1 tablet detergent option  
 Extra hygiene option  
 Extra rinse option  
 Extra dry option  
 9 lt water consumption

### PERFORMANCE

A++AA, 54/52/49/47/45 dB(A)\*

### COLOR OPTIONS

White / Black / Dark Silver



\* Silva is also available

A++



## Y22 Camelia



### STANDARD FEATURES

- 12 / 15 place settings
- 7 programs, 4 temperatures
- Rinse aid & salt indicators
- Washing cycle indicators
- Child lock option
- Overflow and leakage protection
- Heater protection
- Half load option (with three modes)  
(lower basket/upper basket /half load on both baskets)
- Display (delay timer, remaining time)
- Delay timer (1-2-3-...-19hr)
- 3in1 tablet detergent option
- Extra hygiene option
- Extra rinse option
- Extra dry option
- 9 lt water consumption

### PERFORMANCE

A++AA, 57/54/52/49/47/45 dB(A)\*

### COLOR OPTIONS

White / Black / Dark Silver



\* Silva is also available

## Y21 Silva

### STANDARD FEATURES

- 12 / 15 place settings
- 6 programs, 3 temperatures
- Rinse aid & salt indicators
- Washing cycle indicators
- Child lock option
- Overflow and leakage protection
- Heater protection
- Half load option (with three modes)  
(lower basket/upper basket /half load on both baskets)
- Display (delay timer, remaining time)
- Delay timer (1-2-3-...-19hr)
- 3in1 tablet detergent option
- Extra hygiene option
- Extra rinse option
- Extra dry option
- 9 lt water consumption

### PERFORMANCE

A++AA, 57/54/52/49/47/45 dB(A)\*

### COLOR OPTIONS

White / Black / Dark Silver



\* Camelia is also available



\* 13 PS will be also available as an option on May 2017.

## Y11-5 & Y1A-F *with display*

### STANDARD FEATURES

12 place settings  
 2 / 3 / 4 / 5 / 6 / 7 programs, 2 / 3 / 4 temperatures  
 Rinse aid & salt indicators  
 Washing cycle indicators  
 Overflow and leakage protection  
 Heater protection  
 Half load option (with one mode)  
 Delay timer (3-6-9hr)  
 12 lt water consumption

### EXTRA FEATURES WITH DISPLAY

Child lock option  
 Display (remaining time, Delay timer)  
 Delay timer (1-2-3-...-19hr)  
 3in1 tablet detergent option  
 Extra hygiene option  
 Extra rinse option  
 Extra dry option

### PERFORMANCE

A++AA, 57/54/52/49/47/45 dB(A)\*

### COLOR OPTIONS

White / Black / Dark Silver

\* Silva and Camelia aesthetics available



## D53 Freya



### STANDARD FEATURES

- 15 place settings
- Hidden control panel
- Touch panel
- 8+ programs, 6+ temperatures
- Rinse aid & salt indicators
- Overflow and leakage protection
- Heater protection
- Audible signal (buzzer at the end programme)
- Half load option (with three modes) (lower basket/upper basket /half load on both baskets)
- Display (delay timer, remaining time)
- Delay timer (1-2-3-...-19hr)
- 3in1 tablet detergent button
- Energy save option
- Extra silent option
- Extra fast option
- InfoLED (optional)
- 9 lt water consumption

### PERFORMANCE

A++AA, 44 dB(A)

### COLOR OPTIONS

Black



A++

## D52 Freya

### STANDARD FEATURES

- 12 / 15 place settings
- Hidden control panel
- Touch panel
- 8+ programs, 6+ temperatures
- Rinse aid & salt indicators
- Overflow and leakage protection
- Heater protection
- Audible signal (buzzer) at the end program
- Half load option (with three modes) (lower basket/upper basket /half load on both baskets)
- Display (delay timer, remaining time)
- Delay timer (1-2-3-...-19hr)
- 3in1 tablet detergent button
- Extra rinse option
- 9 lt water consumption
- InfoLED (optional)

### PERFORMANCE

A++AA, 54/52/49/47/45 dB(A)\*

### COLOR OPTIONS

Black



A++

\* 13 PS will be also available as an option on May 2017.

## D51 Freya

### STANDARD FEATURES

- 12 place settings
- Hidden control panel
- Touch panel
- 6 programs, 3 temperatures
- Rinse aid & salt indicators
- Overflow and leakage protection
- Heater protection
- Audible signal (buzzer) at the end of program
- Half load option (with one mode)
- Display (delay timer, remaining time)
- Delay timer (1-2-3-...-19hr)
- 3in1 tablet detergent button
- 12 lt water consumption
- InfoLED (optional)

### PERFORMANCE

A++AA, 57/54/52/49/47/45 dB(A)\*

### COLOR OPTIONS

Black



A++



## D41 Rhea

### STANDARD FEATURES

- 12 / 15 place settings
- Hidden control panel
- Standard or membrane button
- 9+ programs, 6+ temperatures
- Rinse aid & salt indicators
- End of cycle indicator
- Overflow and leakage protection
- Heater protection
- Audible signal (buzzer) at the end of program
- Half load option (with three modes) (lower basket/upper basket /half load on both baskets)
- Display (delay timer, remaining time)
- Delay timer (1-2-3-...-19hr)
- 3in1 tablet detergent button
- Prewash button
- 9 lt water consumption

### PERFORMANCE

A++AA, 54/52/49/47/45 dB(A)\*

### COLOR OPTIONS

White / Black / Dark Silver

\* Astrum is also available



A++

\* 13 PS will be also available as an option on May 2017.

## D21 Rhea



### STANDARD FEATURES

- 12 place settings
- Hidden control panel
- Standard or membrane button
- 5 programs, 4 temperatures
- Rinse aid & salt indicators
- End of cycle indicator
- Overflow and leakage protection
- Heater protection
- Audible signal (buzzer) at the end of program
- Delay timer (3-6-9hr)
- 12 lt water consumption

### PERFORMANCE

A++AA, 57/54/52/49/47/45 dB(A)\*

### COLOR OPTIONS

White / Black / Dark Silver

\* Astrum is also available

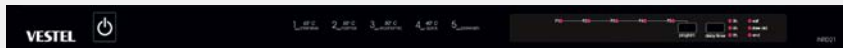

## D13 Rhea

### STANDARD FEATURES

- 12 place settings
- Hidden control panel
- Standard or membrane button
- 4 programs, 2 temperatures
- Rinse aid & salt indicators
- End of cycle Indicator
- Overflow and leakage protection
- Heater protection
- Audible signal (buzzer) at the end of program
- 12 lt water consumption

### PERFORMANCE

A++AA, 57/54/52/49/47/45 dB(A)\*

### COLOR OPTIONS

White / Black / Dark Silver

\* Astrum is also available



\* 13 PS will be also available as an option on May 2017.



## C41 Camelia

### STANDARD FEATURES

12 / 15 place settings  
 9 programs, 6+ temperatures  
 Rinse aid & salt indicators  
 Washing cycle indicators  
 Child lock option  
 Overflow and leakage protection  
 Heater protection  
 Half load option (with three modes)  
 (lower basket/upper basket /half load  
 on both baskets)  
 Display (delay timer, remaining time)  
 Delay timer (1-2-3-...-19hr)  
 3in1 tablet detergent option  
 Prewash button  
 9 lt water consumption

### PERFORMANCE

A++AA, 54/52/49/47/45 dB(A)\*

### PANEL ADD ON MATERIAL

White / Black / Aluminium look lexan,  
 inox sheet



\* Silva is also available

A++

## C31 Camelia

### STANDARD FEATURES

12 / 13 place settings  
 7 programs, 4 temperatures  
 Rinse aid & salt indicators  
 Washing cycle indicators  
 Child lock option  
 Overflow and leakage protection  
 Heater protection  
 Half load option (with three modes)  
 (lower basket/upper basket /half load  
 on both baskets)  
 Delay timer (3-6-9-12hr)  
 Prewash button  
 9 lt water consumption

### PERFORMANCE

A++AA, 54/52/49/47/45 dB(A)\*

### PANEL ADD ON MATERIAL

White / Black / Aluminium look lexan,  
 inox sheet



\* Silva is also available

A++

## C21 Silva



### STANDARD FEATURES

- 12 place settings
- 6 programs, 4 temperatures
- Rinse aid & salt indicators
- Washing cycle indicators
- Child lock option
- Overflow and leakage protection
- Heater protection
- Delay timer (3-6-9-12hr)
- Prewash button
- 12 lt water consumption

### PERFORMANCE

A++AA, 57/54/52/49/47/45 dB(A)

### PANEL ADD ON MATERIAL

White / Black / Aluminium look lexan, inox sheet

\* Camelia is also available

A++

## X11-6 & X1A-F with display Silva

### STANDARD FEATURES

- 12 place settings
- 2 / 3 / 4 / 5 / 6 / 7 programs, 3 / 4 temperatures
- Rinse aid & salt indicators
- Washing cycle indicators
- Overflow and leakage protection
- Heater protection
- Half load option (with one mode)
- Delay timer (3-6-9hr)
- 12 lt water consumption

### EXTRA FEATURES WITH DISPLAY

- Child lock option
- Display (remaining time, Delay timer)
- Delay timer (1-19hr)

### PERFORMANCE

A++AA, 57/54/52/49/47/45 dB(A)

### PANEL ADD ON MATERIAL

White / Black / Aluminium look lexan, inox sheet

\* Silva and Camelia aesthetics available

\* Half-load option and Rinse aid/ Salt indicator must be selected together



A++

SEMI-INTEGRATED

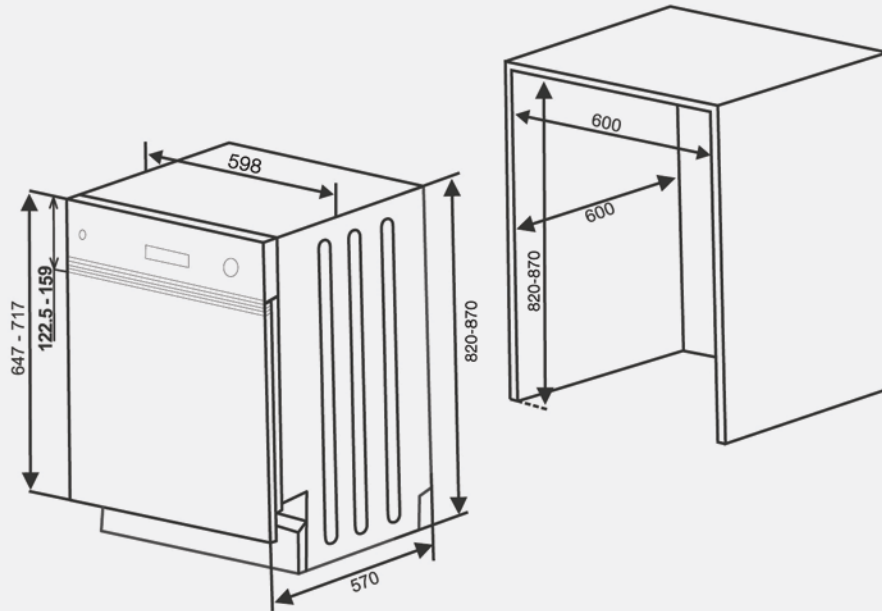

FULLY-INTEGRATED

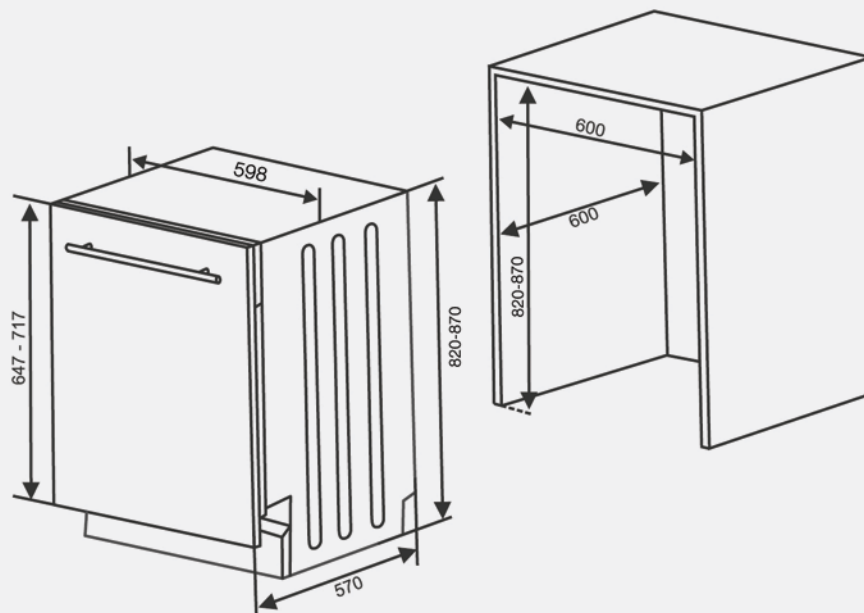

# 45 cm Dishwashers



**A+++AA/ A++AA Class**

Top class ratings for “energy consumption”, “cleaning & drying performance”. The minimum energy class is A++ and the cleaning & drying performance is A for entire model range.

**MAXIMUM PLATE DIAMETER**

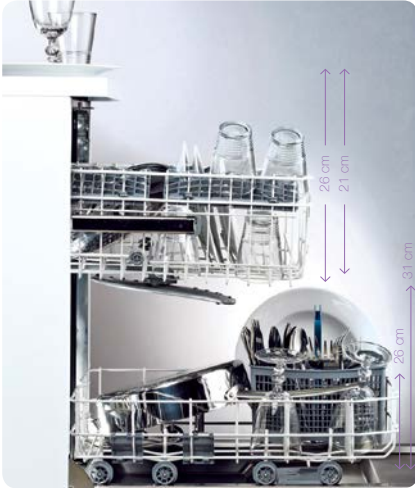

**STANDARD CUTLERY BASKET**



**ADJUSTABLE UPPER BASKET**



Adjustable only when empty

**LOWER BASKET - 10 PLACE SETTINGS**



**ADJUSTABLE BASKET**

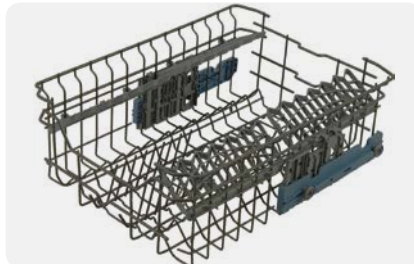

Adjustable only when loaded

| SEMI-INTEGRATED SLIM X&T SERIES 45cm Models* | X13 - X1C | X15 - X1E | T14 | T15 | T21 | T22 | T24               |
|--|-----------|-----------|-----|-----|-----|-----|-------------------|
| Prewash                                      | Yes       | Yes       | Yes | Yes | Yes | Yes | Yes               |
| Eco 50°C                                     | Yes       | Yes       | Yes | Yes | Yes | Yes | Yes               |
| Intensive 65°C                               | Yes       | Yes       | Yes | Yes | -   | -   | -                 |
| Quick 30' 40°C                               | -         | Yes       | Yes | Yes | Yes | Yes | Yes               |
| Super 50' 65°C                               | Yes       | Yes       | Yes | Yes | Yes | Yes | Yes               |
| Delicate 40°C                                | -         | -         | Yes | Yes | -   | -   | -                 |
| Dual Pro Wash 60°C                           | -         | -         | -   | -   | -   | -   | Yes               |
| Auto Delicate 30°C - 50°C                    | -         | -         | -   | -   | Yes | Yes | Yes               |
| Auto Normal 50°C - 60°C                      | -         | -         | -   | -   | Yes | Yes | -                 |
| Auto Intensive 60°C - 70°C                   | -         | -         | -   | -   | Yes | Yes | Yes (50°C - 70°C) |
| Hygiene 70°C                                 | -         | Yes       | Yes | Yes | Yes | Yes | Yes               |

\*: X1C & X1E: with display versions

| FULLY-INTEGRATED SLIM D SERIES 45cm Models | D12 | D22 | D32 | D42 | D41 | D51 | D52 | D53             |
|--|-----|-----|-----|-----|-----|-----|-----|-----------------|
| Prewash                                    | Yes | Yes | Yes | Yes | Yes | -   | -   | -               |
| Mini 18'                                   | -   | -   | -   | -   | -   | Yes | Yes | Yes             |
| Eco 50°C                                   | Yes | Yes | Yes | Yes | Yes | Yes | Yes | Yes             |
| Intensive 65°C                             | Yes | Yes | Yes | -   | -   | Yes | -   | -               |
| Quick 30' 40°C                             | -   | Yes | Yes | Yes | Yes | Yes | Yes | Yes             |
| Super 50' 65°C                             | -   | Yes | Yes | Yes | Yes | Yes | Yes | Yes             |
| Delicate 40°C                              | -   | -   | Yes | -   | -   | -   | -   | -               |
| Dual Pro Wash 60°C                         | -   | -   | -   | -   | -   | -   | -   | Yes             |
| Daily 60°C                                 | -   | -   | Yes | -   | -   | -   | -   | -               |
| Auto Delicate 30°C - 50°C                  | -   | -   | -   | Yes | Yes | -   | Yes | Yes             |
| Auto Normal 50°C - 60°C                    | -   | -   | -   | Yes | Yes | -   | Yes | -               |
| Auto Intensive 60°C - 70°C                 | -   | -   | -   | Yes | Yes | -   | Yes | Yes (50°C-70°C) |
| Hygiene 60°C                               | -   | -   | -   | -   | -   | Yes | Yes | Yes             |
| Hygiene 70°C                               | -   | Yes | Yes | Yes | Yes | -   | -   | -               |



**Semi-Integrated: T Series**



T14: 7 programs, rinse-aid & salt indicators, child lock washing cycle indicators, half load (with one mode), display (remaining time, delay timer 1-24h), 3in1 tablet detergent option, e. rinse option



T15: 7 programs, rinse-aid & salt indicators, child lock, washing cycle indicators, delay timer (3-6-9hr)



T21: 8 programs, rinse-aid & salt indicators, child lock washing cycle indicators, half load (with three modes: lower basket / upper basket / half load on both baskets), display (remaining time, delay timer 1,24h), 3in1 tablet detergent option, extra rinse option, extra drying option

T22: 8 programs, rinse-aid & salt indicators, child lock, washing cycle indicators, half load (with three modes: lower basket / upper basket / half load on both baskets), display (remaining time, delay timer 1-24), 3in1 tablet detergent option, extra rinse option, extra drying option

T24: 8 programs, rinse-aid & salt indicators, child lock, washing cycle indicators, half load (with three modes: lower basket / upper basket / half load on both baskets), display (remaining time, delay timer 1-24), extra silent option, extra fast option, energy save option

**Semi-Integrated: X Series**



X13: 4 programs, rinse-aid & salt indicators, washing cycle indicators, half load option (with one mode), delay timer (3-6-9hr)



X15: 6 programs, rinse-aid & salt indicators, washing cycle indicators, half load option (with one mode), delay timer (3-6-9hr)



Extra features with display (X1C & X1E): Child lock option, display (remaining time, delay timer), delay timer (1-2-3-...-19hr)

**Fully-Integrated: D Series**

D42: 8 programs, rinse-aid & salt indicators, end of cycle indicator, audible signal (buzzer) at the end program, half load option (with three modes: lower basket / upper basket / half load on both baskets), display (remaining time, delay timer), delay timer (1-2-3-...-19hr), 3in1 tablet detergent option



D41: 8 programs, rinse-aid & salt indicators, end of cycle indicator, audible signal (buzzer) at the end program, half load option (with three modes: lower basket / upper basket / half load on both baskets), display (remaining time, delay timer), delay timer (1-2-3-...-19hr), 3in1 tablet detergent option



D32: 8 programs, rinse-aid & salt indicators, end of cycle indicator, audible signal (buzzer) at the end program, half load option (with one mode), display (remaining time, delay timer), delay timer (1-2-3-...-19hr), 3in1 tablet detergent option

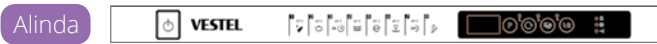

D22: 6 programs, rinse-aid & salt indicators, end of cycle indicator, audible signal (buzzer) at the end program, half load option (with one mode), delay timer (3-6-9hr)

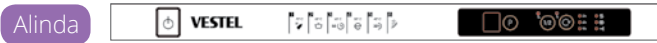

D12: 3 programs, rinse-aid & salt indicators, end of cycle indicator, audible signal (buzzer) at the end program



# 3<sup>rd</sup> Rack

## UPPER CUTLERY BASKET

The upper cutlery basket is designed to place forks, spoons and knives, long dippers and small items. You can take out the dishes along with the 3rd rack after washing. The Upper Cutlery Basket is composed of two pieces; You can take out left or right part of the upper cutlery basket to obtain more space for the dishes in the upper basket.



VarioSpace  
EasyTray

\*Cutlery plastic basket is optional.

## T24 Vento

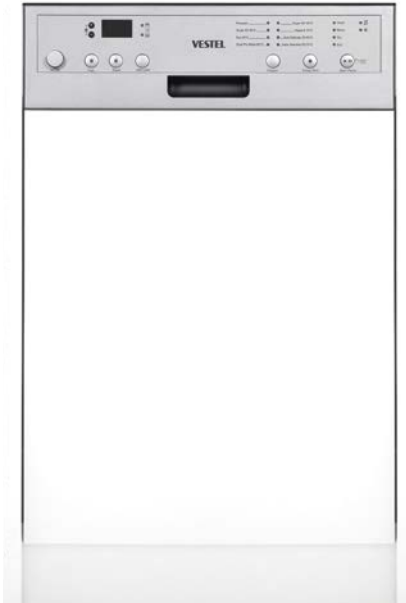

### STANDARD FEATURES

- 10 place settings
- 3<sup>rd</sup> Rack
- 8 programs, 7+ temperatures
- Rinse aid / salt indicator
- Washing cycle indicators
- Child lock option
- Overflow and leakage protection
- Heater protection
- Half load option (with three modes)  
(lower basket/upper basket /half load on both baskets)
- Display (remaining time, delay timer)
- Delay timer (1-2-3-...-24hr)
- Energy save option
- Extra silent option
- Extra fast option
- 9 lt water consumption

### PERFORMANCE

A+++AA, 44 dB(A)

### COLOR OPTIONS

White, Black, Dark Silver

A+++

## T22 Vento

### STANDARD FEATURES

- 10 place settings
- 3<sup>rd</sup> Rack is optional
- 8 programs, 7+ temperatures
- Rinse aid / salt indicator
- Washing cycle indicators
- Child lock option
- Overflow and leakage protection
- Heater protection
- Half load option (with three modes)  
(lower basket/upper basket /half load on both baskets)
- Display (remaining time, delay timer)
- Delay timer (1-2-3-...-24hr)
- 3in1 tablet detergent option
- Extra dry option
- Extra rinse option
- 9 lt water consumption

### PERFORMANCE

A++AA, 52/49/47/45 dB(A)

### COLOR OPTIONS

White, Black, Dark Silver

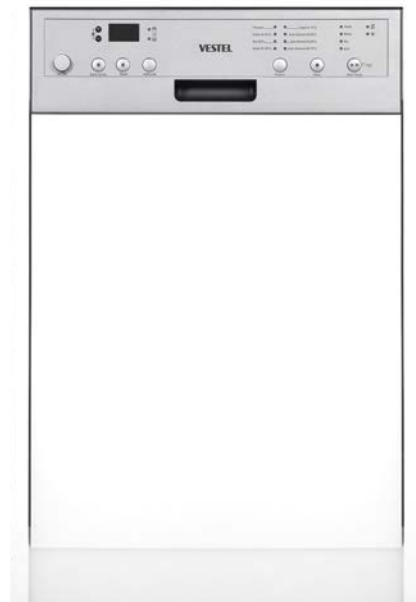

A++

## T21 Vento

### STANDARD FEATURES

10 place settings  
 8 programs, 7+ temperatures  
 Rinse aid / salt indicator  
 Washing cycle indicators  
 Child lock option  
 Overflow and leakage protection  
 Heater protection  
 Half load option (with three modes)  
 (lower basket/upper basket /half load  
 on both baskets)  
 Display (remaining time, delay timer)  
 Delay timer (1-2-3-...-24hr)  
 3in1 tablet detergent option  
 Extra dry option  
 Extra rinse option  
 9 lt water consumption

### PERFORMANCE

A++AA, 54/52/49/47/45 dB(A)\*

### COLOR OPTIONS

White, Black, Dark Silver

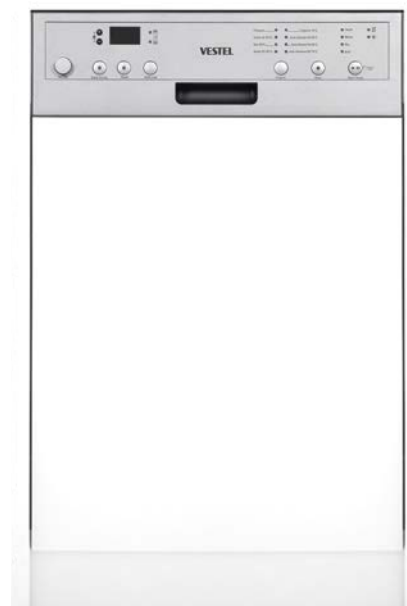

\* A+AA until April 2017

A++

## T15 Vento

### STANDARD FEATURES

10 place settings  
 7 programs, 4 temperatures  
 Rinse aid / salt indicator  
 Washing cycle indicators  
 Child lock option  
 Overflow and leakage protection  
 Heater protection  
 Delay timer (3-6-9hr)  
 Overflow and leakage protection  
 Heater protection  
 11 lt water consumption\*

### PERFORMANCE

A++AA, 57/54/52/49/47/45 dB(A)\*\*

### COLOR OPTIONS

White, Black, Dark Silver

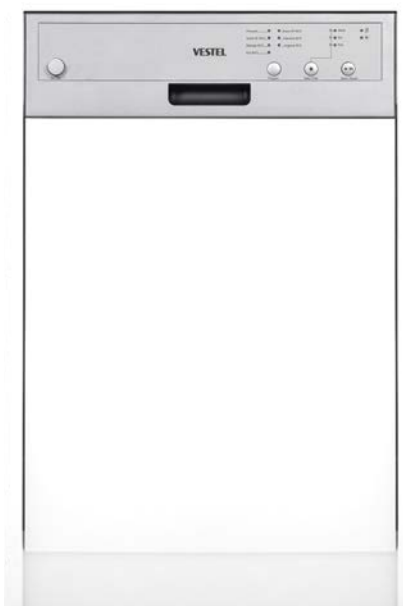

A++

\* 13 lt until April 2017

\*\* A+AA until April 2017

## T14 Vento

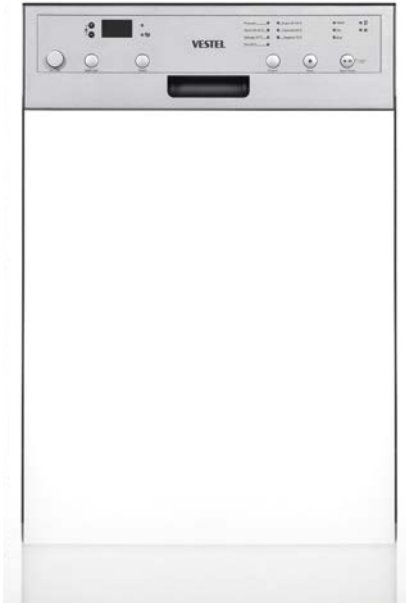

### STANDARD FEATURES

- 10 place settings
- 7 programs, 4 temperatures
- Rinse aid / salt indicator
- Washing cycle indicators
- Child lock option
- Overflow and leakage protection
- Heater protection
- Half load option (with one mode)
- Display (remaining time, delay timer)
- Delay timer (1-2-3-...-24hr)
- 3in1 tablet detergent option
- Extra rinse option
- 11 lt water consumption\*

### PERFORMANCE

A++AA, 57/54/52/49/47/45 dB(A)\*\*

### COLOR OPTIONS

White, Black, Dark Silver

\* 13 lt until April 2017

\*\* A+AA until April 2017

## X15 & X1E with display

### STANDARD FEATURES

- 10 place settings
- 6 programs, 4 temperatures
- Rinse aid / salt indicator
- Washing cycle indicators
- Overflow and leakage protection
- Heater protection
- Half load option (with one mode)
- Delay timer (3-6-9hr)
- 11 lt water consumption\*

### EXTRA FEATURES WITH DISPLAY

- Display (remaining time, delay timer)
- Delay timer (1-2-3-...-19hr)
- Child lock option

\* 13 lt until April 2017

### PERFORMANCE

A++AA, 57/54/52/49/47/45 dB(A)\*\*

### COLOR OPTIONS

a

\*\* A+AA until April 2017

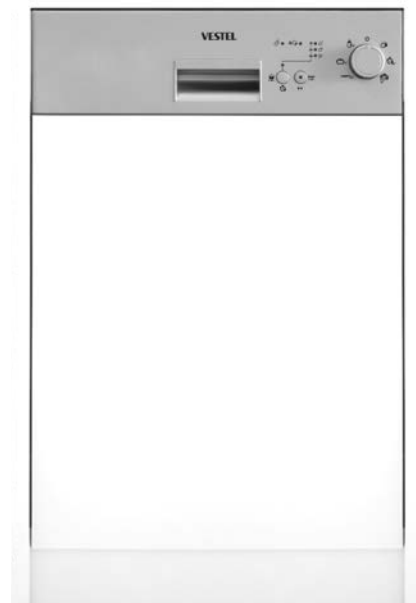



## X13 & X1C with display

### STANDARD FEATURES

10 place settings  
 4 programs, 2 temperatures  
 Rinse aid / salt indicator  
 Washing cycle indicators  
 Overflow and leakage protection  
 Heater protection  
 Half load option (with one mode)  
 Delay timer (3-6-9hr)  
 11 lt water consumption\*

### PERFORMANCE

A++AA, 57/54/52/49/47/45 dB(A)\*\*

### COLOR OPTIONS

White, Black, Dark Silver

### EXTRA FEATURES WITH DISPLAY

Display (remaining time, delay timer)  
 Delay timer (1-2-3-...-19hr)  
 Child lock option

\* 13 lt until April 2017

\*\* A+AA until April 2017

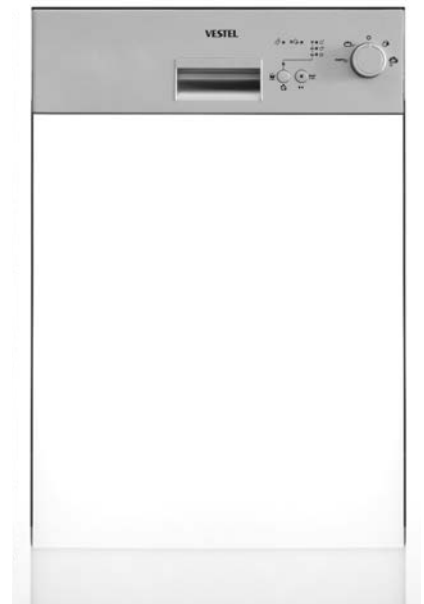

A++

## D53 - D52 - D51 Hemen

### STANDARD FEATURES

6-8 Programs  
 Touch Panel  
 Rinse-Aid & Salt Indicators  
 Audible Signal (Buzzer At The End Programme)  
 Half Load Option (With Three Modes: Lower Basket / Upper Basket / Half Load On Both Baskets) (D53&D52)  
 Half Load Option (With One Mode) (D51)  
 Display (Remaining Time, Delay Timer)  
 Delay Timer (1-2-3-...-19Hr)  
 3In1 Tablet Detergent Option  
 Extra Silent Option (D53)

Extra Fast Option (D53)  
 Energy Save Option(D53)  
 Extra Rinse Option(D52), Infoled (Optional)

### PERFORMANCE

D53: A+++AA, 44 dB(A)  
 D52: A++AA, 54/52/49/47/45 dB(A)  
 D51: A++AA, 57/54/52/49/47/45 dB(A)\*\*

\* 13 lt until April 2017

\*\* A+AA until April 2017



A+++

A++

## D41 Alinda



A<sup>++</sup>

### STANDARD FEATURES

- 10 place settings
- 3<sup>rd</sup> Rack
- 8 programs, 7+ temperatures
- Rinse aid / salt indicator
- End of cycle indicator
- Overflow and leakage protection
- Heater protection
- Audible signal (buzzer) at the end program
- Half load option (with three modes) (lower basket/upper basket /half load on both baskets)
- Display (remaining time, delay timer)
- Delay timer (1-2-3-...-19hr)
- 3in1 tablet detergent option
- 9 lt water consumption

### PERFORMANCE

A++AA, 52/49/47/45 dB(A)

\* Spero is also available



## D42 Spero

### STANDARD FEATURES

- 10 place settings
- 8 programs, 7+ temperatures
- Rinse aid / salt indicator
- End of cycle indicator
- Overflow and leakage protection
- Heater protection
- Audible signal (buzzer) at the end program
- Half load option (with three modes) (lower basket/upper basket /half load on both baskets)
- Display (remaining time, delay timer)
- Delay timer (1-2-3-...-19hr)
- 3in1 tablet detergent option
- 12 lt water consumption

### PERFORMANCE

A++AA, 52/49/47/45 dB(A)\*

\* Alinda is also available

\* A+AA until April 2017

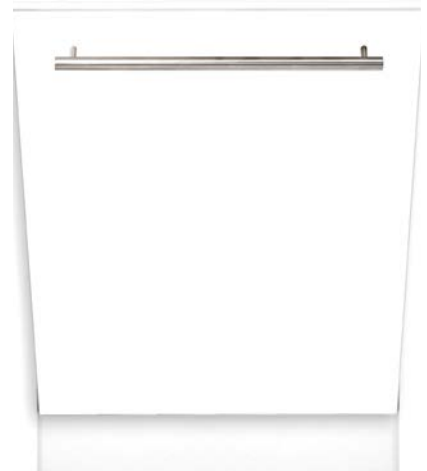

A<sup>++</sup>



## D32 Spero

### STANDARD FEATURES

- 10 place settings
- 8 programs, 6 temperatures
- Rinse aid / salt indicator
- End of cycle indicator
- Overflow and leakage protection
- Heater protection
- Audible signal (buzzer) at the end program
- Half load option (with one mode)
- Display (remaining time, delay timer)
- Delay timer (1-2-3-...-19hr)
- 3in1 tablet detergent option
- 11 lt water consumption\*

\* 13 lt until April 2017

### PERFORMANCE

A++AA, 57/54/52/49/47/45 dB(A)\*\*

\* Alinda is also available

\*\* A+AA until April 2017



## D22 Spero

### STANDARD FEATURES

- 10 place settings
- 6 programs, 4 temperatures
- Rinse aid / salt indicator
- End of cycle indicator
- Overflow and leakage protection
- Heater protection
- Audible signal (buzzer) at the end program
- Half load option (with one mode)
- Delay timer (3-6-9hr)
- 11 lt water consumption\*

\* 13 lt until April 2017

### PERFORMANCE

A++AA, 57/54/52/49/47/45 dB(A)\*\*

\* Alinda is also available

\*\* A+AA until April 2017





## D12 Spero

### STANDARD FEATURES

- 10 place settings
- 3 programs, 2 temperatures
- Rinse aid / salt indicator
- End of cycle indicator
- Overflow and leakage protection
- Heater protection
- Audible signal (buzzer) at the end program
- 11 lt water consumption\*

### PERFORMANCE

A++AA, 57/54/52/49/47/45 dB(A)\*\*

\* 13 lt until April 2017

\* Alinda is also available

\*\* A+AA until April 2017



SEMI-INTEGRATED

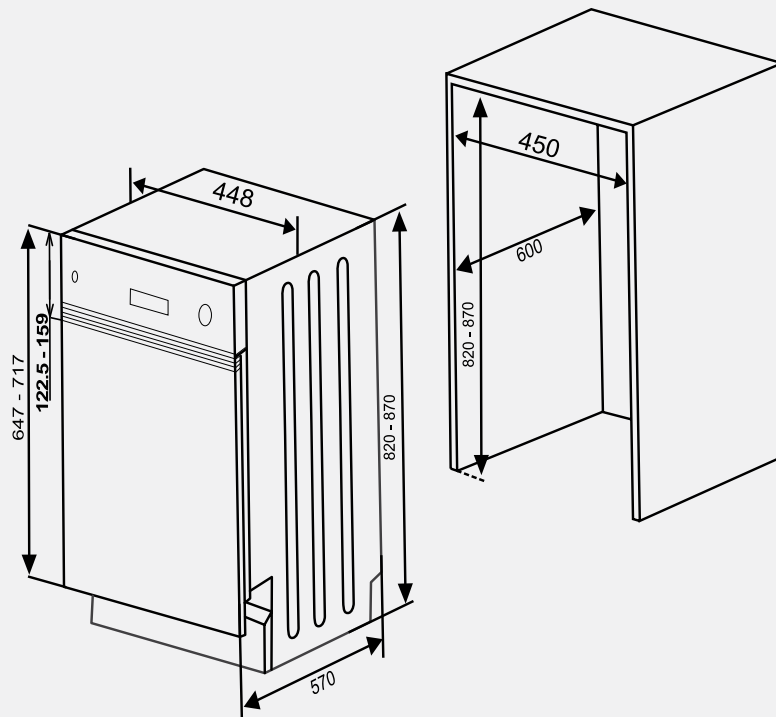

FULLY-INTEGRATED

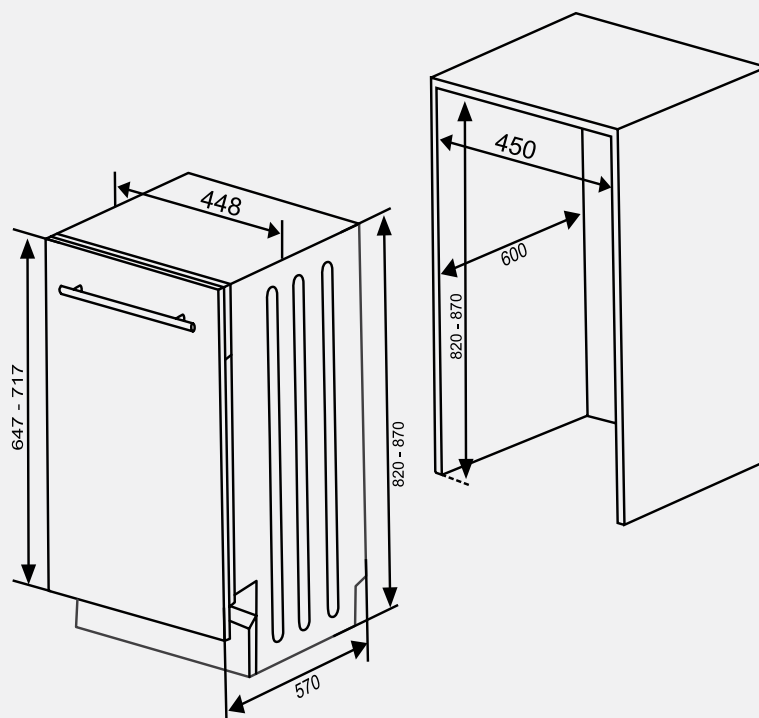



# Ovens



| Built-in Ovens    |          |          |          |
|-------------------|----------|----------|----------|
| Size              | 60LT     | 65LT     | 75LT     |
| Oven              | Electric | Electric | Electric |
| Hob Control       | Yes / No | Yes / No | Yes / No |
| Cooling System    | Yes / No | Yes / No | Yes / No |
| Self Clean (Pyro) | No       | Yes / No | Yes / No |

| Built-in Hobs |                         |                         |                         |                               |  |                                 |            |            |              |             |             |            |             |
|---------------|-------------------------|-------------------------|-------------------------|-------------------------------|--|---------------------------------|------------|------------|--------------|-------------|-------------|------------|-------------|
| Size [cm]     | 60                      |                         |                         |                               |  |                                 | 70         |            |              | 78          |             | 90         |             |
| Hob           | Gas                     | Mixed                   | Gas on Glass            | Hotplate                      | Radiant  | Induction                       | Gas        | Mixed      | Gas on Glass | Radiant     | Induction   | Gas        | Induction   |
| Control       | Side Knob<br>Front Knob | Side Knob<br>Front Knob | Side Knob<br>Front Knob | Side Knob<br>On Built-in Oven | Side Knob<br>Side Touch<br>Front Touch<br>On Built-in Oven | Front Touch<br>On Built-in Oven | Front Knob | Front Knob | Front Knob   | Front Touch | Front Touch | Front Knob | Front Touch |

| Domino Hobs |            |              |            |                           |             |
|-------------|------------|--------------|------------|---------------------------|-------------|
| Size [cm]   | 30         |              |            |                           |             |
| Hob         | Gas        | Gas on Glass | Hotplate   | Radiant                   | Induction   |
| Control     | Front Knob | Front Knob   | Front Knob | Front Knob<br>Front Touch | Front Touch |

| Freestanding Hobs |           |              |           |           |
|-------------------|-----------|--------------|-----------|-----------|
| Size [cm]         | 60        |              |           |           |
| Hob               | Gas       | Gas on Glass | Mixed     | Hotplate  |
| Control           | Side Knob | Front Knob   | Side Knob | Side Knob |

ready  
cook



PRODUCT / ACCESSORY DESCRIPTION

Ready Cook is a new TFT interface with click type knob control for built in ovens.

We're very pleased to bring the color and clarity of TFT displays to a broader range of major home appliances with Vestel's Ready Cook, along with other advanced features previously available only in more high-end oven models.

Ready Cook is designed to help users cook professional recipes easily with auto cooking functions, also allowing the users to implement their own recipes with manual cooking functions. Using a user friendly interface with the colored TFT display creates the charm of Ready Cook compared to the existing models in the high end segment.

FEATURES

- 4.3" TFT LCD Display
- Auto Cooking mode with 150 recipes
- Manuel Cooking mode
- Favorites with 10 recipe slots which can be set by end user
- Vap Clean function
- Multi language support
- Real time clock and date adjustment
- 5 levels of display brightness
- 3 levels of buzzer tone
- 10 language option
- Wi-Fi option
- A+ energy efficiency option
- A++ energy efficiency option

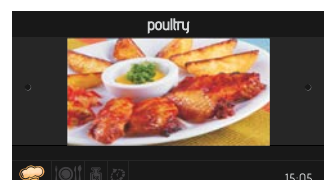
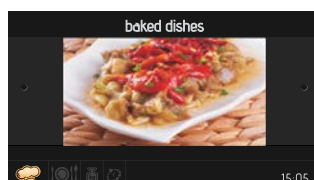
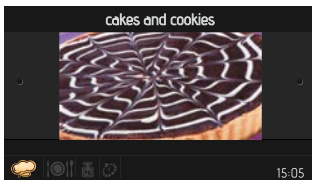
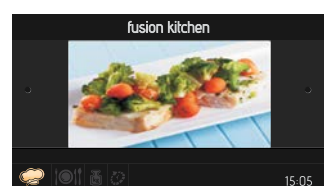
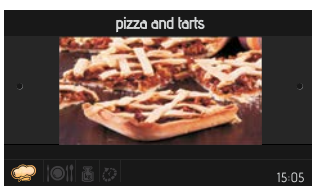
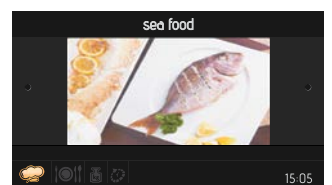
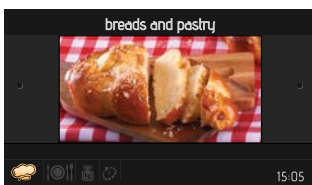
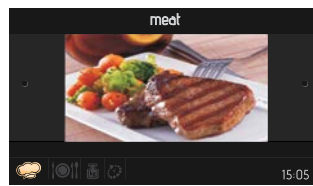
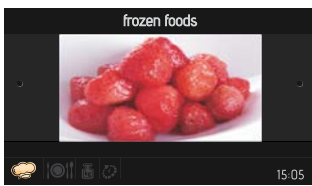
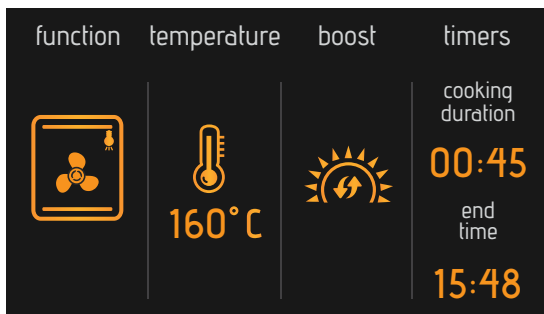
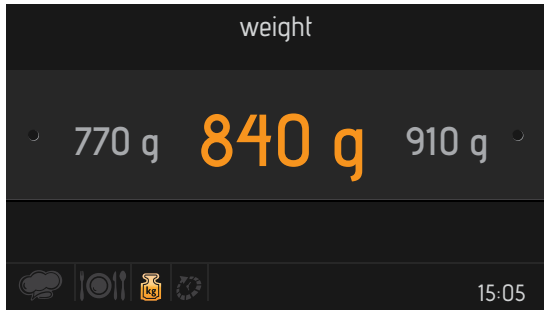



## VapClean® Function



With VapClean®, function, dried food stains inside the oven cavity is softened with vapor.

To perform VapClean®, a glass of water is poured into the small tray which will be placed at the bottom of the oven. After that, VapClean® function is activated to create vapor inside oven cavity which will soften dried food stains.

## Pyrolysis Function

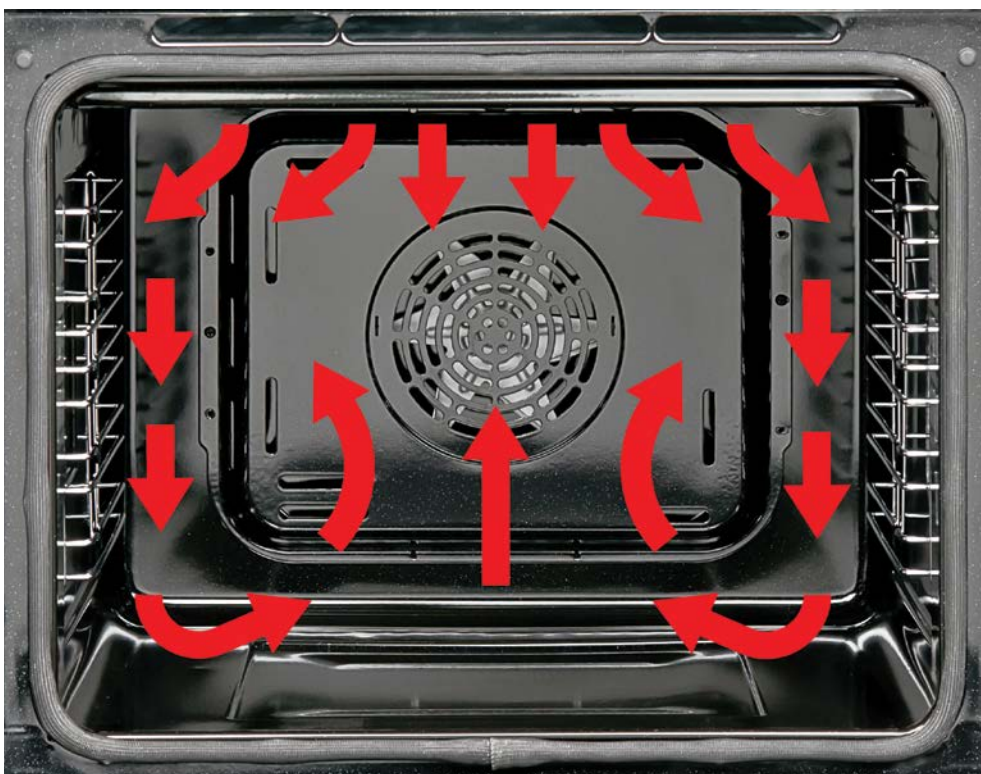

During the pyrolytic cleaning process, the oven heats up to approximately 480°C at which the temperature is kept for 1 hour while the door is locked for safety purposes.

At this temperature, residues from roasting, grilling and baking are reduced to a thin layer of ash that can simply be wiped away with a damp cloth.





TYPE 1  
Small Glass Oven Door



TYPE 2  
Large Glass Oven Door



TYPE 3  
Pyrolytic Oven Door



TYPE 4  
Full Glass Oven Door



TYPE 5  
Active Cool Oven Door



DOOR FEATURES

---



EASY TO REMOVE OVEN DOOR  
(FOR FULL INNER GLASS OVER DOOR)



EASY TO REMOVE OVEN DOOR



REMOVABLE INNER GLASS



DOOR SWITCH



SOFT CLOSE



ACTIVE COOL DOOR

I -Type Add On  
17mm (Lazer Cut)



I -Type Add On  
50mm (Cladding)



I -Type Add On  
65mm (Cladding)



U -Type Add On  
17mm (Lazer Cut)



U -Type Add On  
50mm (Cladding)



U -Type Add On 65mm (Cladding)

---

U -Type Add On  
65mm (Cladding)



O -Type Add On  
50mm (Cladding)



O -Type Add On  
85mm (Cladding)



Mono Stripe Add  
On 17mm (Lazer  
Cut)



Mono Stripe Add  
On 50mm (Lazer  
Cut)



Mono Stripe  
Add On 80mm  
(Lazer Cut)



Mono Stripe  
Add On 80mm  
(Lazer Cut)



Duo Stripe Add On (Lazer Cut)

Trio Stripe Add On (Lazer Cut)



Corner Add On (Lazer Cut)

Visio Touch Add On (Lazer Cut)



Visio Display Add On (Lazer Cut)

Smart LCD Add On (Lazer Cut)

I Type Add On  
40mm (Cladding)



U Type Add On  
17mm (Lazer Cut)



U Type Add On  
40mm (Cladding)



O Type Add On  
40mm (Cladding)



Mono Stripe Add On 40mm (Lazer Cut)

Duo Stripe Add On 40mm (Lazer Cut)





Smart Lcd Ready Cook Control Panel



Monochrome Lcd Control Panel



Full Touch Led Control Panel



Visio Display Control Panel



Visio Touch Control Panel



Visio Touch Metal Control Panel



Digital Touch Timer



Digital Touch Timer For Metal Control Panel



Digital Full Programmer



Digital Full Programmer For Metal Control Panel

CONTROL PANEL TYPES



Pyrolytic Digital Programmer



Pyrolytic Digital Programmer For Metal Control Panel

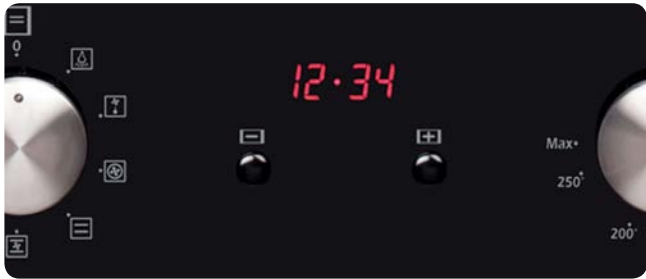

Digital Clock & Minute Minder



Digital Clock & Minute Minder For Metal Control Panel

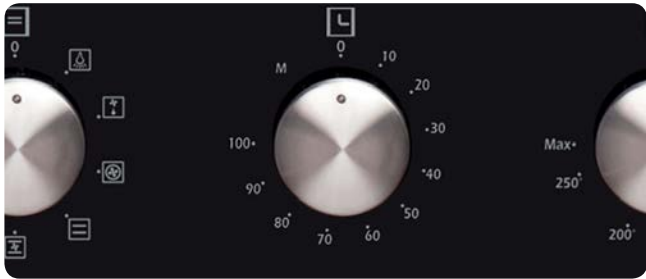

Mechanical Timer



Mechanical Timer For Metal Control Panel

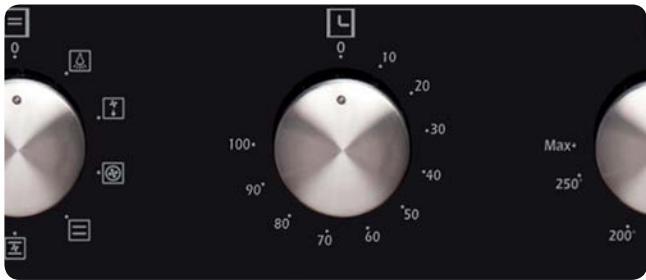

Mechanical Minute Minder



Mechanical Minute Minder For Metal Control Panel



Analog Timer



Analog Timer For Metal Control Panel



Enamel Mold Runners



Enamel Cavity With Mold Runners



Catalytic Enamel Side Panels



Catalytic Enamel Side And Rear Panels



Wire Rack In Enamel Cavity



Wire Racks In Enamel Cavity

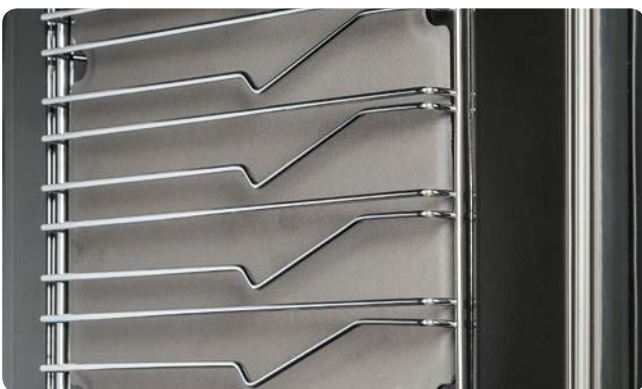

Wire Rack In Catalytic Enamel Cavity



Catalytic Enamel Panel With Side Wire Racks



TELESCOPIC SHELF TYPES

---



Single Telescopic Shelf



Double Telescopic Shelves

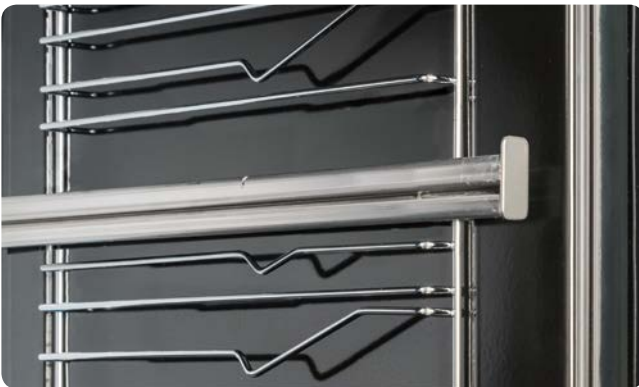

Full Extension Telescopic Shelf

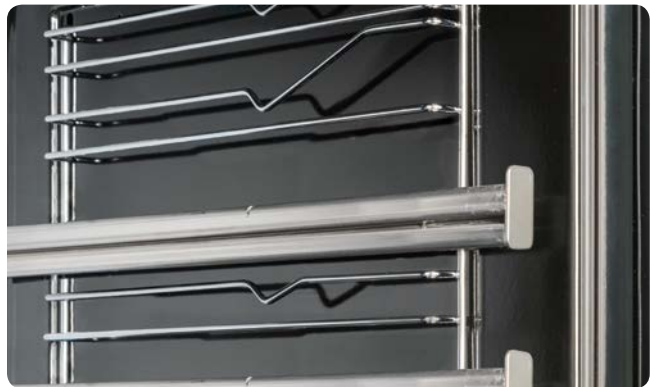

Double Full Extension Telescopic Shelves



Telescopic



Full Extension Telescopic



Telescopic Shelves Stabilizer



Telescopic Shelves Stabilizer



Oven Lamp



Side Lighting



Electric Grill



Fan With The Ring For Multifunction Ovens



Pyrolytic Enamel



Pop in Pop Out Illuminated Knobs



Serigraphy On Knob Ring



Mirror Glass



Anti Fingerprint Inox Parts



Cooling Fan



Water Tank



Child Lock



KNOB TYPES



Alfa



Antero



Big Antero



Delta Ring



Delta



Eclipse Ring



Eclipse



Gama Ring



Gama



Nord Ring



Nord



Omega



Epsilon



Rimo



Big Rimo



Big Macro



Big Macro Ring



Small Macro



Small Macro with Ring



Pop in Pop Out (PIPO)





Jannu



Jannu Ring



Spectrum



Vesta



Trio



Big Trio



Vario



Vario Ring



Zeta



Zeta Ring

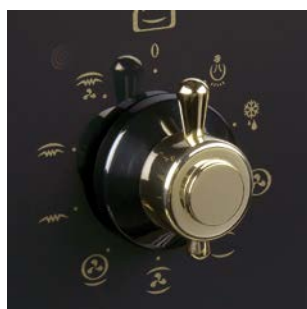

Rustic Risus

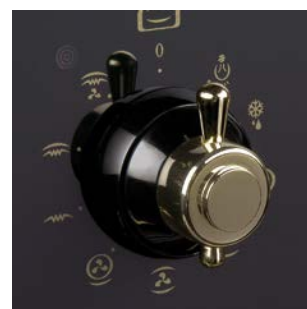

Rustic Risus with Ring



Sigma



Zenith



Feros

## HANDLE TYPES

---



3D Quadrangle



Arc Quadrangle



Arc Tube



Bow



Curved Quadrangle



Cylinder



D Profile Arc



Ellipse Arc



Flat Quadrangle



Flat Slice



Metalux



Risus



Trio



Troy



Vero



Without Cooling Fan Type





Shallow Tray



Deep Tray



80 mm Deep Tray



Grill Pan Handle Set



Chromed Wire Grid



Chromed Wire Grid For Deep Tray



Glass Tray



Round Tray And Grid Set



Pizza Stone and Shovel (Pizza Set)



Oil Filter



Meat Probe

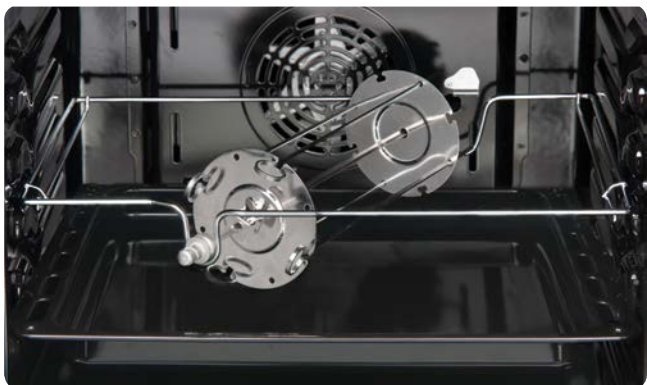

Multi Purpose Rotisserie



Turnspit Set With Grid



Turnspit Set With Metal Bracket



GENERAL SPECIFICATIONS

| 60cm BUILT-IN OVEN SPECIFICATION SHEET                              | 60cm ELECTRIC BUILT-IN OVEN     | 60cm PYROLYTIC BUILT-IN OVEN    | 60cm ELECTRIC POLYVALENTE BUILT-IN OVEN |
|---|---------------------------------|---------------------------------|---|
| <b>Available Colours</b>  |                                 |                                 |   |
| White   | Standard                        | Standard                        | Standard                                |
| Black   | Optional                        | Optional                        | Optional                                |
| Stainless Steel   | Optional                        | Optional                        | Optional                                |
| Terre de France   | Optional                        | Optional                        | Optional                                |
| Mink  | Optional                        | Optional                        | Optional                                |
| Claret Red  | Optional                        | Optional                        | Optional                                |
| Cream   | Optional                        | Optional                        | Optional                                |
| Rustic (White / Black / Cream)                                      | Optional                        | Optional                        | Optional                                |
| Silver  | Optional                        | Optional                        | Optional                                |
| <b>Control Panel</b>  |                                 |                                 |   |
| Metal   | Standard                        | Standard                        | Standard                                |
| Glass   | Optional                        | Optional                        | Optional                                |
| Various Types of Inox Add-on on Glass Control Panel                 | Optional                        | Optional                        | Optional                                |
| <b>Oven Features</b>  |                                 |                                 |   |
| Easy to Clean Enamel  | Standard                        | -                               | Standard                                |
| Catalytic Enamel Panels (Left, right and rear)                      | Optional                        | -                               | Optional                                |
| Pyrolytic Enamel  |                                 | Standard                        |   |
| Wire Side Racks   | Optional                        | Optional                        | Optional                                |
| Telescopic Rails (1 or 2 racks)                                     | Optional                        | Optional                        | Optional                                |
| Top Heating Element   | Standard                        | Standard                        | Standard                                |
| Bottom Heating Element  | Standard                        | Standard                        | Standard                                |
| Thermostat  | Standard                        | Electronic                      | Standard                                |
| Grill (Thermostatic)  | Optional                        | Optional                        | Optional                                |
| Double Grill (Thermostatic)   | Optional                        | Optional                        | Optional                                |
| Fan   | Optional                        | Optional                        | Optional                                |
| Fan with Ring Heating Element                                       | Optional                        | Optional                        | Optional                                |
| Automatic Boost Function  | available for some control unit | available for some control unit | available for some control unit         |
| Turnspit  | Optional                        | Optional                        | Optional                                |
| Thermostat Operation Indicator Light                                | Standard                        | Standard                        | Standard                                |
| Oven Operation Indicator Light                                      | Standard                        | -                               | -                                       |
| Hotplate Operation Indicator Light (in case of polyvalente oven)    | -                               | -                               | Standard                                |
| Oven Door Switch  | Optional                        | Standard                        | Optional                                |
| Oven Door lock indicator light                                      | -                               | Standard                        | -                                       |
| Minute Minder   | Optional                        | -                               | Optional                                |
| Mechanical Timer  | Optional                        | -                               | Optional                                |
| Analog Timer  | Optional                        | -                               | Optional                                |
| Digital Clock   | Optional                        | -                               | Optional                                |
| Digital Programmer  | Optional                        | Standard                        | Optional                                |
| Digital Programmer with touch interface                             |                                 |                                 |   |
| Full Touch LED Display  | Optional                        | Optional                        | Optional                                |
| Knob Control LED Display and Touch Interface (Visio Touch)          | Optional                        | Optional                        | -                                       |
| Knob Control LED Display (Visio Display)                            | Optional                        | -                               | -                                       |
| Smart LCD (Ready Cook)  | Optional                        | -                               | -                                       |
| Monochrome LCD  | Optional                        | -                               | -                                       |
| <b>Oven Door</b>  |                                 |                                 |   |
| Full outer glass and small inner glass with metal frame (4 glasses) | -                               | Standard                        | -                                       |
| Full inner glass and full glass front face (4 glasses) Oven Door    | -                               | Optional                        | -                                       |
| Full outer glass and Inner metal door (small glass) Oven Door       | Standard                        | -                               | Standard                                |
| Full outer glass and full inner glass Oven Door                     | Optional                        | -                               | Optional                                |
| Full inner glass and full glass front face Oven Door                | Optional                        | -                               | Optional                                |
| Cool touch Oven door  | Optional                        | -                               | Optional                                |
| Flotal Oven Door Glass  | Optional                        | -                               | Optional                                |
| Removable Oven Door   | Standard                        | Standard                        | Standard                                |
| Various Types of Inox Add-on on Oven Door Glass                     | Optional                        | Optional                        | Optional                                |
| Child Lock on Oven Door   | Optional                        | Standard (Electromechanic)      | Optional                                |
| <b>Accessories</b>  |                                 |                                 |   |
| Oven Light (25W)  | Optional                        | Standard                        | Optional                                |
| Oil Filter  | Optional                        | Optional                        | Optional                                |
| Meat Probe  | Optional                        | -                               | Optional                                |
| Baking Tray (Shallow Tray)  | Optional                        | 1                               | Optional                                |
| Roasting Tray (Deep Tray)   | 1                               | Optional                        | 1                                       |
| Glass Tray  | Optional                        | Optional                        | Optional                                |
| Chromed Grid with Stoper  | 1                               | 1                               | 1                                       |
| Wire grid for deep tray   | Optional                        | Optional                        | Optional                                |
| Broil Pan with Handle Set   | Optional                        | Optional                        | Optional                                |
| Multi Purpose Rorisserie  | Optional                        | Optional                        | Optional                                |
| Turnspit  | Optional                        | Optional                        | Optional                                |
| <b>Packaging</b>  |                                 |                                 |   |
| Shrink Packaging  | Optional                        | Optional                        | -                                       |
| Carton Box Packaging  | Optional                        | Optional                        | Standard                                |



## BO.110 Ready Cook

### FEATURES

- 60 cm single built-in electric oven
- 75 lt inner cavity
- Steam-assisted cooking
- Knob control slim Smart Lcd ready cook panel
- Inox knob
- Inox handle
- Wide visible area oven door
- Horizontal slim and bold laser cut inox add-on

## BO.94 Ready Cook

### FEATURES

- 60 cm single built-in electric oven
- 75 lt inner cavity
- Knob control slim Smart Lcd ready cook panel
- Inox knob
- Inox handle
- U type slim laser cut inox add-on control panel
- U type slim laser cut inox add-on oven door
- Wide visible area oven door



## BO.105 Ready Cook

### FEATURES

- 60 cm single built-in electric oven
- 75 lt inner cavity
- Slim monochrome Lcd control panel
- Black glass control panel and over door
- Black handle
- Wide visible area oven door





## BO.109 Full Touch

### FEATURES

- 60 cm single built-in electric oven
- 75 lt inner cavity
- Slim full touch led control Panel
- Amber colored diplay
- Inox handle
- Side vertical inox cladding add-on control panel
- Side vertical inox cladding add-on oven door
- Wide visible area oven door

## BO.106 Visio Touch

### FEATURES

- 60 cm single built-in electric oven
- 75 lt inner cavity
- Visio Touch Metal Control Panel
- Slim inox control panel
- Amber colored diplay
- Inox pop-in pop-out knobs
- Inox handle
- Wide visible area oven door
- Horizontal bold laser cut inox add-on oven door



## BO.96 Visio Touch

### FEATURES

- 60 cm single built-in electric oven
- 75 lt inner cavity
- Visio Touch Control Panel
- Amber colored diplay
- Inox pop-in pop-out knobs
- Inox handle
- White optical glass slim control panel
- White optical glass oven door
- Wide visible area oven door



## BO.98

### FEATURES

- 60 cm single built-in electric oven
- 75 lt inner cavity
- Inox slim control panel
- Inox knob
- Inox handle
- Side vertical inox cladding add-on oven door
- Digital Full Programmer
- Wide visible area oven door

## BO.97

### FEATURES

- 60 cm single built-in electric oven
- 75 lt inner cavity
- White knobs
- White handle
- White optical glass slim control panel
- White optical glass oven door
- Digital Touch Timer
- Wide visible area oven door



## BO.99

### FEATURES

- 60 cm single built-in electric oven
- 75 lt inner cavity
- Inox pop-in pop-out knobs
- Inox handle
- O type inox cladding add-on control panel
- O type inox cladding add-on oven door
- Mechanical timer
- Wide visible area oven door





## BO.67 Pyro

### FEATURES

- 60 cm single built-in electric oven
- Pyrolytic Function
- Full Touch Led control panel
- Inox handle
- Horizontal slim laser cut inox add-on control panel
- Horizontal bold laser cut inox add-on oven door
- Amber colored display

## BO.85 Pyro

### FEATURES

- 60 cm single built-in electric oven
- Pyrolytic Function
- Visio Touch Metal Control Panel
- Inox pop-in pop-out knobs
- Inox handle
- Side vertical inox cladding add-on oven door
- Amber colored display



## BO.84 Pyro

### FEATURES

- 60 cm single built-in electric oven
- Pyrolytic Function
- Visio Touch Control Panel
- Inox pop-in pop-out knobs
- Inox handle
- Horizontal bold laser cut inox add-on oven door
- Amber colored display





## BO.65 Pyro

### FEATURES

- 60 cm single built-in electric oven
- Pyrolytic Function
- Pyrolytic Digital Programmer
- Inox knobs
- Inox handle
- Side vertical inox cladding add-on oven door
- U type cladding inox add-on control panel

## BO.89 Pyro

### FEATURES

- 60 cm single built-in electric oven
- Pyrolytic Function
- Pyrolytic Digital Programmer
- Inox pop-in pop-out knobs
- Inox handle
- Horizontal laser cut inox add-on oven door



## BO.90 Pyro

### FEATURES

- 60 cm single built-in electric oven
- Pyrolytic Function
- Pyrolytic Digital Programmer
- White glass control panel
- White glass oven door





## BO.86 Ready Cook

### FEATURES

- 60 cm single built-in electric oven
- Knob control Smart Lcd ready cook panel
- Inox knob
- Inox handle
- U type cladding inox add-on control panel
- U type cladding inox add-on oven door
- Anti-fingerprint inox part

## BO.87 Ready Cook

### FEATURES

- 60 cm single built-in electric oven
- Knob control Smart Lcd ready cook panel
- Inox knob
- Inox handle
- Mirror glass control panel and over door
- Side vertical cladding inox add-on control panel
- Side vertical cladding inox add-on oven door



## BO.88 Ready Cook

### FEATURES

- 60 cm single built-in electric oven
- Steam-assisted cooking
- Knob control Smart Lcd ready cook panel
- Inox knob
- Inox handle
- Black glass control panel and over door





## BO.66 Full Touch

### FEATURES

- 60 cm single built-in electric oven
- Full Touch Led control panel
- Inox handle
- Horizontal slim laser cut inox add-on control panel
- Horizontal bold laser cut inox add-on oven door
- Amber colored display

## BO.70 Full Touch

### FEATURES

- 60 cm single built-in electric oven
- Full Touch Led control panel
- Inox handle
- Side vertical cladding inox add-on control panel
- Side vertical cladding inox add-on oven door
- Amber colored display
- Wide visible area oven door



## BO.77 Visio Touch

### FEATURES

- 60 cm single built-in electric oven
- Visio Touch Control Panel
- Amber colored illuminated Inox pop-in pop-out knobs
- Inox handle
- Horizontal slim laser cut inox add-on control panel
- Horizontal bold laser cut inox add-on oven door





## BO.75 Full Touch

### FEATURES

- 60 cm single built-in electric oven
- Full Touch Led control panel
- Inox handle
- Horizontal bold laser cut inox add-on oven door
- Amber colored display

## BO.78 Visio Touch

### FEATURES

- 60 cm single built-in electric oven
- Visio Touch Control Panel
- Inox pop-in pop-out knobs
- Inox handle
- White optical glass control panel and oven door
- U type cladding inox add-on control panel
- U type cladding inox add-on oven door
- Amber colored display
- Wide visible area oven door



## BO.83 Visio Touch

### FEATURES

- 60 cm single built-in electric oven
- Visio Touch Control Panel
- Amber colored display
- Inox pop-in pop-out knobs
- Inox handle
- Laser-cut visio inox cladding on control panel
- Horizontal slim and horizontal add-on
- Laser-cut inox cladding on oven door



## BO.81 Visio Display

### FEATURES

- 60 cm single built-in electric oven
- Visio Display Control Panel
- Inox pop-in pop-out knobs
- Inox handle
- Visio lazer cut inox add-on control panel
- U type lazer cut inox add-on oven door
- Amber colored display

## BO.92 Visio Display

### FEATURES

- 60 cm single built-in electric oven
- Visio Display Control Panel
- Black pop-in pop-out knobs
- Black handle
- Black glass control panel and oven door
- Amber colored display



## BO.93 Visio Display

### FEATURES

- 60 cm single built-in electric oven
- Visio Display Control Panel
- Inox pop-in pop-out knobs
- Inox handle
- White optical glass control panel and oven door
- Amber colored display







## BO.100

### FEATURES

- 60 cm single built-in electric oven
- Digital touch timer
- Inox knobs
- Inox handle
- Side vertical laser-cut inox add-on control panel
- Side vertical laser-cut inox add-on oven door
- Wide visible area oven door

## BO.74

### FEATURES

- 60 cm single built-in electric oven
- Amber colored illuminated pop-in pop-out knobs
- Inox handle
- U type slim laser cut inox add-on control panel
- U type slim laser cut inox add-on oven door
- Digital full programmer



## BO.05

### FEATURES

- 60 cm single built-in electric oven
- Inox knobs
- Inox handle
- Black glass control panel and oven door
- U type cladding inox add-on control panel
- U type cladding inox add-on oven door
- Digital full programmer



## BO.60

### FEATURES

- 60 cm single built-in electric oven
- Inox knobs
- Inox handle
- Black glass control panel and oven door
- O type special inox effect serigraphy on control panel
- O type special inox effect serigraphy on oven door
- Digital full programmer

## BO.09

### FEATURES

- 60 cm single built-in electric oven
- White knobs
- White handle
- Black glass control panel and oven door
- Side vertical white serigraphy on control panel
- Side vertical white serigraphy on oven door
- Mechanical timer



## BO.11

### FEATURES

- 60 cm single built-in electric oven
- Silver knobs
- Inox handle
- Silver optical glass control panel and oven door
- Side vertical cladding inox add-on control panel
- Side vertical cladding inox add-on oven door
- Digital full programmer





## BO.42

### FEATURES

- 60 cm single built-in electric oven
- Inox knobs
- Inox handle
- Inox glass control panel and oven door
- Side vertical cladding inox add-on control panel
- U type cladding inox add-on oven door
- Digital full programmer

## BO.13

### FEATURES

- 60 cm single built-in electric oven
- Inox pop-in pop-out knobs
- Inox handle
- White optical glass control panel
- White optical glass oven door
- Side vertical cladding inox add-on control panel
- Side vertical cladding inox add-on oven door
- Digital full programmer



## BO.14

### FEATURES

- 60 cm single built-in electric oven
- Inox knobs
- Inox handle
- O type cladding inox add-on oven door
- Digital touch timer



## BO.39

### FEATURES

- 60 cm single built-in electric oven
- Inox knob
- Inox handle
- Mirror glass oven door
- Mechanical timer

## BO.82

### FEATURES

- 60 cm single built-in electric oven
- Inox pop-in pop-out knobs
- Inox handle
- Corner type laser cut inox add-on control panel
- Horizontal bold laser cut inox add-on oven door
- Digital full programmer



## BO.15

### FEATURES

- 60 cm single built-in electric oven
- Inox knobs
- Inox handle
- Inox control panel
- O type cladding inox add-on oven door
- Mechanical timer



## BO.17

### FEATURES

- 60 cm single built-in electric oven
- Inox knobs
- Inox handle
- Inox control panel
- Horizontal bold laser cut inox add-on oven door
- Mechanical timer

## BO.18

### FEATURES

- 60 cm single built-in electric oven
- Inox knobs
- Inox handle
- Inox control panel
- Black glass oven door



## BO.36

### FEATURES

- 60 cm single built-in electric oven without cooling fan
- Inox knobs
- Inox handle (without cooling fan type)
- Inox control panel
- Black glass oven door
- Digital clock (not programmer)







## BO.73

### FEATURES

- 60 cm single built-in electric oven
- Black knobs
- Black handle
- Special black hairline cladding add-on control panel
- Special black hairline cladding add-on oven door
- Digital full programmer

## BO.22

### FEATURES

- 60 cm single built-in electric oven
- Black knobs
- Black handle
- Silver glass control panel
- Silver glass oven door
- Digital full programmer
- Front face serigraphy application



## BO.38

### FEATURES

- 60 cm single built-in electric oven
- Inox knobs
- Inox handle
- Inox glass control panel
- Inox glass oven door
- Digital full programmer
- Front face serigraphy application





## BO.24

### FEATURES

- 60 cm single built-in electric oven
- Inox knobs
- Inox handle
- Black glass control panel
- Black glass oven door
- Digital Clock & Minute Minder (not programmer)

## BO.37

### FEATURES

- 60 cm single built-in electric oven
- Black knobs
- Black handle
- Black painted metal control panel
- Black glass oven door
- Digital Clock & Minute Minder (not programmer)



## BO.25

### FEATURES

- 60 cm single built-in electric oven
- Black knobs
- Black handle
- TDF optical glass control panel
- TDF optical glass oven door
- Mechanical timer



## BO.26

### FEATURES

- 60 cm single built-in electric oven
- White knobs
- White handle
- White glass control panel
- White glass oven door
- Digital Clock & Minute Minder (not programmer)
- Front face serigraphy application

## BO.29

### FEATURES

- 60 cm single built-in electric oven
- White knobs
- White handle
- White painted metal control panel
- White glass oven door
- Mechanical timer



## BO.30

### FEATURES

- 60 cm single built-in electric oven
- White knobs
- White handle
- White painted metal control panel
- White glass oven door





## BO.107 Rustic

### FEATURES

- 60 cm single built-in electric oven
- Rustic style Risus knobs
- Rustic style Risus handle
- Black Colored Rustic Metal Art Design Control Panel and Oven Door
- Analog timer

## BO.108 Rustic

### FEATURES

- 60 cm single built-in electric oven
- Rustic style Risus knobs
- Rustic style Risus handle
- Sand Colored Rustic Metal Art Design Control Panel and Oven Door
- Analog timer



## BO.48 Rustic

### FEATURES

- 60 cm single built-in electric oven
- Rustic style Risus knobs
- Rustic style Risus handle
- Type-C rustic design artwork
- Black glass control panel and oven door
- Mechanical timer





## BO.50 Rustic

### FEATURES

- 60 cm single built-in electric oven
- Rustic style Risus knobs
- Rustic style Risus handle
- Type-C rustic design artwork
- Sand color optical glass control panel
- Sand color optical glass oven door
- Mechanical timer

## BO.47 Rustic

### FEATURES

- 60 cm single built-in electric oven
- Rustic style Risus knobs
- Rustic style Risus handle
- Type-A rustic design artwork
- Green optical glass control panel
- Green optical glass oven door
- Analog timer

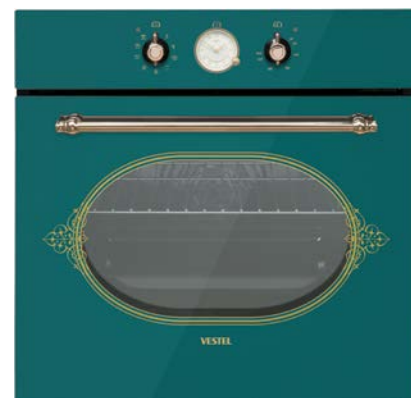

## BO.46 Rustic

### FEATURES

- 60 cm single built-in electric oven
- Rustic style Risus knobs
- Rustic style Risus handle
- Type-B rustic design artwork
- White optical glass control panel
- White optical glass oven door







## BO.101 Combi

### FEATURES

- 60 cm combi electric oven
- 75 lt inner cavity
- Inox pop-in pop-out knobs
- Inox handle
- Black glass slim control panel
- Digital touch timer
- Wide visible area oven door

## BO.111 Combi

### FEATURES

- 60 cm combi electric oven
- 75 lt inner cavity
- Inox knobs
- Inox handle
- Inox slim control panel
- O type inox cladding add-on oven door
- Digital touch timer
- Wide visible area oven door



## BO.102 Combi

### FEATURES

- 60 cm combi electric oven
- 75 l inner cavity
- Inox pop-in pop-out knobs
- Inox handle
- Inox slim control panel
- Digital full programmer
- Wide visible area oven door



## BO.103 Combi

### FEATURES

- 60 cm combi electric oven
- 75 lt inner cavity
- Inox pop-in pop-out knobs
- Inox handle
- Inox slim control panel
- U type inox cladding add-on oven door
- Mechanical timer
- Wide visible area oven door

## BO.91 Visio Touch Combi

### FEATURES

- 60 cm combi electric oven
- Visio Touch Control Panel
- Black glass control panel
- Inox pop-in pop-out knobs
- Inox handle
- Horizontal bold laser-cut inox cladding on oven door



## BO.01 Combi

### FEATURES

- 60 cm combi electric oven
- Inox pop-in pop-out knobs
- Inox handle
- Black glass control panel and oven door
- O type inox cladding add-on control panel
- U type inox cladding add-on oven door
- Digital full programmer





## BO.104 Combi

### FEATURES

- 60 cm combi electric oven
- Inox knobs
- Inox handle
- Black glass control panel and oven door
- Horizontal slim laser cut inox add-on control panel
- Horizontal laser cut inox add-on oven door
- Digital touch timer

## BO.02 Combi

### FEATURES

- 60 cm combi electric oven
- Inox pop-in pop-out knobs
- Inox handle
- Inox control panel
- Side vertical cladding inox add-on oven door
- Large display digital programmer



## BO.58 Combi

### FEATURES

- 60 cm combi electric oven
- White metal control panel
- White knobs
- White handle
- Black glass oven door
- O type white metal cladding add-on oven door
- Mechanical timer





## BO.61 Rustic Combi

### FEATURES

- 60 cm combi electric oven
- Rustic style Risus knobs
- Rustic style Risus handle
- Type-C rustic design artwork
- Black glass control panel and oven door

## BO.69 Combi

### FEATURES

- 60 cm combi electric oven
- Inox pop-in pop-out knobs
- Inox handle
- White optical glass control panel and oven door
- Side vertical cladding inox add-on control panel
- Side vertical cladding inox add-on oven door
- Digital full programmer



## BO.34 Combi

### FEATURES

- 60 cm combi electric oven without cooling fan
- White knobs
- White handle (without cooling fan type)
- White metal control panel
- Black glass oven door
- U type white serigraphy on oven door



# Hobs



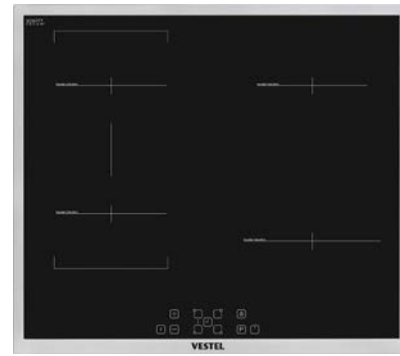
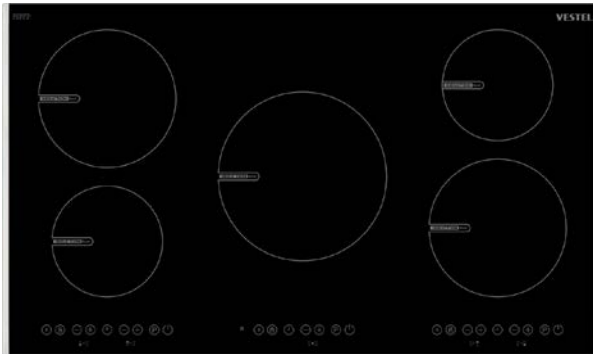

Vestel Induction Hobs

**VESTEL** 100% Vestel Induction Technology

**Easy Touch** Easy to Use with touch control unit

**High EFFICIENCY** High Efficiency with low energy consumption

**SAFETY** Thermal cut off system  
Safe usage with pan detector  
The glass surface is not directly heated thanks to the induction technology

**Power BOOST** Quick heating with PowerBoost

**Boiling** Fixes the cooking zone in boiling temperature (100°C)

**Frying** Fixes the cooking zone in frying temperature (160°C)

**KEEP Warm** Keeps the cooking zone in 50°C

**Chocolate MELTING** Special function for chocolate melting (40°C)

**Bridge Zone** This function locks two zones to act as a single zone for using large utensils.

**TIMER** Cooking duration control with Timer

**smart pause** Will pause all the cooking in all zones and restart it from the same power levels when pressed again. Keeps the paused zones warm.

**KEY LOCK** Key lock function is for to block and to set the appliance in a safe mode during operation and cleaning.

**Child Lock** Safe usage with Child Lock

**AutoOFF** The hob will shut off automatically if left idle for a long time. (1,5 to 6 hours depending on the power level)

**EasyClean** Easy to clean thanks to special glass surface





Slim Design (for induction hobs)

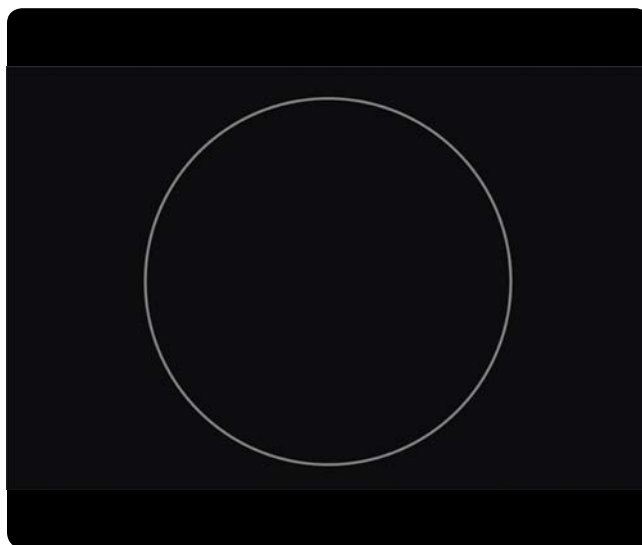

Slim Design for Vitroceramic Hobs



Line Design (for induction hobs)

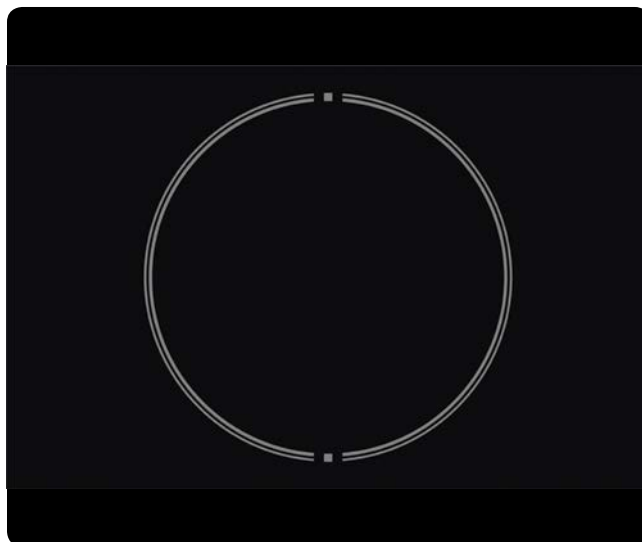

Point Design for Vitroceramic Hobs



Plus Design (for induction hobs)

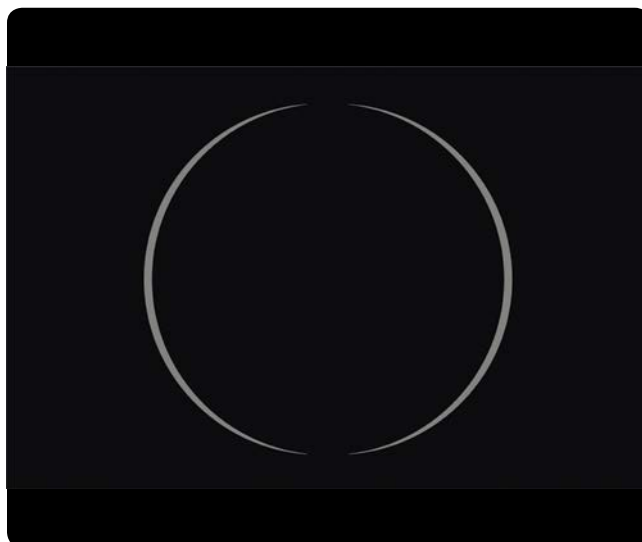

Arc Design for Vitroceramic Hobs

Touch Control Panel for 90cm induction hobs



Slider Touch Control Panel for Slim Design (induction hobs Series II)

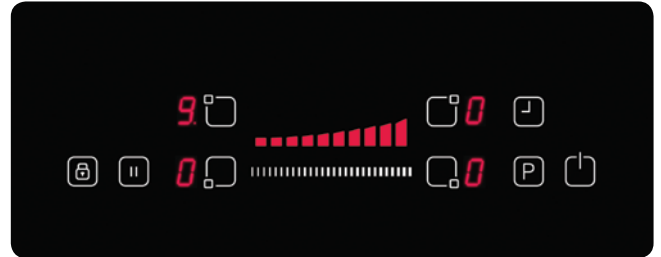

Slider Touch Control Panel for Plus and Line Design (induction hobs Series II)

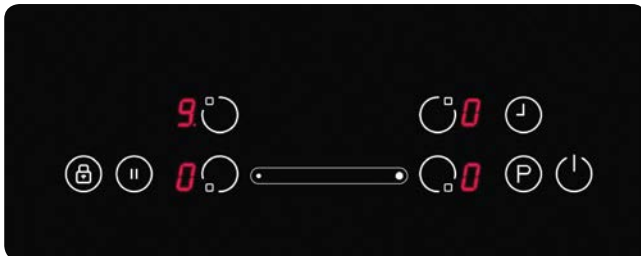

Slider Touch Control Panel for Slim Design (induction hobs Series I)

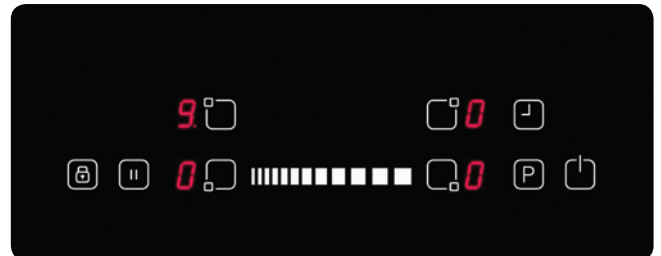

Slider Touch Control Panel for Plus and Line Design (induction hobs Series I)



Touch Control Panel for induction hobs

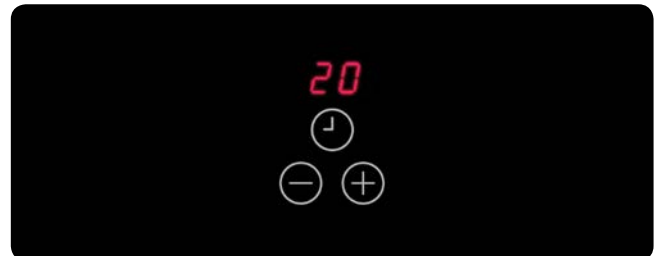

Touch Control Panel for induction poly hobs

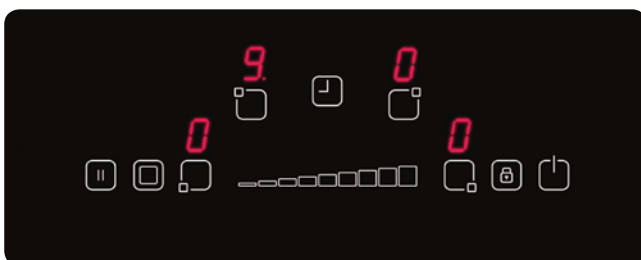

Slider Touch Control Panel (for vitro hobs)

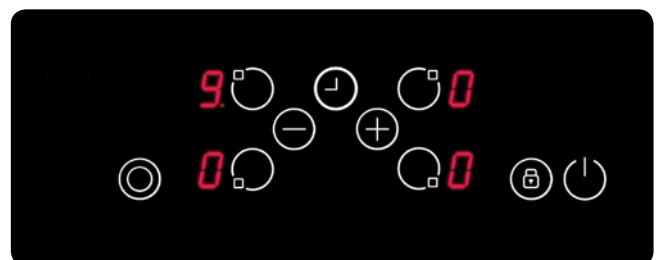

Touch Control Panel for vitroceramic hobs



Touch Control Panel for domino induction hobs

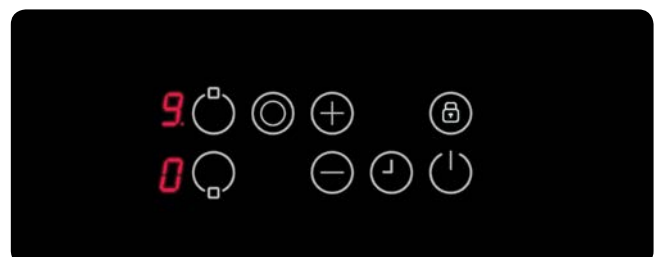

Touch Control Panel for domino vitro hobs



180 mm Dual Zone For Vitroceramic Hobs

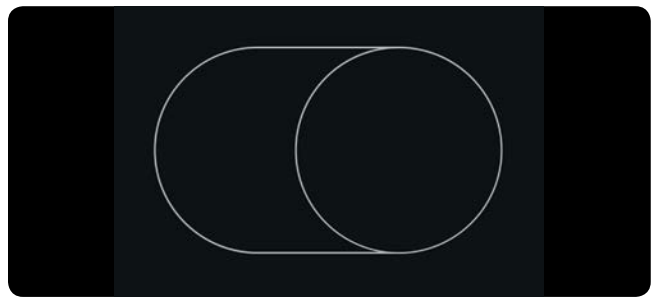

145 mm Oval Zone For Vitroceramic Hobs

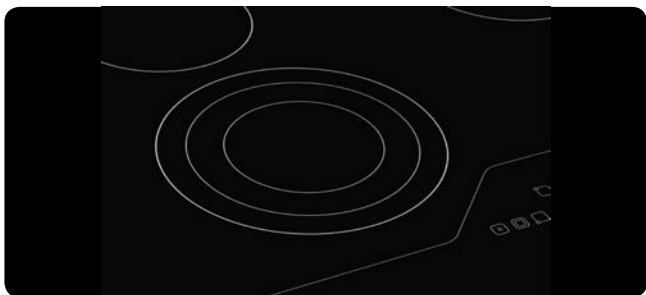

210 mm Triple Zone For Vitroceramic Hobs

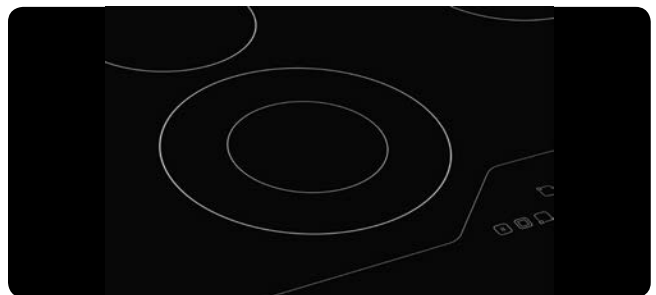

210 mm Zone Dual Zone For Vitroceramic Hobs

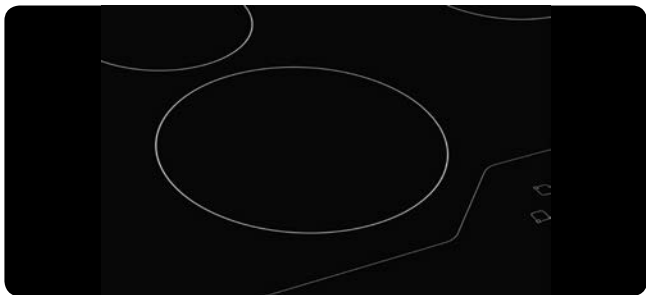

210 mm Zone For Vitroceramic Hobs



Bridge Zone

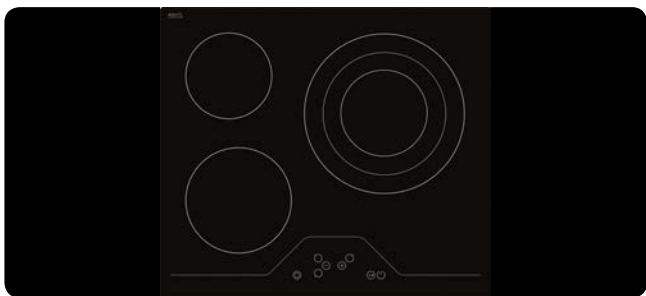

290 mm Triple Zone For Vitroceramic Hobs

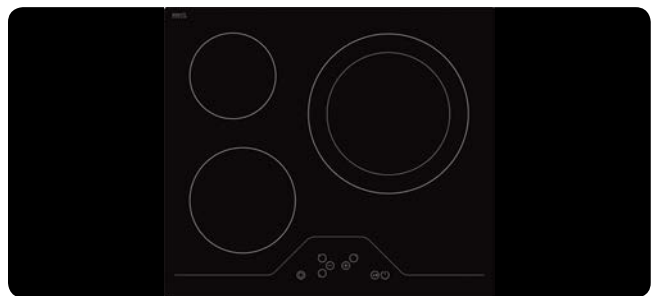

290 mm Dual Zone For Vitroceramic Hobs

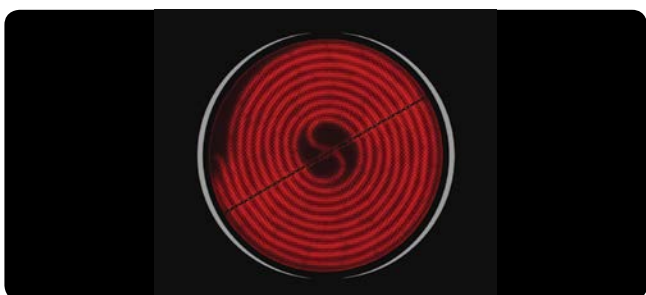

Highlight Heating Element

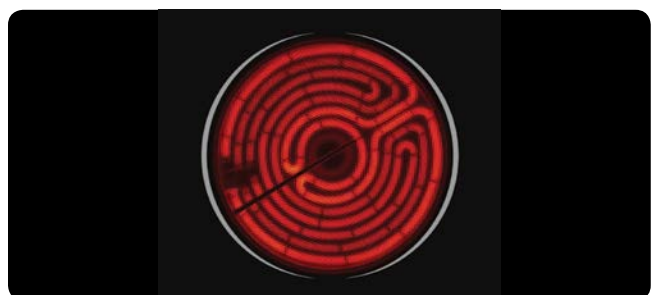

Radiant Heating Element



Hot Surface Indicator Light For Vitroceramic Hobs

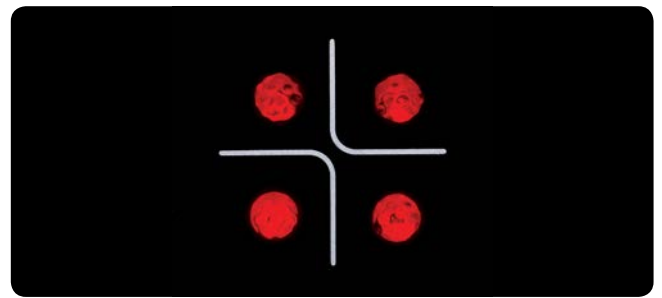

Hot Surface Indicators For Vitroceramic Hobs



Bevelled Edges For Vitroceramic Hobs



Inox Frame



Full Inox Frame



Two Sides Inox Frame

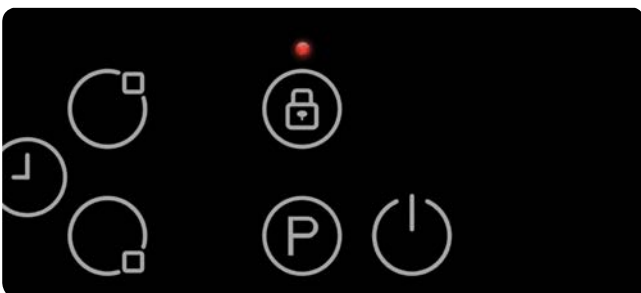

Key Lock For Induciton Hobs



Vitroceramic Glass Cleaning Spatula



Enamel Pan Supports (Gas On Glass Hobs)



Cast Iron Pan Supports (Gas On Glass Hobs)



Mat Enamel Pan Supports (Gas On Glass Hobs)



Profile Type Pan Supports (Gas On Glass Hobs)



Plus X Cast Iron (Gas On Glass)



Plusx Cat Iron (Gas On Glass)



Deluxe Pan Supports (Gas On Glass)



Line Pan Supports (Gas On Glass)





S-Type



V-Type



D-Type



O-Type



K-Type



W-Type



S-Type



E-Type



K-Type





Enamel Pan Supports



Mat Enamel Pan Supports



Cast Iron Pan Supports



Enamel Burner Pan And Enamel Pan Support For Gas On Glass Hobs



Mat Enamel Burner Pan And Cast Iron Pan Support For Gas On Glass Hobs



Inox Burner Pan And Mat Enamel Pan Supports For Gas On Glass Hobs



Ignition For Gas Burners



Flame Failure Device For Gas Burners



Enamel Flat Burner Caps



Enamel 3D Burner Caps



Cast Iron Burner Caps



Mat Enamel Burner Caps



Enamel Wok Adapter



Enamel Wok Adapter (Square)



Cast Iron Wok Adapter



Cast Iron Wok Adaptor for High Efficiency Wok Burner (for 90cm Securit Hobs)"





Rapid Solid Hotplate



Wok Burner



Button Ignition For Gas Hobs



Mechanical Timer For Domino Hobs



Cast Iron Coffee Support



High Efficiency Wok Burner  
(for 90cm Securit Hobs)



Enamel Coffee Support

| BUILT-IN / TABLE-TOP HOB SPECIFICATION SHEET   |    | BI Gas/Combined Hobs     |                          |                          |                          |                          |                 |                          |                          |
|--|----|--------------------------|--------------------------|--------------------------|--------------------------|--------------------------|-----------------|--------------------------|--------------------------|
|  |    | 60 CM                    | 60 CM                    | 60 CM                    | 60 CM                    | 60 CM                    | 60 CM           | 70 CM                    | 70 CM                    |
|  |    | Flat / Surface           | Extenda                  | Classic                  | Model I                  | PlusX                    | Division        | Model I                  | PlusX                    |
| Available Colours  |    |                          |                          |                          |                          |                          |                 |                          |                          |
| White  |    | Standard                 | Standard                 | Standard                 | Standard                 | Standard                 | -               | Standard                 | Standard                 |
| Brown  |    | Optional                 | Optional                 | Optional                 | Optional                 | Optional                 | -               | Optional                 | Optional                 |
| Terre de France  |    | Optional                 | Optional                 | Optional                 | Optional                 | Optional                 | -               | Optional                 | Optional                 |
| Black  |    | Optional                 | Optional                 | Optional                 | Optional                 | Optional                 | -               | Optional                 | Optional                 |
| Dark Green   |    | Optional                 | Optional                 | Optional                 | Optional                 | Optional                 | -               | Optional                 | Optional                 |
| Stainless Steel  |    | Optional                 | Optional                 | Optional                 | Optional                 | Optional                 | Standard        | Optional                 | Optional                 |
| Product Dimensions   |    |                          |                          |                          |                          |                          |                 |                          |                          |
| Height (max.,varies from model to model)   | mm | 40                       | 40                       | 40                       | 39,5                     | 42                       | 42              | 39,5                     | 42                       |
| Width  | mm | 580                      | 580                      | 580                      | 590                      | 580                      | 580             | 680                      | 700                      |
| Depth (max., do not include gas connection detail)   | mm | 510                      | 510                      | 510                      | 515                      | 515                      | 510             | 515                      | 515                      |
| Cut-out Dimensions   |    |                          |                          |                          |                          |                          |                 |                          |                          |
| Width  | mm | 560                      | 560                      | 560                      | 560                      | 560                      | 560             | 560                      | 560                      |
| Depth  | mm | 490                      | 490                      | 490                      | 490                      | 490                      | 490             | 490                      | 490                      |
| Hob Features   |    |                          |                          |                          |                          |                          |                 |                          |                          |
| Hob  |    | Enamel / Stainless Steel | Enamel / Stainless Steel | Enamel / Stainless Steel | Enamel / Stainless Steel | Enamel / Stainless Steel | Stainless Steel | Enamel / Stainless Steel | Enamel / Stainless Steel |
| Rapid Gas Burner Ø10cm   | W  | 3000                     | 3000                     | 3000                     | 3000                     | 3000                     | 3000            | 3000                     | 3000                     |
| Semi-rapid Gas Burner Ø7.5cm   | W  | 1750                     | 1750                     | 1750                     | 1750                     | 1750                     | 1750            | 1750                     | 1750                     |
| Auxiliary Gas Burner Ø5.5cm  | W  | 1000                     | 1000                     | 1000                     | 1000                     | 1000                     | 1000            | 1000                     | 1000                     |
| Wok (Triple Flame) Gas Burner Mono Ø14cm   | W  | 3800                     | 3800                     | 3600                     | 3600                     | -                        | -               | 3600                     | 3600                     |
| Wok (Triple Flame) Gas Burner Dual Ø14cm   | W  | -                        | -                        | -                        | -                        | -                        | -               | -                        | -                        |
| Wok (Triple Flame) Gas Burner Ø11cm  | W  | -                        | -                        | -                        | -                        | 3200                     | -               | -                        | -                        |
| Ø 145 mm Hotplate  | W  | -                        | -                        | 1000                     | 1000                     | 1000                     | -               | 1000                     | 1000                     |
| Ø 180 mm Hotplate  | W  | 1500                     | 1500                     | -                        | -                        | -                        | -               | -                        | -                        |
| Ø 145 mm Rapid Hotplate  | W  | -                        | -                        | -                        | -                        | -                        | -               | -                        | -                        |
| Ø 180 mm Rapid Hotplate  | W  | -                        | -                        | -                        | -                        | -                        | -               | -                        | -                        |
| Ø145 mm Highlite Element   | W  | -                        | -                        | -                        | -                        | -                        | -               | -                        | -                        |
| Ø180 mm Highlite Element   | W  | -                        | -                        | -                        | -                        | -                        | -               | -                        | -                        |
| Ø210 mm Highlite Element   | W  | -                        | -                        | -                        | -                        | -                        | -               | -                        | -                        |
| Ø180 mm Dual Highlite Element  | W  | -                        | -                        | -                        | -                        | -                        | -               | -                        | -                        |
| Ø145 mm Oval Highlite Element  | W  | -                        | -                        | -                        | -                        | -                        | -               | -                        | -                        |
| Ø210 mm Dual Highlite Element  | W  | -                        | -                        | -                        | -                        | -                        | -               | -                        | -                        |
| Ø210 mm Triple Highlite Element  | W  | -                        | -                        | -                        | -                        | -                        | -               | -                        | -                        |
| Ø290 mm Dual/Triple Highlite Element   | W  | -                        | -                        | -                        | -                        | -                        | -               | -                        | -                        |
| Ø 160 mm Induction Zone(Serie 1 and Serie 2)   | W  | -                        | -                        | -                        | -                        | -                        | -               | -                        | -                        |
| Ø 200 mm Induction Zone(Serie 1)   | W  | -                        | -                        | -                        | -                        | -                        | -               | -                        | -                        |
| Ø 210 mm Induction Zone(Serie 2)   | W  | -                        | -                        | -                        | -                        | -                        | -               | -                        | -                        |
| Ø 250 mm Induction Zone(Serie 1)   | W  | -                        | -                        | -                        | -                        | -                        | -               | -                        | -                        |
| Ø 290 mm Induction Zone(Serie 2)   | W  | -                        | -                        | -                        | -                        | -                        | -               | -                        | -                        |
| Boost Function   |    | -                        | -                        | -                        | -                        | -                        | -               | -                        | -                        |
| Pot Dedection  |    | -                        | -                        | -                        | -                        | -                        | -               | -                        | -                        |
| Automatic Heatup   |    | -                        | -                        | -                        | -                        | -                        | -               | -                        | -                        |
| Timer function for vitro ceramic hobs (If touch control with some hob configuration selected)    |    | -                        | -                        | -                        | -                        | -                        | -               | -                        | -                        |
| Mode function for induction ceramic hobs (If touch control with some hob configuration selected) |    | -                        | -                        | -                        | -                        | -                        | -               | -                        | -                        |
| Bridge zone for induction ceramic hobs (If touch control with some hob configuration selected)   |    | -                        | -                        | -                        | -                        | -                        | -               | -                        | -                        |
| Child Lock for vitro ceramic hobs (If touch control selected)                                    |    | -                        | -                        | -                        | -                        | -                        | -               | -                        | -                        |
| Mechanical Child Lock (Main Switch)  |    | -                        | -                        | -                        | -                        | -                        | -               | -                        | -                        |
| Hot Surface Indicator Light  |    | -                        | -                        | -                        | -                        | -                        | -               | -                        | -                        |
| Hotplate Operation Indicator Light   |    | Standard                 | Standard                 | Standard                 | Standard                 | Standard                 | -               | Standard                 | Standard                 |
| Side Knob Control  |    | Standard                 | Standard                 | Standard                 | -                        | -                        | -               | -                        | -                        |
| Side Touch Control   |    | -                        | -                        | -                        | -                        | -                        | -               | -                        | -                        |
| Front Knob Control   |    | -                        | -                        | -                        | Standard                 | Standard                 | -               | Standard                 | Standard                 |
| Double Side Front Control  |    | -                        | -                        | -                        | -                        | -                        | Standard        | -                        | -                        |
| Front Triangular Touch Control   |    | -                        | -                        | -                        | -                        | -                        | -               | -                        | -                        |
| Front Slider Touch Control   |    | -                        | -                        | -                        | -                        | -                        | -               | -                        | -                        |
| Front Touch Control  |    | -                        | -                        | -                        | -                        | -                        | -               | -                        | -                        |
| Bevelled Edges   |    | -                        | -                        | -                        | -                        | -                        | -               | -                        | -                        |
| Logo   |    | Standard                 | Standard                 | Standard                 | Standard                 | Standard                 | Standard        | Standard                 | Standard                 |
| Special Decoration on Glass  |    | -                        | -                        | -                        | -                        | -                        | -               | -                        | -                        |
| Vitroceraic Glass Artwork  |    | -                        | -                        | -                        | -                        | -                        | -               | -                        | -                        |
| Inox Frame   |    | -                        | -                        | -                        | -                        | -                        | -               | -                        | -                        |
| Stainless Steel Burner Pan   |    | -                        | -                        | -                        | -                        | -                        | -               | -                        | -                        |
| Table Top Installation (not built-in)  |    | Optional                 | Optional                 | Optional                 | -                        | -                        | -               | -                        | -                        |
| Glass Lid  |    | -                        | -                        | -                        | -                        | -                        | -               | -                        | -                        |
| Burner Safety Valves   |    | Standard                 | Standard                 | Standard                 | Standard                 | Standard                 | Standard        | Standard                 | Standard                 |
| Button Ignition  |    | Optional                 | Optional                 | Optional                 | Optional                 | -                        | -               | Optional                 | -                        |
| One-touch-Ignition through knobs   |    | Optional                 | Optional                 | Optional                 | Optional                 | Optional                 | Standard        | Optional                 | Optional                 |
| Enamel Pan Supports  |    | Standard                 | Standard                 | Standard                 | Standard                 | Standard                 | -               | Standard                 | Standard                 |
| Cast Iron Pan Supports   |    | Optional                 | Optional                 | -                        | Optional                 | Optional                 | Standard        | Optional                 | Optional                 |
| Cast Iron Burner Caps  |    | Optional                 | Optional                 | -                        | Optional                 | Optional                 | Optional        | Optional                 | Optional                 |
| Coffee Adaptor   |    | Optional                 | Optional                 | Optional                 | Optional                 | Optional                 | Optional        | Optional                 | Optional                 |
| Wok Adaptor  |    | Optional                 | Optional                 | Optional                 | Optional                 | Optional                 | -               | Optional                 | Optional                 |
| Vitroceraic Glass Cleaning Spatula   |    | -                        | -                        | -                        | -                        | -                        | -               | -                        | -                        |
| Gas Conversion Kit   |    | Standard                 | Standard                 | Standard                 | Standard                 | Standard                 | Standard        | Standard                 | Standard                 |
| Others   |    |                          |                          |                          |                          |                          |                 |                          |                          |
| Total Gas Power (Depends on Model) Maximum   | kW | 8,3                      | 8,3                      | 8,1                      | 8,1                      | 7,7                      | 7,5             | 11,1                     | 11,1                     |
| Total Electric Power (Depends on Model) Maximum  | kW | 1,5                      | 1,5                      | 1                        | 1                        | 1                        | -               | 1                        | 1                        |
| Voltage  | V  | 230V~                    | 230V~                    | 230V~                    | 230V~                    | 230V~                    | 230V~           | 230V~                    | 230V~                    |
| RoHS Compliance  |    | Standard                 | Standard                 | Standard                 | Standard                 | Standard                 | Standard        | Standard                 | Standard                 |
| CE Compliance  |    | Standard                 | Standard                 | Standard                 | Standard                 | Standard                 | Standard        | Standard                 | Standard                 |
| Carton Box Packaging   |    | Standard                 | Standard                 | Standard                 | Standard                 | Standard                 | Standard        | Standard                 | Standard                 |
| Packed Product Dimensions (WxDxH)  | mm | 626 x 580 x 140          | x                        | 626 x 560 x 130          | 641 x 576 x 161          | x                        | x               | 731 x 576 x 161          | x                        |
| Packed Product Dimensions (WxDxH) Box  | mm | 640 x 584 x 152          | 647 x 582 x 164          | 635 x 564 x 142          | x                        | 647 x 582 x 164          | 647 x 582 x 164 | x                        | 769 x 582 x 164          |
| Net Weight (Depends on Model) Maximum  | kg | 9                        | 9,5                      | 6,6                      | 9,8                      | 9,5                      | 11              | 10,7                     | 12,5                     |
| Gross Weight (Depends on Model) Maximum  | kg | 9,75                     | 10,5                     | 7,5                      | 10,6                     | 10,5                     | 12              | 11,6                     | 13,5                     |

# HOB SPECIFICATIONS

| BUILT-IN / TABLE-TOP HOB SPECIFICATION SHEET   |    | BI Gas Securit Hobs |                 |                 |                 |                 |                 |                 |                 |
|--|----|---------------------|-----------------|-----------------|-----------------|-----------------|-----------------|-----------------|-----------------|
|  |    | 60 CM               | 60 CM           | 60 CM           | 60 CM           | 60 CM           | 70 CM           | 70 CM           | 90 CM           |
|  |    | Securit II          | Trio            | Model I         | PlusX           | Division        | Model I         | PlusX           |                 |
| Available Colours  |    |                     |                 |                 |                 |                 |                 |                 |                 |
| White  |    | Optional            | Optional        | Optional        | Optional        | -               | Optional        | Optional        | Optional        |
| Brown  |    | Optional            | Optional        | Optional        | Optional        | -               | Optional        | Optional        | Optional        |
| Terre de France  |    | Optional            | Optional        | Optional        | Optional        | -               | Optional        | Optional        | Optional        |
| Black  |    | Standard            | Standard        | Standard        | Standard        | Standard        | Standard        | Standard        | Standard        |
| Dark Green   |    | Optional            | Optional        | Optional        | Optional        | -               | Optional        | Optional        | Optional        |
| Stainless Steel  |    | -                   | -               | -               | -               | -               | -               | -               | -               |
| Product Dimensions   |    |                     |                 |                 |                 |                 |                 |                 |                 |
| Height (max., varies from model to model)  | mm | 44                  | 44              | 39,5            | 44              | 44              | 39,5            | 44              | 47              |
| Width  | mm | 594                 | 594             | 590             | 594             | 594             | 680             | 700             | 882             |
| Depth (max., do not include gas connection detail)   | mm | 523                 | 523             | 515             | 523             | 523             | 515             | 520             | 520             |
| Cut-out Dimensions   |    |                     |                 |                 |                 |                 |                 |                 |                 |
| Width  | mm | 560                 | 560             | 560             | 560             | 560             | 560             | 560             | 850             |
| Depth  | mm | 490                 | 490             | 490             | 490             | 490             | 490             | 490             | 480             |
| Hob Features   |    |                     |                 |                 |                 |                 |                 |                 |                 |
| Hob  |    | Securit             | Securit         | Securit         | Securit         | Securit         | Securit         | Securit         | Securit         |
| Rapid Gas Burner Ø10cm   | W  | 3000                | 3000            | 3000            | 3000            | 3000            | 3000            | 3000            | 3000            |
| Semi-rapid Gas Burner Ø7,5cm   | W  | 1750                | 1750            | 1750            | 1750            | 1750            | 1750            | 1750            | 1750            |
| Auxiliary Gas Burner Ø5,5cm  | W  | 1000                | 1000            | 1000            | 1000            | 1000            | 1000            | 1000            | 1000            |
| Wok (Triple Flame) Gas Burner Mono Ø14cm   | W  | 3800                | 3600            | 3800            | 3600            | -               | 3800            | 3600            | 4500            |
| Wok (Triple Flame) Gas Burner Dual Ø14cm   | W  | -                   | -               | -               | -               | -               | -               | -               | 4500            |
| Wok (Triple Flame) Gas Burner Ø11cm  | W  | -                   | -               | -               | -               | -               | -               | -               | -               |
| Ø 145 mm Hotplate  | W  | -                   | -               | -               | 1000            | -               | -               | -               | -               |
| Ø 180 mm Hotplate  | W  | -                   | -               | -               | -               | -               | -               | -               | -               |
| Ø 145 mm Rapid Hotplate  | W  | -                   | -               | -               | -               | -               | -               | -               | -               |
| Ø 180 mm Rapid Hotplate  | W  | -                   | -               | -               | -               | -               | -               | -               | -               |
| Ø145 mm Highlite Element   | W  | -                   | -               | -               | -               | -               | -               | -               | -               |
| Ø180 mm Highlite Element   | W  | -                   | -               | -               | -               | -               | -               | -               | -               |
| Ø210 mm Highlite Element   | W  | -                   | -               | -               | -               | -               | -               | -               | -               |
| Ø180 mm Dual Highlite Element  | W  | -                   | -               | -               | -               | -               | -               | -               | -               |
| Ø145 mm Oval Highlite Element  | W  | -                   | -               | -               | -               | -               | -               | -               | -               |
| Ø210 mm Dual Highlite Element  | W  | -                   | -               | -               | -               | -               | -               | -               | -               |
| Ø210 mm Triple Highlite Element  | W  | -                   | -               | -               | -               | -               | -               | -               | -               |
| Ø290 mm Dual/Triple Highlite Element   | W  | -                   | -               | -               | -               | -               | -               | -               | -               |
| Ø 160 mm Induction Zone(Serie 1 and Serie 2)   | W  | -                   | -               | -               | -               | -               | -               | -               | -               |
| Ø 200 mm Induction Zone(Serie 1)   | W  | -                   | -               | -               | -               | -               | -               | -               | -               |
| Ø 210 mm Induction Zone(Serie 2)   | W  | -                   | -               | -               | -               | -               | -               | -               | -               |
| Ø 250 mm Induction Zone(Serie 1)   | W  | -                   | -               | -               | -               | -               | -               | -               | -               |
| Ø 290 mm Induction Zone(Serie 2)   | W  | -                   | -               | -               | -               | -               | -               | -               | -               |
| Boost Function   |    | -                   | -               | -               | -               | -               | -               | -               | -               |
| Pot Dedection  |    | -                   | -               | -               | -               | -               | -               | -               | -               |
| Automatic Heatup   |    | -                   | -               | -               | -               | -               | -               | -               | -               |
| Timer function for vitro ceramic hobs (If touch control with some hob configuration selected)    |    | -                   | -               | -               | -               | -               | -               | -               | -               |
| Mode function for induction ceramic hobs (If touch control with some hob configuration selected) |    | -                   | -               | -               | -               | -               | -               | -               | -               |
| Bridge zone for induction ceramic hobs (If touch control with some hob configuration selected)   |    | -                   | -               | -               | -               | -               | -               | -               | -               |
| Child Lock for vitro ceramic hobs (If touch control selected)                                    |    | -                   | -               | -               | -               | -               | -               | -               | -               |
| Mechanical Child Lock (Main Switch)  |    | -                   | -               | -               | -               | -               | -               | -               | Optional        |
| Hot Surface Indicator Light  |    | -                   | -               | -               | -               | -               | -               | -               | -               |
| Hotplate Operation Indicator Light   |    | -                   | -               | Standard        | Standard        | -               | -               | -               | -               |
| Side Knob Control  |    | Standard            | Standard        | -               | -               | -               | -               | -               | -               |
| Side Touch Control   |    | -                   | -               | -               | -               | -               | -               | -               | -               |
| Front Knob Control   |    | -                   | -               | Standard        | Standard        | -               | Standard        | Standard        | Standard        |
| Double Side Front Control  |    | -                   | -               | -               | -               | Standard        | -               | -               | -               |
| Front Triangular Touch Control   |    | -                   | -               | -               | -               | -               | -               | -               | -               |
| Front Slider Touch Control   |    | -                   | -               | -               | -               | -               | -               | -               | -               |
| Front Touch Control  |    | -                   | -               | -               | -               | -               | -               | -               | -               |
| Bevelled Edges   |    | -                   | -               | -               | -               | -               | -               | -               | Optional        |
| Logo   |    | Optional            | Optional        | Standard        | Standard        | Standard        | Standard        | Standard        | Standard        |
| Special Decoration on Glass  |    | Optional            | Optional        | -               | -               | -               | -               | -               | -               |
| Vitroceramic Glass Artwork   |    | -                   | -               | -               | -               | -               | -               | -               | -               |
| Inox Frame   |    | -                   | -               | Standard        | -               | -               | Standard        | -               | Optional        |
| Stainless Steel Burner Pan   |    | Optional            | Optional        | Optional        | Optional        | -               | Optional        | Optional        | Optional        |
| Table Top Installation (not built-in)  |    | -                   | -               | -               | -               | -               | -               | -               | -               |
| Glass Lid  |    | -                   | -               | -               | -               | -               | -               | -               | -               |
| Burner Safety Valves   |    | Standard            | Standard        | Standard        | Standard        | Standard        | Standard        | Standard        | Standard        |
| Button Ignition  |    | Optional            | Optional        | Optional        | -               | -               | Optional        | -               | -               |
| One-touch-Ignition through knobs   |    | Optional            | Optional        | Optional        | Optional        | Standard        | Optional        | Optional        | Standard        |
| Enamel Pan Supports  |    | Standard            | Standard        | Standard        | Standard        | -               | Standard        | Standard        | -               |
| Cast Iron Pan Supports   |    | Optional            | Optional        | Optional        | Optional        | Standard        | Optional        | Optional        | Standard        |
| Cast Iron Burner Caps  |    | Optional            | Optional        | Optional        | Optional        | Optional        | Optional        | Optional        | Standard        |
| Coffee Adaptor   |    | Optional            | Optional        | Optional        | Optional        | Optional        | Optional        | Optional        | Optional        |
| Wok Adaptor  |    | Optional            | Optional        | Optional        | Optional        | -               | Optional        | Optional        | Optional        |
| Vitroceramic Glass Cleaning Spatula  |    | -                   | -               | -               | -               | -               | -               | -               | -               |
| Gas Conversion Kit   |    | Standard            | Standard        | Standard        | Standard        | Standard        | Standard        | Standard        | Optional        |
| Others   |    |                     |                 |                 |                 |                 |                 |                 |                 |
| Total Gas Power (Depends on Model) Maximum   | kW | 8,3                 | 8,1             | 8,3             | 8,1             | 7,5             | 11,3            | 11,1            | 12              |
| Total Electric Power (Depends on Model) Maximum  | kW | -                   | -               | -               | 1               | -               | -               | -               | -               |
| Voltage  | V  | 230V-               | 230V-           | 230V-           | 230V-           | 230V-           | 230V-           | 230V-           | 230V-           |
| RoHS Compliance  |    | Standard            | Standard        | Standard        | Standard        | Standard        | Standard        | Standard        | Standard        |
| CE Compliance  |    | Standard            | Standard        | Standard        | Standard        | Standard        | Standard        | Standard        | Standard        |
| Carton Box Packaging   |    | Standard            | Standard        | Standard        | Standard        | Standard        | Standard        | Standard        | Standard        |
| Packed Product Dimensions (WxDxH)  | mm | 622 x 580 x 140     | 622 x 580 x 140 | 641 x 576 x 161 | x               | x               | 731 x 576 x 161 | x               | x               |
| Packed Product Dimensions (WxDxH) Box  | mm | x                   | x               | x               | 647 x 582 x 164 | 647 x 582 x 164 | x               | 769 x 582 x 164 | 935 x 582 x 164 |
| Net Weight (Depends on Model) Maximum  | kg | 9,5                 | 9,5             | 10,7            | 11,5            | -               | 13,7            | 13,8            | 20,5            |
| Gross Weight (Depends on Model) Maximum  | kg | 10,25               | 10,25           | 11,13           | 12,5            | -               | 14,2            | 14,8            | 21,5            |

| BUILT-IN / TABLE-TOP HOB SPECIFICATION SHEET   | BI Electric Hobs |                          | BI Vitro Ceramic Hobs |                    | BI Induction Ceramic Hobs        |                                  |                                  |
|--|------------------|--------------------------|-----------------------|--------------------|----------------------------------|----------------------------------|----------------------------------|
|  | 60 CM            | 60 CM                    | 78 CM                 | 60 CM              | 78 CM                            | 90CM                             |                                  |
|  | Flat / Surface   | C Serie                  | C Serie               | Vestel Induction   | Vestel Induction                 | Vestel Induction                 |                                  |
| Available Colours  |                  |                          |                       |                    |                                  |                                  |                                  |
| White  | Standard         | Optional                 | Optional              | Optional           | Optional                         | Optional                         | Optional                         |
| Brown  | Optional         | -                        | -                     | -                  | -                                | -                                | -                                |
| Terre de France  | Optional         | -                        | -                     | -                  | -                                | -                                | -                                |
| Black  | Optional         | Standard                 | Standard              | Standard           | Standard                         | Standard                         | Standard                         |
| Dark Green   | Optional         | -                        | -                     | -                  | -                                | -                                | -                                |
| Stainless Steel  | Optional         | -                        | -                     | -                  | -                                | -                                | -                                |
| Product Dimensions   |                  |                          |                       |                    |                                  |                                  |                                  |
| Height (max., varies from model to model)  | mm               | 40                       | 41- 47,5              | 41                 | 56                               | 56                               | 56                               |
| Width  | mm               | 580                      | 590                   | 780                | 590                              | 590                              | 890                              |
| Depth (max., do not include gas connection detail)   | mm               | 510                      | 520                   | 520                | 520                              | 520                              | 520                              |
| Cut-out Dimensions   |                  |                          |                       |                    |                                  |                                  |                                  |
| Width  | mm               | 560                      | 560                   | 750                | 560                              | 750                              | 860                              |
| Depth  | mm               | 490                      | 490                   | 490                | 490                              | 490                              | 490                              |
| Hob Features   |                  |                          |                       |                    |                                  |                                  |                                  |
| Hob  |                  | Enamel / Stainless Steel | Vitro Ceramic         | Vitro Ceramic      | Induction Ceramic                | Induction Ceramic                | Induction Ceramic                |
| Rapid Gas Burner Ø10cm   | W                | -                        | -                     | -                  | -                                | -                                | -                                |
| Semi-rapid Gas Burner Ø7.5cm   | W                | -                        | -                     | -                  | -                                | -                                | -                                |
| Auxiliary Gas Burner Ø5.5cm  | W                | -                        | -                     | -                  | -                                | -                                | -                                |
| Wok (Triple Flame) Gas Burner Mono Ø14cm   | W                | -                        | -                     | -                  | -                                | -                                | -                                |
| Wok (Triple Flame) Gas Burner Dual Ø14cm   | W                | -                        | -                     | -                  | -                                | -                                | -                                |
| Wok (Triple Flame) Gas Burner Ø11cm  | W                | -                        | -                     | -                  | -                                | -                                | -                                |
| Ø 145 mm Hotplate  | W                | 1000                     | -                     | -                  | -                                | -                                | -                                |
| Ø 180 mm Hotplate  | W                | 1500                     | -                     | -                  | -                                | -                                | -                                |
| Ø 145 mm Rapid Hotplate  | W                | 1500                     | -                     | -                  | -                                | -                                | -                                |
| Ø 180 mm Rapid Hotplate  | W                | 2000                     | -                     | -                  | -                                | -                                | -                                |
| Ø145 mm Highlite Element   | W                | -                        | 1200                  | 1200               | -                                | -                                | -                                |
| Ø180 mm Highlite Element   | W                | -                        | 1800                  | 1800               | -                                | -                                | -                                |
| Ø210 mm Highlite Element   | W                | -                        | 2300                  | 2300               | -                                | -                                | -                                |
| Ø180 mm Dual Highlite Element  | W                | -                        | 1700                  | 1700               | -                                | -                                | -                                |
| Ø145 mm Oval Highlite Element  | W                | -                        | 1800                  | 1800               | -                                | -                                | -                                |
| Ø210 mm Dual Highlite Element  | W                | -                        | 2200                  | 2200               | -                                | -                                | -                                |
| Ø210 mm Triple Highlite Element  | W                | -                        | 2300                  | 2300               | -                                | -                                | -                                |
| Ø290 mm Dual/Triple Highlite Element   | W                | -                        | 2700                  | -                  | -                                | -                                | -                                |
| Ø 160 mm Induction Zone(Serie 1 and Serie 2)   | W                | -                        | -                     | -                  | Nominal 1400 W max. Boost 1800 W | Nominal 1400 W max. Boost 1800 W | Nominal 1400 W max. Boost 1800 W |
| Ø 200 mm Induction Zone(Serie 1)   | W                | -                        | -                     | -                  | Nominal 2100 W max. Boost 2500 W | Nominal 2100 W max. Boost 2500 W | Nominal 2100 W max. Boost 2500 W |
| Ø 210 mm Induction Zone(Serie 2)   | W                | -                        | -                     | -                  | Nominal 2100 W max. Boost 2500 W | -                                | -                                |
| Ø 250 mm Induction Zone(Serie 1)   | W                | -                        | -                     | -                  | Nominal 2800 W max. Boost 3500 W | Nominal 2800 W max. Boost 3500 W | Nominal 2800 W max. Boost 3500 W |
| Ø 290 mm Induction Zone(Serie 2)   | W                | -                        | -                     | -                  | Nominal 2800 W max. Boost 3500 W | -                                | -                                |
| Boost Funcion  |                  |                          |                       |                    | Standard                         | Standard                         | Standard                         |
| Pot Dedection  |                  |                          |                       |                    | Standard                         | Standard                         | Standard                         |
| Automatic Heatup   |                  |                          |                       |                    | -                                | -                                | -                                |
| Timer function for vitro ceramic hobs (If touch control with some hob configuration selected)    |                  |                          | Optional              | Optional           | Optional                         | Optional                         | Standard                         |
| Mode function for induction ceramic hobs (If touch control with some hob configuration selected) |                  |                          | -                     | -                  | Optional                         | Optional                         | -                                |
| Bridge zone for induction ceramic hobs (If touch control with some hob configuration selected)   |                  |                          | -                     | -                  | Optional                         | -                                | -                                |
| Child Lock for vitro ceramic hobs (If touch control selected)                                    |                  |                          | Standard              | Standard           | Standard                         | Standard                         | Standard                         |
| Mechanical Child Lock (Main Switch)  |                  |                          | -                     | -                  | -                                | -                                | -                                |
| Hot Surface Indicator Light  |                  |                          | Standard              | Standard           | Standard                         | Standard                         | Standard                         |
| Hotplate Operation Indicator Light   |                  | Standard                 | -                     | -                  | -                                | -                                | -                                |
| Side Knob Control  |                  | Standard                 | Standard              | -                  | -                                | -                                | -                                |
| Side Touch Control   |                  | -                        | Optional              | -                  | -                                | -                                | -                                |
| Front Knob Control   |                  | -                        | -                     | -                  | -                                | -                                | -                                |
| Double Side Front Control  |                  | -                        | -                     | -                  | -                                | -                                | -                                |
| Front Triangular Touch Control   |                  | -                        | Optional              | Standard           | -                                | -                                | -                                |
| Front Slider Touch Control   |                  | -                        | Optional              | Optional           | Optional                         | Optional                         | -                                |
| Front Touch Control  |                  | -                        | -                     | -                  | Optional                         | Optional                         | Optional                         |
| Bevelled Edges   |                  | -                        | Optional              | Optional           | Optional                         | Optional                         | Optional                         |
| Logo   |                  | Standard                 | Optional              | Optional           | Optional                         | Optional                         | Optional                         |
| Special Decoration on Glass  |                  | -                        | Optional              | Optional           | Optional                         | Optional                         | Optional                         |
| Vitroceramic Glass Artwork   |                  | -                        | Slim / Arc / Point    | Slim / Arc / Point | Slim / Plus / Line               | Slim / Plus / Line               | Slim / Plus / Line               |
| Inox Frame   |                  | -                        | Optional              | -                  | Optional                         | Optional                         | Optional                         |
| Stainless Steel Burner Pan   |                  | -                        | -                     | -                  | -                                | -                                | -                                |
| Table Top Installation (not built-in)  |                  | -                        | -                     | -                  | -                                | -                                | -                                |
| Glass Lid  |                  | -                        | -                     | -                  | -                                | -                                | -                                |
| Burner Safety Valves   |                  | -                        | -                     | -                  | -                                | -                                | -                                |
| Button Ignition  |                  | -                        | -                     | -                  | -                                | -                                | -                                |
| One-touch-ignition through knobs   |                  | -                        | -                     | -                  | -                                | -                                | -                                |
| Enamel Pan Supports  |                  | -                        | -                     | -                  | -                                | -                                | -                                |
| Cast Iron Pan Supports   |                  | -                        | -                     | -                  | -                                | -                                | -                                |
| Cast Iron Burner Caps  |                  | -                        | -                     | -                  | -                                | -                                | -                                |
| Coffee Adaptor   |                  | -                        | -                     | -                  | -                                | -                                | -                                |
| Wok Adaptor  |                  | -                        | -                     | -                  | -                                | -                                | -                                |
| Vitroceramic Glass Cleaning Spatula  |                  | -                        | Optional              | Optional           | Optional                         | Optional                         | Optional                         |
| Gas Conversion Kit   |                  | -                        | -                     | -                  | -                                | -                                | -                                |
| Others   |                  |                          |                       |                    |                                  |                                  |                                  |
| Total Gas Power (Depends on Model) Maximum   | kW               | -                        | -                     | -                  | -                                | -                                | -                                |
| Total Electric Power (Depends on Model) Maximum  | kW               | 6                        | 6,5                   | 8,3                | 7,4                              | 7,4                              | 10,8                             |
| Voltage  | V                | 230V~ / 400V 2N~         | 230V~ / 400V 3N~      | 230V~ / 400V 3N~   | 230V~ / 400V 3N~                 | 230V~ / 400V 3N~                 | 230V~ / 400V 3N~                 |
| RoHS Compliance  |                  | Standard                 | Standard              | Standard           | Standard                         | Standard                         | Standard                         |
| CE Compliance  |                  | Standard                 | Standard              | Standard           | Standard                         | Standard                         | Standard                         |
| Carton Box Packaging   |                  | Standard                 | Standard              | Standard           | Standard                         | Standard                         | Standard                         |
| Packed Product Dimensions (WxDxH)  | mm               | 626 x 580 x 140          | 620 x 578 x 133       | 810 x 578 x 133    | 626 x 581 x 142                  | 816 x 581 x 142                  | 926 x 581 x 142                  |
| Packed Product Dimensions (WxDxH) Box  | mm               | 640 x 584 x 152          | 631 x 580 x 143       | x                  | 643 x 583 x 152                  | x                                | 941 x 583 x 152                  |
| Net Weight (Depends on Model) Maximum  | kg               | 9,5                      | 9,5                   | 10,15              | 11                               | 12                               | 16                               |
| Gross Weight (Depends on Model) Maximum  | kg               | 10,25                    | 10,25                 | 11                 | 12                               | 13                               | 17                               |





## VIFTC.16

### STANDARD FEATURES

- 90 cm induction ceramic hob
- Front touch control
- Booster function
- 2 Ø 160 mm 1400 W / Boost 1800 W induction element
- 2 Ø 200 mm 2100 W / Boost 2500 W induction element
- 1 Ø 250 mm 2800 W / Boost 3500 W induction element
- Pot detection
- Child lock
- Hot surface indicator
- Timer
- Slim design ceran glass serigraphy
- Key Lock
- Smart Pause

### OPTIONAL FEATURES

- Two side inox frame

## VIFTC.01

### STANDARD FEATURES

- 78 cm induction ceramic hob
- Booster function
- 2 Ø 160 mm 1400 W / Boost 1800 W induction element
- 2 Ø 200 mm 2100 W / Boost 2500 W induction element
- Pot detection
- Key lock
- Child lock
- Hot surface indicator
- Smart Pause

### OPTIONAL FEATURES

- Slider touch control
- Timer
- Two side inox frame
- Front side bevelled edge glass
- Mode function

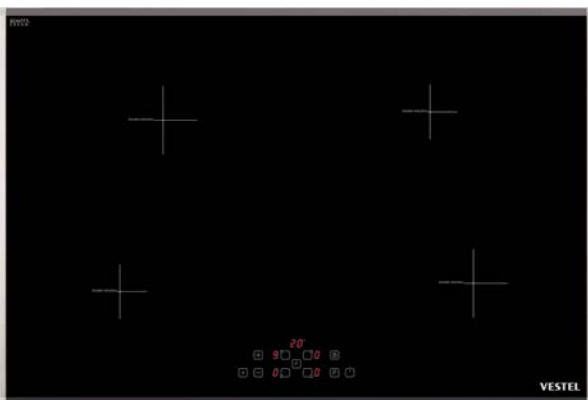
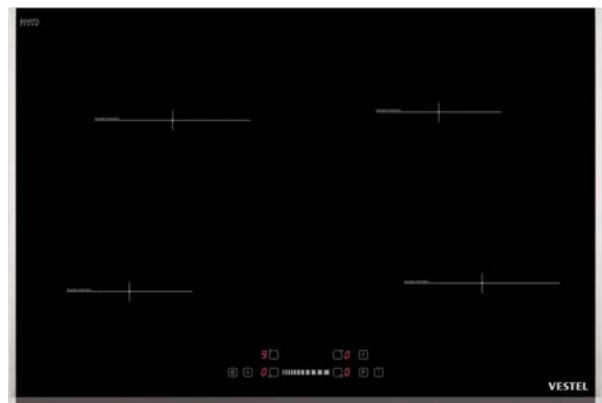

## VIFTC.02

### STANDARD FEATURES

- 78 cm induction ceramic hob
- Booster function
- 2 Ø 160 mm 1400 W / Boost 1800 W induction element
- 2 Ø 200 mm 2100 W / Boost 2500 W induction element
- Pot detection
- Key lock
- Child lock
- Hot surface indicator
- Smart Pause

### OPTIONAL FEATURES

- Slider touch control
- Timer
- Bevelled edge glass
- Mode function



## VIFTC.04

### STANDARD FEATURES

78 cm induction ceramic hob  
 Front touch control  
 Booster function  
 2 Ø 160 mm 1400 W / Boost 1800 W induction element  
 2 Ø 200 mm 2100 W / Boost 2500 W induction element  
 Pot detection

Key lock  
 Child lock  
 Hot surface indicator  
 Smart Pause

### OPTIONAL FEATURES

Timer  
 Two side inox frame  
 Front and back side bevelled edge glass  
 Mode function

## VIFTC.05

### STANDARD FEATURES

78 cm induction ceramic hob  
 Front touch control  
 Booster function  
 2 Ø 160 mm 1400 W / Boost 1800 W induction element  
 2 Ø 200 mm 2100 W / Boost 2500 W induction element  
 Pot detection

Key lock  
 Child lock  
 Hot surface indicator  
 Smart Pause

### OPTIONAL FEATURES

Timer  
 Bevelled edge glass

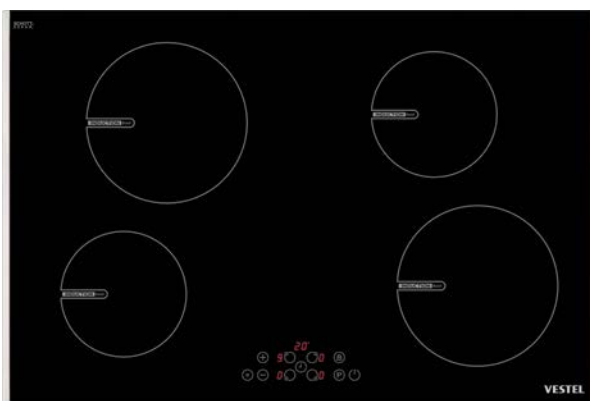
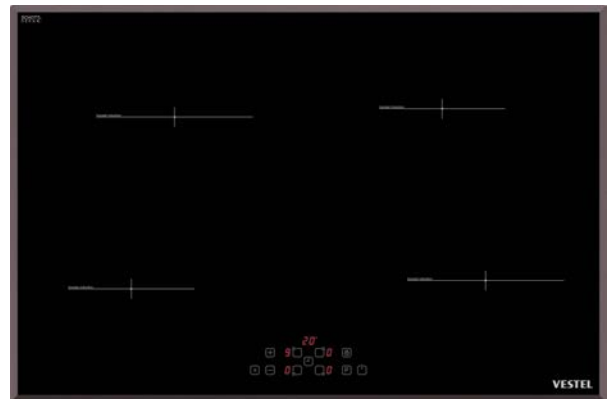

## VIFTC.06

### STANDARD FEATURES

78 cm induction ceramic hob  
 Front touch control  
 Booster function  
 2 Ø 160 mm 1400 W / Boost 1800 W induction element  
 2 Ø 200 mm 2100 W / Boost 2500 W induction element  
 Pot detection

Key lock  
 Child lock  
 Hot surface indicator  
 Smart Pause

### OPTIONAL FEATURES

Timer  
 Two side inox frame  
 Mode function

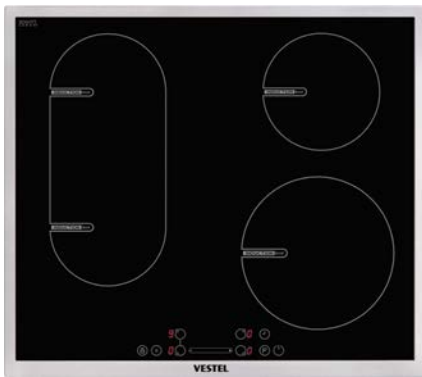

## VIFTC.18

### STANDARD FEATURES

60 cm induction ceramic hob  
 Booster function  
 3 Ø 160 mm 1400 W / Boost 1800 W  
 induction element  
 1 Ø 210 mm 2100 W / Boost 2500 W  
 induction element  
 Pot Detection  
 Child lock  
 Hot surface indicator  
 Key lock  
 Smart pause

### OPTIONAL FEATURES

Slider touch control  
 Timer  
 Full inox frame  
 Line design  
 Ceran glass serigraphy  
 Birdge zone  
 Mode function

## VIFTC.08

### STANDARD FEATURES

60 cm induction ceramic hob  
 Booster function  
 2 Ø 160 mm 1400 W / Boost 1800 W  
 induction element  
 2 Ø 210 mm 2100 W / Boost 2500 W  
 induction element  
 Pot detection  
 Key lock  
 Child lock  
 Hot surface indicator  
 Smart Pause

### OPTIONAL FEATURES

Slider touch control  
 Timer  
 Two side inox frame  
 Front and back side bevelled  
 edge glass  
 Mode function

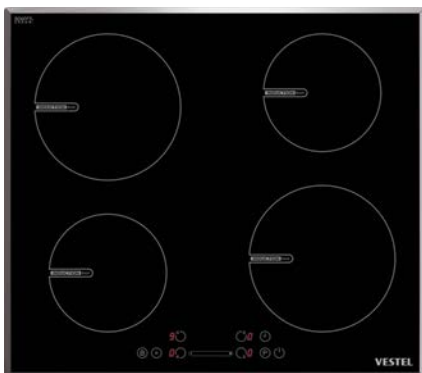
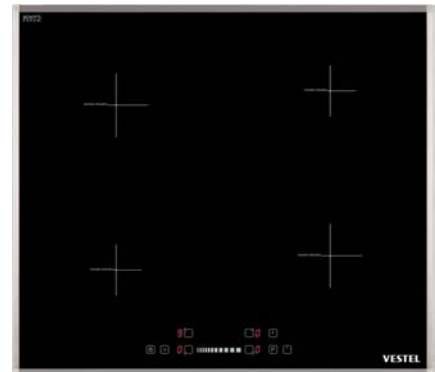

## VIFTC.09

### STANDARD FEATURES

60 cm induction ceramic hob  
 Booster function  
 2 Ø 160 mm 1400 W / Boost 1800 W  
 induction element  
 2 Ø 210 mm 2100 W / Boost 2500 W  
 induction element  
 Pot detection  
 Key lock  
 Child lock  
 Hot surface indicator  
 Smart Pause

### OPTIONAL FEATURES

Slider touch control  
 Timer  
 Bevelled edge glass  
 Mode function

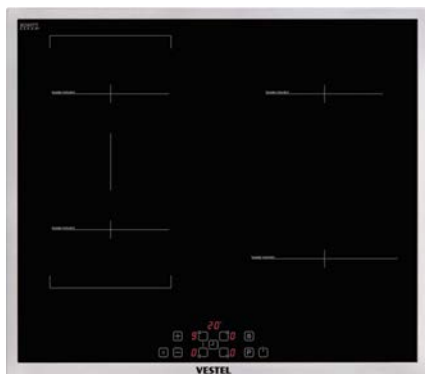

## VIFTC.17

### STANDARD FEATURES

60 cm induction ceramic hob  
 Front touch control  
 Booster function  
 3 Ø 160 mm 1400 W / Boost 1800 W  
 induction element  
 1 Ø 210 mm 2100 W / Boost 2500 W  
 induction element  
 Pot Detection  
 Child lock  
 Hot surface indicator  
 Key lock  
 Smart pause

### OPTIONAL FEATURES

Timer  
 Full inox frame  
 Line design ceran glass serigraphy  
 Bridge Zone  
 Mode function

## VIFTC.10

### STANDARD FEATURES

60 cm induction ceramic hob  
 Booster function  
 1 Ø 160 mm 1400 W / Boost 1800 W  
 induction element  
 1 Ø 210 mm 2100 W / Boost 2500 W  
 induction element  
 1 Ø 290 mm 2800 W / Boost 3500 W  
 induction element  
 Pot detection  
 Key lock  
 Child lock

Hot surface indicator  
 Smart Pause

### OPTIONAL FEATURES

Slider touch control  
 Timer

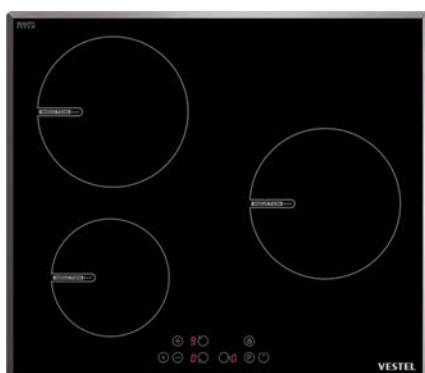
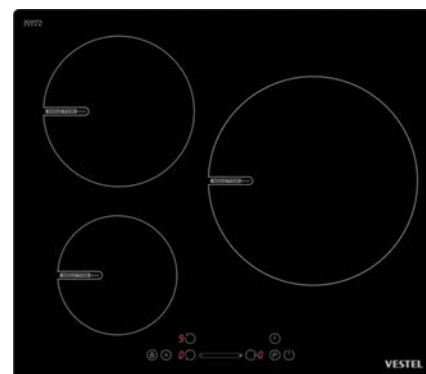

## VIFTC.14

### STANDARD FEATURES

60 cm induction ceramic hob  
 Front touch control  
 Booster function  
 1 Ø 160 mm 1400 W / Boost 1800 W  
 induction element  
 2 Ø 210 mm 2100 W / Boost 2500 W  
 induction element  
 Pot detection  
 Key lock  
 Child lock

Hot surface indicator  
 Smart Pause

### OPTIONAL FEATURES

Bevelled edge glass

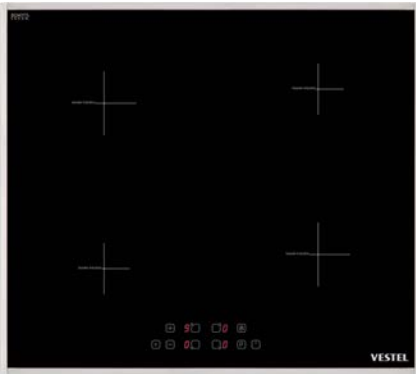

## VIFTC.12

### STANDARD FEATURES

- 60 cm induction ceramic hob
- Front touch control
- Booster function
- 2 Ø 160 mm 1400 W / Boost 1800 W induction element
- 2 Ø 210 mm 2100 W / Boost 2500 W induction element
- Pot detection
- Key lock
- Child lock
- Hot surface indicator
- Smart Pause

### OPTIONAL FEATURES

- Inox frame

## VIFTC.13

### STANDARD FEATURES

- 60 cm induction ceramic hob
- Front touch control
- Booster function
- 2 Ø 160 mm 1400 W / Boost 1800 W induction element
- 2 Ø 210 mm 2100 W / Boost 2500 W induction element
- Pot detection
- Key lock
- Child lock
- Hot surface indicator
- Smart Pause

### OPTIONAL FEATURES

- Timer
- Mode function

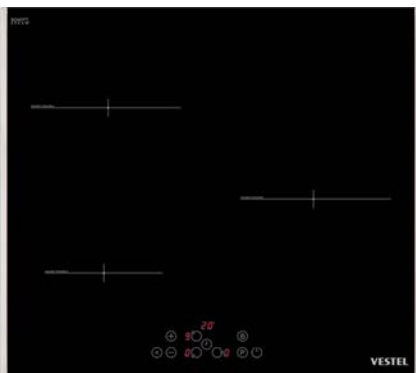
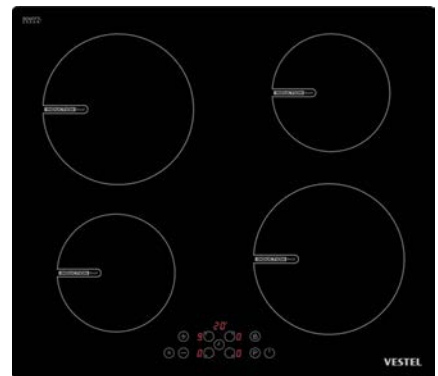

## VIFTC.15

### STANDARD FEATURES

- 60 cm induction ceramic hob
- Front touch control
- Booster function
- 1 Ø 160 mm 1400 W / Boost 1800 W induction element
- 2 Ø 210 mm 2100 W / Boost 2500 W induction element
- Pot detection
- Key lock
- Child lock

- Hot surface indicator
- Smart Pause

### OPTIONAL FEATURES

- Timer
- Two side inox frame



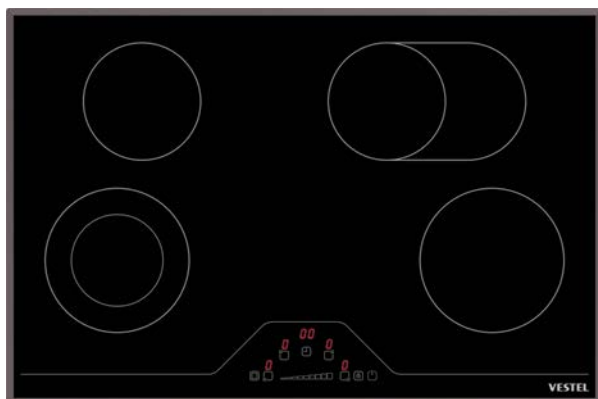

## VFTC.01

### STANDARD FEATURES

78 cm ceramic hob  
 1 Ø 145 mm Highlite  
 Element 1200W  
 1 Ø 180 mm Highlite  
 Element 1800W  
 Child lock  
 Hot surface indicator  
 Key Lock  
 Smart pause (with slider)

### OPTIONAL FEATURES

Slider touch control  
 Ø 145 mm Oval Highlite  
 Element 1000W/1800W  
 Ø 180 mm Dual Highlite  
 Element 700W/1700W  
 Timer  
 Bevelled edge glass

## VFTC.03

### STANDARD FEATURES

78 cm ceramic hob  
 Front touch control  
 2 Ø 145 mm Highlite  
 Element 1200W  
 Child lock  
 Hot surface indicator  
 Key Lock

### OPTIONAL FEATURES

Ø 145 mm Oval Highlite  
 Element 1000W/1800W  
 Ø 210 mm Highlite Element  
 2300W

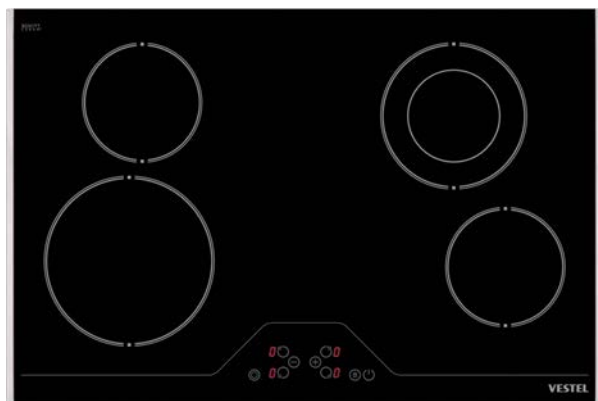
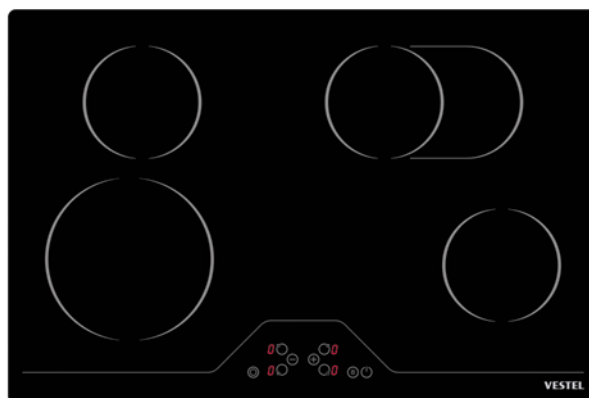

## VFTC.13

### STANDARD FEATURES

78 cm ceramic hob  
 Front touch control  
 2 Ø 145 mm Highlite  
 Element 1200W  
 Child Lock  
 Hot surface indicator  
 Key lock

### OPTIONAL FEATURES

1 Ø 210 mm Highlite  
 Element 2300W  
 1 Ø 180mm Dual Highlite  
 Element 700W/1700W  
 Two side inox frame

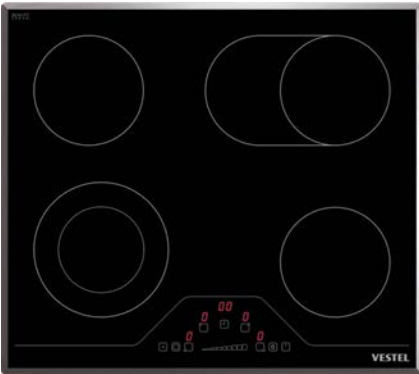

## VFTC.04

### STANDARD FEATURES

- 60 cm ceramic hob
- 2 Ø 145 mm Highlite Element 1200W
- Child lock
- Hot surface indicator
- Key Lock
- Smart pause (with slider)

### OPTIONAL FEATURES

- Slider touch control
- Ø 180 mm Dual Highlite Element 700W/1700W
- Ø 145 mm Oval Highlite Element 1000W/1800W
- Timer
- Bevelled edge glass

## VFTC.05

### STANDARD FEATURES

- 60 cm ceramic hob
- 2 Ø 145 mm Highlite Element 1200W
- Child lock
- Hot surface indicator
- Key Lock

### OPTIONAL FEATURES

- Ø 180 mm Dual Highlite Element 700W/1700W
- Ø 210 mm Triple Highlite Element 800W/1600W/2300W
- Timer
- Two side inox frame

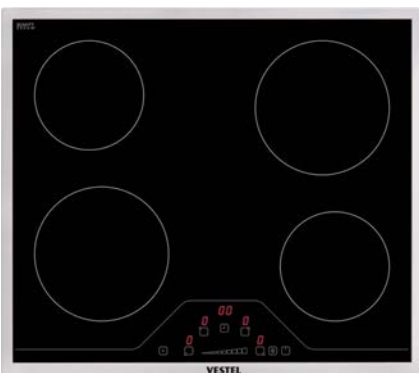
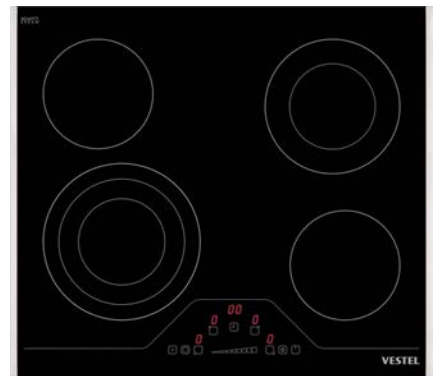

## VFTC.06

### STANDARD FEATURES

- 60 cm ceramic hob
- 2 Ø 145 mm Highlite Element 1200W
- 2 Ø 180 mm Highlite Element 1800W
- Child Lock
- Hot surface indicator
- Slim design ceran glass serigraphy
- Key Lock
- Smart pause (with slider)

### OPTIONAL FEATURES

- Slider touch control
- Timer
- Full inox frame

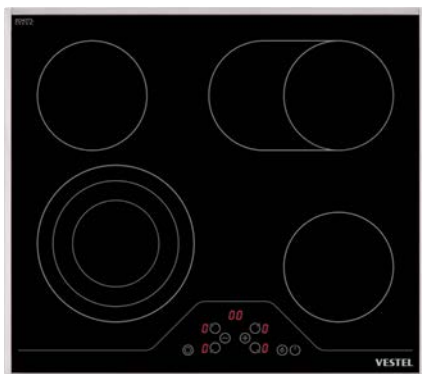

## VFTC.07

### STANDARD FEATURES

60 cm ceramic hob  
 Front touch control  
 2 Ø 145 mm Highlite Element 1200W  
 Child lock  
 Hot surface indicator  
 Key Lock

### OPTIONAL FEATURES

Ø 145 mm Oval Highlite Element  
 1000W/1800W  
 Ø 210 mm Triple Highlite Element  
 800W/1600W/2300W  
 Inox frame

## VFTC.08

### STANDARD FEATURES

60 cm ceramic hob  
 Front touch control  
 2 Ø 145 mm Highlite Element 1200W  
 Ø 180 mm Highlite Element 1800W  
 Child lock  
 Hot surface indicator  
 Key Lock

### OPTIONAL FEATURES

Ø 180 mm Dual Highlite Element  
 700W/1700W  
 Bevelled edge glass  
 White ceramic glass  
 Timer

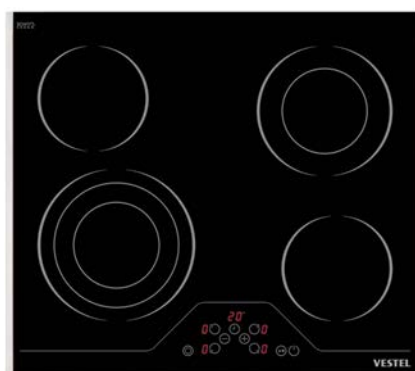
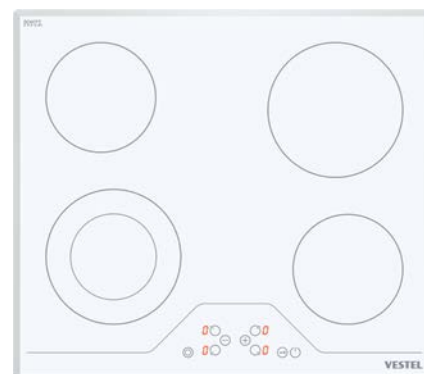

## VFTC.09

### STANDARD FEATURES

60 cm ceramic hob  
 Front touch control  
 2 Ø 145 mm Highlite Element 1200W  
 Child lock  
 Hot surface indicator  
 Key Lock

### OPTIONAL FEATURES

Ø 210 mm Triple Highlite Element  
 800W/1600W/2300W  
 Ø 180 mm Dual Highlite Element  
 700W/1700W  
 Two side inox frame  
 Front side bevelled edge glass

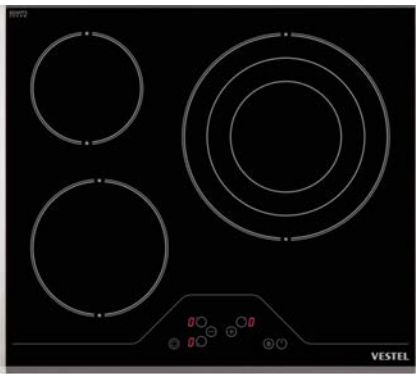

## VFTC.10

### STANDARD FEATURES

- 60 cm ceramic hob
- Front touch control
- Ø 145 mm Highlite Element 1200W
- Ø 180 mm Highlite Element 1800W
- Child lock
- Hot surface indicator
- Key Lock

### OPTIONAL FEATURES

- Ø 270 mm Triple Highlite Element 1050W/1950W/2700W
- Two side inox frame
- Front and back side bevelled edge glass

## VFTC.11

### STANDARD FEATURES

- 60 cm ceramic hob
- Front touch control
- Ø 145 mm Highlite Element 1200W
- Ø 180 mm Highlite Element 1800W
- Child lock
- Hot surface indicator
- Key Lock

### OPTIONAL FEATURES

- Ø 270 mm Dual Highlite Element 1800W/2700W
- Timer
- Front side bevelled edge glass
- Slider touch control

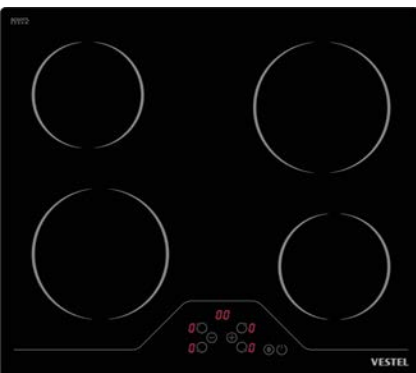
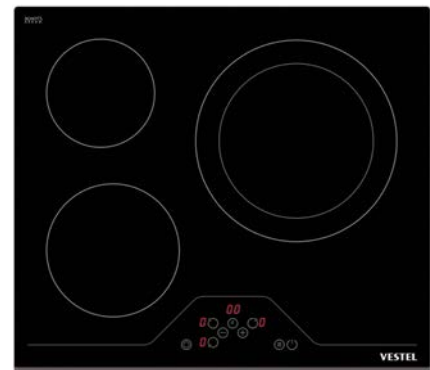

## VFTC.12

### STANDARD FEATURES

- 60 cm ceramic hob
- Front touch control
- 2 Ø 145 mm Highlite Element 1200W
- 2 Ø 180 mm Highlite Element 1800W
- Child lock
- Hot surface indicator
- Key Lock

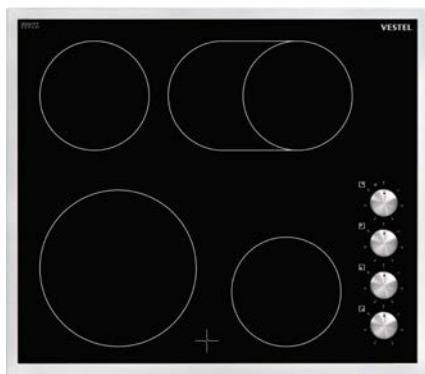

## VKC.07

### STANDARD FEATURES

60 cm ceramic hob  
Side knob control  
2 Ø 145 mm Highlite Element 1200W  
Hot surface indicator light  
Slim design ceran glass serigraphy

### OPTIONAL FEATURES

Ø 145 mm Oval Highlite Element  
1000W/1800W  
210 mm highlite element 2300W  
Full inox frame

## VKC.02

### STANDARD FEATURES

60 cm ceramic hob  
Side knob control  
2 Ø 145 mm Highlite Element 1200W  
Hot surface indicator light

### OPTIONAL FEATURES

Ø 180 mm Dual Highlite Element  
700W/1700W  
Ø 210 mm Highlite Element  
2300W  
Front and back side bevelled edge  
glass  
Inox knobs

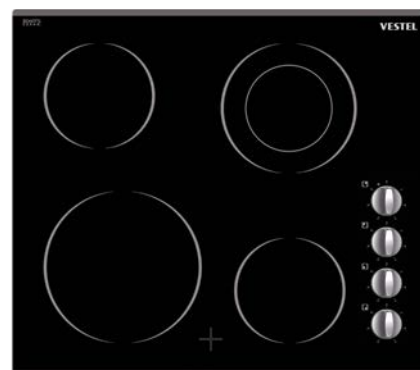

## VKC.03

### STANDARD FEATURES

60 cm ceramic hob  
Side knob control  
2 Ø 145 mm Highlite Element 1200W  
Ø 180 mm Highlite Element 1800W  
Hot surface indicator light

### OPTIONAL FEATURES

Ø 210 mm Highlite Element  
2300W  
Inox knobs

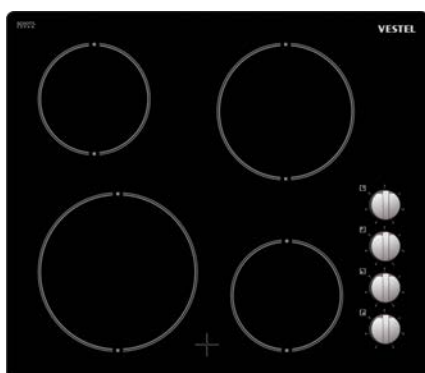



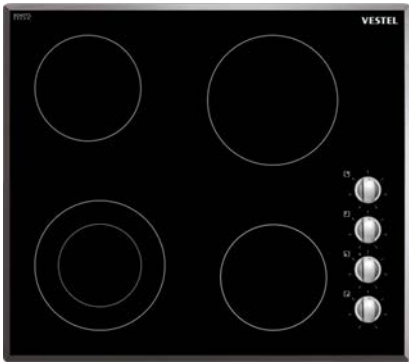

## VKC.04

### STANDARD FEATURES

- 60 cm ceramic hob
- Side knob control
- 2 Ø 145 mm Highlite Element 1200W
- Ø 180 mm Highlite Element 1800W
- Hot surface indicator light

### OPTIONAL FEATURES

- Ø 180 mm Dual Highlite Element 700W/1700W
- Bevelled edge glass
- Inox knobs

## VKC.05

### STANDARD FEATURES

- 60 cm ceramic hob
- Side knob control
- 2 Ø 145 mm Highlite Element 1200W
- Hot surface indicator light

### OPTIONAL FEATURES

- Ø145mm Oval Highlite Element 1000W/1800W
- Ø210mm Highlite Element 2300W
- Front and back side bevelled edge glass
- Metal cladded knobs
- White ceramic glass
- Two side inox frame

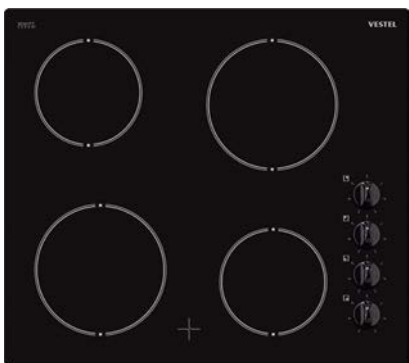
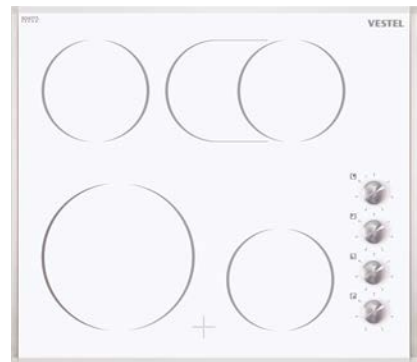

## VKC.06

### STANDARD FEATURES

- 60 cm ceramic hob
- Side knob control
- 2 Ø 145 mm Highlite Element 1200W
- 2 Ø 180 mm Highlite Element 1800W
- Hot surface indicator light

### OPTIONAL FEATURES

- Two side inox frame

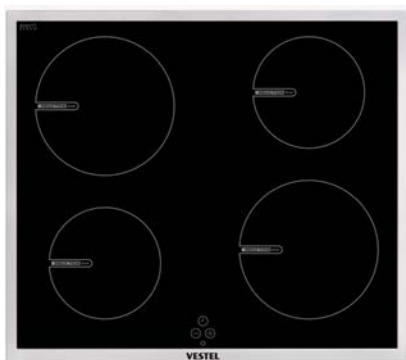

## VICH.01

### STANDARD FEATURES

60 cm induction ceramic hob  
 Combination with oven  
 Knob controlled from oven  
 Booster function  
 2 Ø 160 mm 1400 W / Boost 1800 W  
 induction element  
 2 Ø 200 mm 2100 W / Boost 2500 W  
 induction element  
 Pot detection  
 Child lock  
 Hot surface indicator

Timer  
 Slim design ceran glass serigraphy

### OPTIONAL FEATURES

Full inox frame

## VCH.02

### STANDARD FEATURES

60 cm ceramic hob  
 Combination with oven  
 2 Ø 145 mm Highlite Element 1200W  
 Hot surface indicator light

### OPTIONAL FEATURES

Ø 180 mm Dual Highlite Element  
 700W/1700W  
 Ø 145 mm Oval Highlite Element  
 1000W/1800W  
 Bevelled edge glass

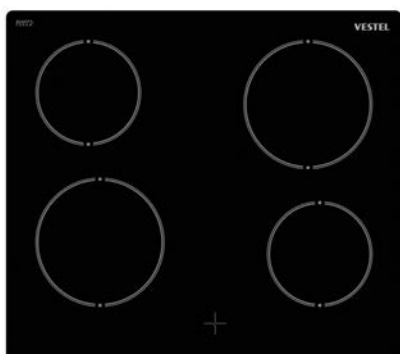
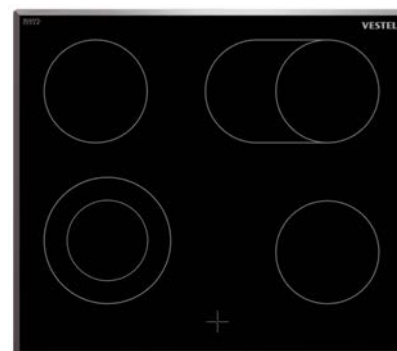

## VCH.03

### STANDARD FEATURES

60 cm ceramic hob  
 Combination with oven  
 2 Ø 145 mm Highlite Element 1200W  
 2 Ø 180 mm Highlite Element 1800W  
 Hot surface indicator light



## BGOGH.44

### STANDARD FEATURES

- 90 cm gas on glass hob
- 5 gas burners
- High efficiency wok burner
- Front knob control
- Flame safety device
- Cast iron pan supports
- Cast iron burner caps
- Mat enamel burner pans

### OPTIONAL FEATURES

- Dual work burner
- Cast iron high efficiency wok adapter
- Main switch
- White optical glass
- Inox burner pans
- Metal clad knobs
- One touch ignition

## BGOGH.17

### STANDARD FEATURES

- 70 cm gas on glass hob
- Plus X Design
- 5 gas burners
- Wok burner
- Front knob control
- Flame safety device

### OPTIONAL FEATURES

- Mat enamel burner pans
- Mat enamel burner caps
- Cast iron pan supports
- Metal clad knobs
- One touch ignition



## BGOGH.28

### STANDARD FEATURES

- 70 cm gas on glass hob
- Plus X Design
- 5 gas burners
- Wok burner
- Front knob control
- Flame safety device

### OPTIONAL FEATURES

- Mat enamel burner pans
- Mat enamel burner caps
- Cast iron pan supports
- Metal clad knobs
- One touch ignition



## BGOGH.29

### STANDARD FEATURES

70 cm gas on glass hob  
Plus X Design  
5 gas burners  
Wok burner  
Front knob control  
Flame safety device

### OPTIONAL FEATURES

White optical glass  
Inox burner pans  
Mat enamel burner caps  
Cast iron pan supports  
(line design)  
Metal clad knobs  
One touch ignition

## BGOGH.30

### STANDARD FEATURES

70 cm gas on glass hob  
Plus X Design  
5 gas burners  
Wok burner  
Front knob control  
Flame safety device

### OPTIONAL FEATURES

Mirror glass  
Inox burner pans  
Mat enamel burner caps  
Cast iron pan supports  
(deluxe design)  
Metal clad knobs  
One touch ignition



## BGOGH.31

### STANDARD FEATURES

70 cm gas on glass hob  
Plus X Design  
5 gas burners  
Wok burner  
Front knob control  
Flame safety device

### OPTIONAL FEATURES

Mat enamel burner pans  
Cast iron burner caps  
Cast iron pan supports  
(deluxe design)  
Metal clad knobs  
One touch ignition



## BGOGH.07

### STANDARD FEATURES

70 cm gas on glass hob  
5 gas burners  
Front knob control

### OPTIONAL FEATURES

Wok burner  
Mirror glass  
Inox burner pans  
Stainless steel frame  
Cast iron pan supports  
Cast iron burner caps  
One touch ignition  
Flame safety device  
Metal cladded knobs

## BGOGH.20

### STANDARD FEATURES

60 cm gas on glass hob  
Plus X Design  
4 gas burners  
Front knob control  
Flame safety device

### OPTIONAL FEATURES

Mat enamel burner pans  
Mat enamel burner caps  
Cast iron pan supports  
(line design)  
Metal cladded knobs  
One touch ignition



## BGOGH.32

### STANDARD FEATURES

60 cm gas on glass hob  
Plus X Design  
4 gas burners  
Front knob control  
Flame safety device

### OPTIONAL FEATURES

Wok burner  
Mat enamel burner pans  
Mat enamel burner caps  
Cast iron pan supports  
(line design)  
Metal cladded knobs  
One touch ignition



## BGOGH.19

### STANDARD FEATURES

60 cm gas on glass hob  
Plus X Design  
4 gas burners  
Front knob control  
Flame safety device

### OPTIONAL FEATURES

Mat enamel burner pans  
Cast iron burner caps  
Cast iron pan supports  
Metal clad knobs  
One touch ignition

## BGOGH.33

### STANDARD FEATURES

60 cm gas on glass hob  
Plus X Design  
4 gas burners  
Front knob control  
Flame safety device

### OPTIONAL FEATURES

Mirror glass  
Inox burner pans  
Mat enamel burner caps  
Cast iron pan supports  
Metal clad knobs  
One touch ignition



## BGOGH.34

### STANDARD FEATURES

60 cm gas on glass hob  
Plus X Design  
4 gas burners  
Front knob control  
Flame safety device

### OPTIONAL FEATURES

Mirror glass  
Wok burner  
Inox burner pans  
Mat enamel burner caps  
Cast iron pan supports  
(deluxe design)  
Metal clad knobs  
One touch ignition





## BGOGH.35

### STANDARD FEATURES

60 cm gas on glass hob  
Plus X Design  
4 gas burners  
Front knob control  
Flame safety device

### OPTIONAL FEATURES

White optical glass  
Wok burner  
Inox burner pans  
Mat enamel burner caps  
Cast iron pan supports  
Metal cladded knobs  
One touch ignition

## BGOGH.36

### STANDARD FEATURES

60 cm gas on glass hob  
Plus X Design  
4 gas burners  
Front knob control  
Flame safety device

### OPTIONAL FEATURES

White optical glass  
Inox burner pans  
Mat enamel burner caps  
Cast iron pan supports  
Metal cladded knobs  
One touch ignition



## BGOGH.18

### STANDARD FEATURES

60 cm gas on glass hob  
Plus X Design  
Front knob control  
Flame safety device  
Enamel burner pans  
Enamel burner caps  
Enamel pan supports

### OPTIONAL FEATURES

Metal cladded knobs  
One touch ignition  
3 gas burners and 145 mm hotplate



## BGOGH.21

### STANDARD FEATURES

60 cm gas on glass hob  
 Plus X Design  
 4 gas burners  
 Front knob control  
 Flame safety device

### OPTIONAL FEATURES

Mat enamel burner pans  
 Mat enamel burner caps  
 Cast iron pan supports  
 Metal clad knobs  
 One touch ignition

## BGOGH.09

### STANDARD FEATURES

60 cm gas on glass hob  
 4 gas burners  
 Front knob control  
 Black glass  
 Enamel burner pans  
 Enamel pan supports  
 Enamel burner caps

### OPTIONAL FEATURES

One touch ignition  
 Flame safety device  
 Inox frame



## BGOGH.37

### STANDARD FEATURES

60 cm gas on glass hob  
 4 gas burners  
 Front knob control  
 Enamel pan supports  
 Enamel burner caps  
 Flame safety device

### OPTIONAL FEATURES

Mirror glass  
 Inox burner pans  
 One touch ignition  
 Inox frame





## BGOGH.24

### STANDARD FEATURES

Pure Design  
 60 cm gas on glass and induction hob  
 Side knob control and Side touch control  
 2 gas burners  
 Enamel burner pans, pan supports and burner caps  
 Flame safety device  
 Booster function  
 Ø 160 mm 1400 W / Boost 1800 W induction element  
 Ø 200 mm 2100 W / Boost 2500 W

induction element  
 Pot detection and Automatic heat up  
 Child lock and Hot surface indicator  
 Key Lock  
 Timer

### OPTIONAL FEATURES

Metal clad knobs  
 One touch ignition

## BGOGH.38

### STANDARD FEATURES

60 cm gas on glass and induction hob  
 - Pure design  
 Side knob control and side touch control  
 2 gas burners - Flame safety device  
 Ø 160 mm 1400 W / Boost 1800 W induction element  
 Ø 200 mm 2100 W / Boost 2500 W induction element  
 Pot detection  
 Child lock  
 Hot surface indicator

Touch control interface for induction zones  
 Key Lock  
 Timer

### OPTIONAL FEATURES

Mat enamel burner pans and caps  
 Cast iron pan supports  
 Metal clad knobs  
 Full inox frame  
 One touch ignition

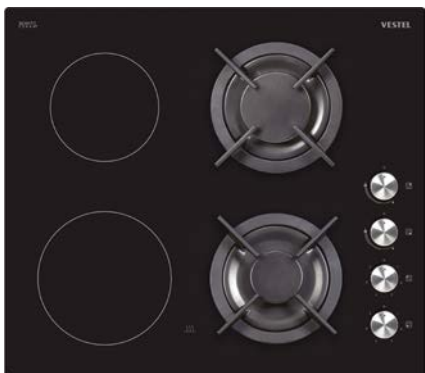

## BGOGH.25

### STANDARD FEATURES

60cm gas on glass and vitroceramic hob  
 Pure design  
 Side knob control  
 2 gas burners  
 Flame safety device  
 Ø 145 mm Highlite Element 1200W  
 Ø 180 mm Highlite Element 1800W  
 Hot surface indicator

### OPTIONAL FEATURES

Mat enamel burner pans  
 Mat enamel burner caps  
 Cast iron pan supports  
 Metal clad knobs  
 Full inox frame  
 One touch ignition

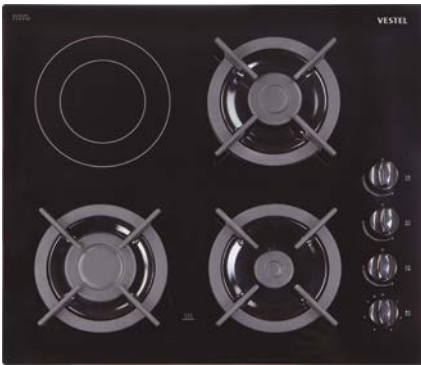

## BGOGH.23

### STANDARD FEATURES

Pure Design  
60 cm gas on glass and vitroceramic hob  
Side knob control  
3 gas burners  
Enamel burner pans  
Flame safety device  
Hot surface indicator

### OPTIONAL FEATURES

Cast iron pan supports  
Cast iron burner caps  
Ø 180 mm Dual Highlite Element  
700W/1700W  
One touch ignition

## BGOGH.40

### STANDARD FEATURES

60 cm gas on glass and vitroceramic hob  
Pure design  
Side knob control  
2 gas burners  
Enamel burner pans  
Enamel pan supports  
Enamel burner pans  
Flame safety device  
Hot surface indicator  
Ø 145 mm Highlite Element 1200W  
Ø 180 mm Highlite Element 1800W

### OPTIONAL FEATURES

Full inox frame  
One touch ignition



## BGOGH.39

### STANDARD FEATURES

60 cm gas on glass and vitroceramic hob  
Pure design - Side knob control  
3 gas burners  
Flame safety device  
Ø 180 mm Highlite Element 1800W  
Hot surface indicator

### OPTIONAL FEATURES

Mat enamel burner pans and caps  
Cast iron pan supports  
Metal clad knobs  
Full inox frame  
One touch ignition



## BGOGH.43

### STANDARD FEATURES

- 60 cm gas on glass hob
- Division design
- 4 gas burners
- Front knob control
- Flame safety device
- Cast iron pan supports
- Enamel burner caps
- Enamel burner caps

### OPTIONAL FEATURES

- Metal clad knobs
- One touch ignition

## BGOGH.41

### STANDARD FEATURES

- 60 cm gas on glass hob
- 3 gas burners
- Wok burner
- Side knob control
- Flame safety device

### OPTIONAL FEATURES

- Mat enamel burner pans
- Mat enamel burner caps
- Mat enamel pan supports
- One touch ignition



## BGOGH.05

### STANDARD FEATURES

- 60 cm gas on glass hob
- 4 gas burners
- Side knob control
- Black Glass
- Enamel burner pans
- Flame safety device

### OPTIONAL FEATURES

- Wok burner
- Cast iron burner caps
- Cast iron pan supports
- One touch ignition



## BGOGH.11

### STANDARD FEATURES

60 cm gas on glass hob  
4 gas burners  
Side knob control  
Enamel burner caps  
Enamel pan supports  
Flame safety device

### OPTIONAL FEATURES

Inox burner pans  
Inox colored optical glass  
Metal clad knobs  
One touch ignition

## BGOGH.26

### STANDARD FEATURES

60 cm gas on glass hob  
4 gas burners  
Side knob control  
Flame safety device

### OPTIONAL FEATURES

Mat enamel burner caps  
Mat enamel pan supports  
Mat enamel burner pans  
White optical glass  
One touch ignition



## BGOGH.13

### STANDARD FEATURES

60 cm gas on glass hob  
4 gas burners  
Side knob control

### OPTIONAL FEATURES

Wok burner  
Mirror glass  
Inox burner pans  
Cast iron pan supports  
Cast iron burner caps  
One touch ignition  
Flame safety device  
Metal clad knobs





## BGOGH.16

### STANDARD FEATURES

- 60 cm gas on glass hob
- 4 gas burners
- Side knob control
- Black glass
- Enamel pan supports
- Enamel burner caps
- Inox burner pans

### OPTIONAL FEATURES

- One touch ignition
- Flame safety device
- Metal cladded knobs
- Inox burner pans

## BGOGH.01

### STANDARD FEATURES

- 60 cm gas on glass hob
- 4 gas burners
- Side knob control
- Enamel burner caps
- Enamel pan supports
- Enamel burner pans
- Flame safety device

### OPTIONAL FEATURES

- Metal cladded knobs
- One touch ignition

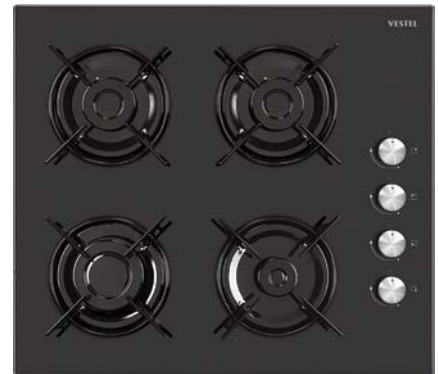

## BGOGH.42

### STANDARD FEATURES

- 60 cm gas on glass hob
- 4 gas burners
- Side knob control
- Enamel burner caps
- Enamel pan supports
- Flame safety device

### OPTIONAL FEATURES

- Inox burner pans
- White optical glass
- Metal cladded knobs
- One touch ignition



## BGOGH.27 Rustic

### STANDARD FEATURES

60 cm gas on glass hob  
4 gas burners  
Side knob control  
Flame safety device  
Enamel burner caps  
Enamel pan supports  
Enamel burner pans

### OPTIONAL FEATURES

Type-C Rustic design black optical glass  
One touch ignition  
Flame safety device  
Special rustic knobs

## BGOGH.12 Rustic

### STANDARD FEATURES

60 cm gas on glass hob  
4 gas burners  
Side knob control  
Flame safety device  
Enamel burner caps  
Enamel pan supports  
Enamel burner pans

### OPTIONAL FEATURES

Type-C Rustic design cream optical glass  
One touch ignition  
Flame safety device  
Special rustic knobs



## BGOGH.15 Rustic

### STANDARD FEATURES

60 cm gas on glass hob  
4 gas burners  
Side knob control  
Flame safety device  
Enamel burner caps  
Enamel pan supports  
Enamel burner pans

### OPTIONAL FEATURES

Type-B Rustic design white optical glass  
One touch ignition  
Flame safety device  
Special rustic knobs





## BGH.44

### STANDARD FEATURES

- 70 cm gas hob
- Plus X Design
- 5 gas burners
- Wok burner
- Front knob control
- Flame safety device

### OPTIONAL FEATURES

- Stainless steel
- Glass control panel
- Mat enamel burner caps
- Cast iron pan supports
- Metal clad knobs - Wok adaptor
- One touch ignition

## BGH.45

### STANDARD FEATURES

- 70 cm gas hob
- Plus X Design
- 5 gas burners
- Wok burner
- Front knob control
- Enamel pan supports
- Enamel burner pans
- Flame safety device

### OPTIONAL FEATURES

- Stainless steel
- Inox painted knobs
- Wok adaptor
- One touch ignition



## BGH.46

### STANDARD FEATURES

- 70 cm gas hob
- Plus X Design
- 5 gas burners
- Wok burner
- Front knob control
- Flame safety device

### OPTIONAL FEATURES

- Stainless steel
- Mat enamel burner caps
- Cast iron pan supports
- Inox painted knobs
- One touch ignition



## BGH.47

### STANDARD FEATURES

60 cm gas hob  
 Plus X Design  
 4 gas burners  
 Front knob control  
 Flame safety device

### OPTIONAL FEATURES

Stainless steel  
 Wok burner  
 Mat enamel burner caps  
 Cast iron pan supports  
 Glass control panel  
 Metal clad knobs  
 One touch ignition

## BGH.48

### STANDARD FEATURES

60 cm gas hob  
 Plus X Design  
 4 gas burners  
 Front knob control  
 Flame safety device

### OPTIONAL FEATURES

Stainless steel  
 Cast iron burner caps  
 Cast iron pan supports  
 Glass control panel  
 Metal clad knobs  
 One touch ignition



## BGH.49

### STANDARD FEATURES

60 cm gas hob  
 Plus X Design  
 4 gas burners  
 Front knob control  
 Enamel pan supports  
 Enamel burner pans  
 Flame safety device

### OPTIONAL FEATURES

Stainless steel  
 Glass control panel  
 Metal clad knobs  
 One touch ignition



## BGH.50

### STANDARD FEATURES

60 cm gas hob  
 Plus X Design  
 4 gas burners  
 Front knob control  
 Enamel pan supports  
 Enamel burner pans  
 Flame safety device

### OPTIONAL FEATURES

Metal clad knobs  
 One touch ignition

## BGH.51

### STANDARD FEATURES

60 cm gas hob  
 Plus X Design  
 4 gas burners  
 Front knob control  
 Enamel pan supports  
 Enamel burner caps  
 Flame safety device

### OPTIONAL FEATURES

Stainless steel  
 Metal clad knobs  
 One touch ignition



## BGH.52

### STANDARD FEATURES

60 cm gas hob  
 Division design  
 4 gas burners  
 Front knob control  
 Flame safety device  
 Cast iron pan supports  
 Mat enamel burner caps  
 Stainless steel hob

### OPTIONAL FEATURES

Metal clad knobs  
 One touch ignition







## BGH.56

### STANDARD FEATURES

- 70cm gas hob
- 5 gas burners
- Front knob control

### OPTIONAL FEATURES

- Stainless steel hob
- Wok burner
- Cast iron pan supports
- Cast iron burner caps
- One touch ignition
- Flame Safety device

## BGH.18

### STANDARD FEATURES

- 70 cm gas hob
- 5 gas burners
- Front knob control
- White enamel hob
- Enamel pan supports
- Enamel burner caps

### OPTIONAL FEATURES

- Wok burner
- Button ignition
- Flame safety device
- Enamel wok adapter



## BGH.38

### STANDARD FEATURES

- 70 cm gas hob
- 5 gas burners
- Front knob control
- Enamel pan supports
- Enamel burner caps

### OPTIONAL FEATURES

- Stainless steel hob
- Button ignition
- Flame safety device





## BGH.19

### STANDARD FEATURES

- 70 cm mixed hob
- 4 gas burners
- 145 mm hotplate
- Front knob control

### OPTIONAL FEATURES

- Black enamel hob
- 1 electric hotplate
- Cast iron pan supports
- Cast iron burner caps
- One touch ignition
- Flame safety device

## BGH.27

### STANDARD FEATURES

- 60 cm gas hob
- 4 gas burners
- Front knob control
- Enamel burner caps
- Enamel pan support
- Flame safety device

### OPTIONAL FEATURES

- One touch ignition
- Stainless steel hob



## BGH.26

### STANDARD FEATURES

- 60 cm gas hob
- 4 gas burners
- Front knob control
- White enamel hob
- Enamel burner caps
- Enamel pan support

### OPTIONAL FEATURES

- One touch ignition
- Flame safety device



## BGH.55

### STANDARD FEATURES

60 cm gas hob  
4 gas burners  
Front knob control  
Enamel pan supports  
Enamel burner caps  
Flame safety device

### OPTIONAL FEATURES

One touch ignition  
Metal clad knobs

## BGH.25

### STANDARD FEATURES

60 cm gas hob  
4 gas burners  
Front knob control

### OPTIONAL FEATURES

Stainless steel hob  
Wok burner  
Cast iron burner caps  
Cast iron pan supports  
One touch ignition  
Flame safety device



## BGH.34

### STANDARD FEATURES

60 cm gas hob  
4 gas burners  
Front knob control  
Enamel pan supports  
Enamel burner caps

### OPTIONAL FEATURES

Black enamel hob  
One touch ignition  
Flame safety device  
Metal clad knobs



## BGH.29

### STANDARD FEATURES

- 60 cm gas hob
- Surface design
- 4 gas burners
- Side knob control
- Enamel pan supports
- Enamel burner caps
- Flame safety device

### OPTIONAL FEATURES

- Stainless steel hob
- One touch ignition

## BGH.02

### STANDARD FEATURES

- 60 cm gas hob
- Surface design
- 3 gas burners
- Ø 180mm hotplate
- Side knob control
- Flame safety device

### OPTIONAL FEATURES

- Stainless steel hob
- One touch ignition
- Cast iron pan supports
- Cast iron burner caps
- Metal clad knobs



## BGH.03

### STANDARD FEATURES

- 60 cm mixed hob
- 3 gas burners
- 180 mm hotplate
- Side knob control
- Enamel pan supports
- Enamel burner caps

### OPTIONAL FEATURES

- Stainless steel hob
- Electric hotplate
- One touch ignition
- Flame safety device



## BGH.05

### STANDARD FEATURES

60 cm gas hob  
Surface design  
4 gas burners  
Side knob control  
Enamel pan supports  
Enamel burner caps  
Flame safety device  
White enamel hob

### OPTIONAL FEATURES

One touch ignition

## BGH.07

### STANDARD FEATURES

60 cm gas hob  
Surface design  
3 gas burners  
Ø 180mm hotplate  
Side knob control  
Enamel pan supports  
Enamel burner caps  
Flame safety device  
White enamel hob

### OPTIONAL FEATURES

One touch ignition



## BGH.08

### STANDARD FEATURES

60 cm gas hob  
White enamel hob  
4 gas burners  
Side knob control  
Enamel pan supports  
Enamel burner caps

### OPTIONAL FEATURES

One touch ignition  
Flame safety device



## BGH.09

### STANDARD FEATURES

- 60 cm gas hob
- Surface design
- 4 gas burners
- Side knob control
- Flame safety device

### OPTIONAL FEATURES

- Stainless steel hob
- One touch ignition
- Wok burner
- Cast iron pan supports
- Cast iron burner caps

## BGH.10

### STANDARD FEATURES

- 60 cm gas hob
- Surface design
- 3 gas burners
- Ø 180mm hotplate
- Side knob control
- Flame safety device

### OPTIONAL FEATURES

- One touch ignition
- Black enamel hob
- Cast iron pan supports
- Cast iron burner caps
- Mat black knobs



## BGH.01

### STANDARD FEATURES

- 60 cm gas hob
- Surface design
- 4 gas burners
- Side knob control
- Flame safety device

### OPTIONAL FEATURES

- Stainless steel hob
- One touch ignition
- Metal clad knobs
- Cast iron pan supports
- Cast iron burner caps



## BGH.43

### STANDARD FEATURES

60 cm gas hob  
 Extenda design  
 4 gas burners  
 Side knob control  
 Flame safety device

### OPTIONAL FEATURES

Stainless steel  
 Cast iron burner caps  
 Cast iron pan supports  
 One touch ignition  
 Metal clad knobs

## BGH.53

### STANDARD FEATURES

60 cm mixed hob  
 Smootline design  
 3 gas burners  
 Ø 180 mm hotplate  
 Side knob control  
 Enamel pan supports  
 Enamel burner camps  
 Flame safety device

### OPTIONAL FEATURES

One touch ignition



## BGH.54

### STANDARD FEATURES

60 cm gas hob  
 Smootline design  
 4 gas burners  
 Side knob control  
 Enamel pan supports  
 Enamel burner caps  
 Flame safety device

### OPTIONAL FEATURES

Black enamelled hob  
 One touch ignition





## BGH.40

### STANDARD FEATURES

- Smoothline design
- 60 cm gas hob
- 4 gas burners
- Side Knob control
- Enamel pan supports
- Enamel burner caps

### OPTIONAL FEATURES

- Stainless steel hob
- Button ignition
- Flame safety device
- Metal clad knobs

## BGH.39

### STANDARD FEATURES

- Smoothline design
- 60 cm gas hob
- 4 gas burners
- Side Knob control
- Enamel pan supports
- Enamel burner caps
- White enamel hob

### OPTIONAL FEATURES

- One touch ignition
- Flame safety device



## BGH.41

### STANDARD FEATURES

- Smoothline design
- 60 cm gas hob
- 4 gas burners
- Side Knob control
- Enamel pan supports
- Enamel burner caps

### OPTIONAL FEATURES

- TDF enamel hob
- One touch ignition
- Flame safety device
- Black knobs





## BGH.30 Rustic

### STANDARD FEATURES

60 cm gas hob  
Surface design  
4 gas burners  
Side knob control  
Flame safety device  
Enamel pan supports  
Enamel burner caps

### OPTIONAL FEATURES

Type-A Rustic design  
Special rustic knobs  
One touch ignition  
Black enamel hob

## BGH.31 Rustic

### STANDARD FEATURES

60 cm gas hob  
Surface design  
4 gas burners  
Side knob control  
Flame safety device  
Enamel pan supports  
Enamel burner caps  
White enamel hob

### OPTIONAL FEATURES

Type-A Rustic design  
One touch ignition



## BGH.28 Rustic

### STANDARD FEATURES

60 cm gas hob  
Surface design  
4 gas burners  
Side knob control  
Flame safety device

### OPTIONAL FEATURES

Type-B Rustic design  
Special rustic knobs  
One touch ignition  
Black enamel hob  
Cast iron pan supports  
Cast iron burner caps





## BEH.01

### STANDARD FEATURES

60cm electric hob  
Surface design  
4 solid hotplates  
(2x145mm)+(2x180mm)  
Side knob control

### OPTIONAL FEATURES

Stainless steel hob  
Black knobs

## BEH.02

### STANDARD FEATURES

60cm electric hob  
Surface design  
4 solid hotplates  
(2x145mm)+(2x180mm)  
Side knob control

### OPTIONAL FEATURES

Black enamel hob  
Inox painted knobs



## BEH.05

### STANDARD FEATURES

60cm electric hob  
Surface design  
4 solid hotplates  
(2x145mm)+(2x180mm)  
Side knob control

### OPTIONAL FEATURES

Stainless steel hob



## BCH.01

### FEATURES

60 cm electrical combi hob  
 White enamel hob  
 Combination with oven  
 4 solid hotplates  
 (2x145mm) + (2x180mm)

## BCH.02

### FEATURES

60 cm electrical combi hob  
 Black enamel hob  
 Combination with oven  
 4 solid hotplates  
 (2x145mm) + (2x180mm)



## BCH.03

### STANDARD FEATURES

60 cm electrical combi hob  
 Combination with oven  
 4 solid hotplates (2x145mm) +  
 (2x180mm)

### OPTIONAL FEATURES

1 Rapid hotplate  
 Stainless steel hob





## DVHS2.02 Domino Series 2

### STANDARD FEATURES

30 cm ceramic hob  
 Domino series 2 design  
 Front touch control  
 Ø 145 mm Highlite Element 1200W  
 700W/1700W  
 Hot surface indicator

### OPTIONAL FEATURES

Ø 180 mm Dual Highlite Element  
 Timer

## DVHS2.01 Domino Series 2

### STANDARD FEATURES

30 cm ceramic hob  
 Domino series 2 design  
 Front knob control  
 Ø 145 mm Highlite Element 1200W  
 700W/1700W  
 Hot surface indicator light

### OPTIONAL FEATURES

Ø 180 mm Dual Highlite Element  
 Metal clad knobs

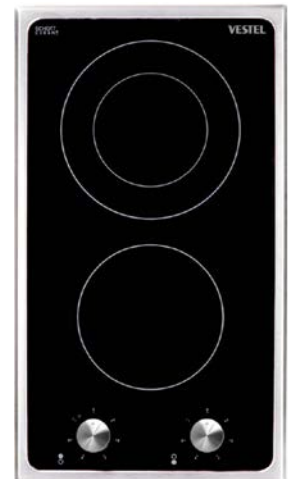

## DEHS2.02 Domino Series 2

### STANDARD FEATURES

30 cm electric hob  
 Domino series 2 design  
 Front knob control  
 Ø 145 mm solid hotplate  
 Ø 180 mm rapid hotplate

### OPTIONAL FEATURES

Metal clad knobs  
 Mechanical timer  
 1 rapid zone



## DEHS2.01 Domino Series 2

### STANDARD FEATURES

30 cm electric hob  
 Domino series 2 design  
 Front knob control  
 Ø 145 mm solid hotplate  
 Ø 180 mm rapid hotplate

### OPTIONAL FEATURES

Metal clad knobs  
 1 rapid zone

## DGHS2.01 Domino Series 2

### STANDARD FEATURES

30 cm gas on glass hob  
 Domino series 2 design  
 Black glass  
 2 gas burners  
 Flame safety device

### OPTIONAL FEATURES

Cast iron pan supports  
 Cast iron burner caps  
 Inox burner pans  
 One touch ignition  
 Metal clad knobs



## DGHS2.04 Domino Series 2

### STANDARD FEATURES

30 cm gas hob  
 Domino series 2 design  
 Stainless steel hob  
 2 gas burners  
 Flame safety device

### OPTIONAL FEATURES

Cast iron pan supports  
 Cast iron burner caps  
 One touch ignition  
 Metal clad knobs





## DGHS2.03 Domino Series 2

### STANDARD FEATURES

- 30 cm gas on glass hob
- Domino series 2 design
- Black glass
- 2 gas burners
- Enamel pan supports
- Enamel burner caps
- Flame safety device

### OPTIONAL FEATURES

- Inox burner pans
- One touch ignition
- Metal clad knobs

## DGHS2.06 Domino Series 2

### STANDARD FEATURES

- 30 cm gas hob
- Domino series 2 design
- Stainless steel hob
- 2 gas burners
- Enamel pan supports
- Enamel burner caps
- Flame safety device

### OPTIONAL FEATURES

- Button ignition



## DGHS2.02 Domino Series 2

### STANDARD FEATURES

- 30 cm gas on glass hob
- Domino series 2 design
- Black glass
- Wok burner
- Flame safety device

### OPTIONAL FEATURES

- Metal enamel burner pan
- Cast iron pan support
- Cast iron burner caps
- One touch ignition
- Metal clad knobs



## DGHS2.05 Domino Series 2

### STANDARD FEATURES

30 cm gas hob  
Domino series 2 design  
Stainless steel hob  
Wok burner  
Flame safety device  
Metal knob

### OPTIONAL FEATURES

Mat enamel pan support  
Mat enamel burner pan  
One touch ignition

## DIHS1.01 Domino Series 1

### STANDARD FEATURES

30 cm induction hob  
Front touch control  
Booster function  
Ø 160 mm 1400 W / Boost 1800 W  
induction element  
Ø 200 mm 2100 W / Boost 2500 W  
induction element  
Pot detection  
Automatic heat up  
Child lock  
Hot surface indicator

### OPTIONAL FEATURES

Timer

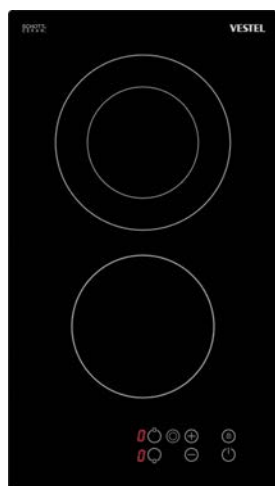
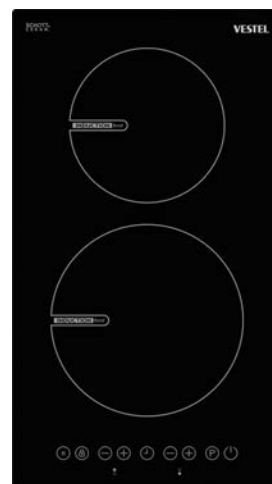

## DVHS1.03 Domino Series 1

### STANDARD FEATURES

30 cm ceramic hob  
Front touch control  
Ø 145 mm Highlite Element 1200W  
700W/1700W  
Child lock  
Hot surface indicator  
Key lock  
Smart Pause

### OPTIONAL FEATURES

Ø 180 mm Dual Highlite Element

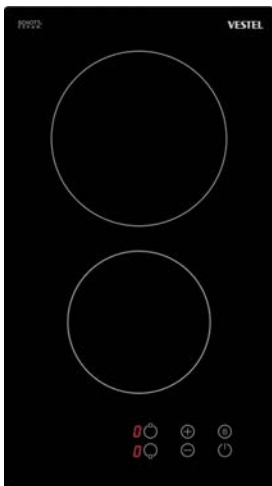

## DVHS1.05 Domino Series 1

### STANDARD FEATURES

30 cm ceramic hob  
Front touch control  
Ø 145 mm Highlite Element 1200W  
Ø 180 mm Highlite Element 1800W  
Child lock  
Hot surface indicator

## DVHS1.01 Domino Series 1

### STANDARD FEATURES

30 cm ceramic hob  
Front knob control  
Ø 145 mm Highlite Element 1200W  
Ø 180 mm Highlite Element 1800W  
Hot surface indicator light

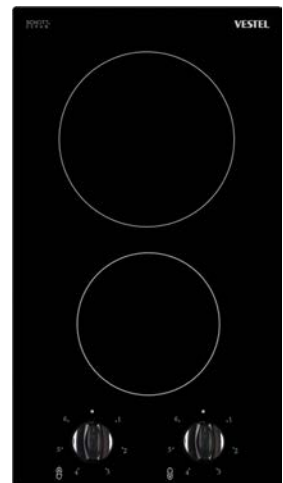

## DGHS1.03 Domino Series 1

### STANDARD FEATURES

30 cm gas on glass hob  
Domino series 1 design  
Black glass  
2 gas burners  
Flame safety device

### OPTIONAL FEATURES

Cast iron pan supports  
Cast iron burner caps  
Inox burner pans  
One touch ignition



## DGHS1.04 Domino Series 1

### STANDARD FEATURES

30 cm gas on glass hob  
Domino series 1 design  
Black glass  
Wok burner  
Flame safety device

### OPTIONAL FEATURES

Mat enamel pan support  
Mat enamel burner pan  
Inox burner pan  
One touch ignition

## DGHS1.01 Domino Series 1

### STANDARD FEATURES

30 cm gas on glass hob  
Domino series 1 design  
Black glass  
2 gas burners  
Enamel pan supports  
Enamel burner caps  
Enamel burner pans  
Flame safety device

### OPTIONAL FEATURES

One touch ignition



## DGHS1.02 Domino Series 1

### STANDARD FEATURES

30 cm gas on glass hob  
Domino series 1 design  
Black glass  
2 gas burners  
Enamel burner pans  
Flame safety device

### OPTIONAL FEATURES

Cast iron pan supports  
Cast iron burner caps  
One touch ignition



TABLE TOP HOB SPECIFICATIONS

| BUILT-IN / TABLE-TOP<br>HOB SPECIFICATION SHEET    | TT Gas/ Comnined/ Gas Securit Hobs |                          |                          |                          | TT Electric Hobs |                          |                          |                          |
|--|------------------------------------|--------------------------|--------------------------|--------------------------|------------------|--------------------------|--------------------------|--------------------------|
|  | 60 CM                              | 60 CM                    | 60 CM                    | 60 CM                    | 60 CM            | 60 CM                    | 60 CM                    |                          |
|  | Flat / Surface                     | Smoothline               | New Gen.                 | PlusX                    | Flat / Surface   | Smoothline               | New Gen.                 |                          |
| Available Colours                                  |                                    |                          |                          |                          |                  |                          |                          |                          |
| White  |                                    | Standard                 | Standard                 | Standard                 | Optional         | Standard                 | Standard                 | Standard                 |
| Brown  |                                    | Optional                 | Optional                 | -                        | Optional         | Optional                 | Optional                 | -                        |
| Terre de France                                    |                                    | Optional                 | Optional                 | -                        | Optional         | Optional                 | Optional                 | -                        |
| Black  |                                    | Optional                 | Optional                 | Optional                 | Standard         | Optional                 | Optional                 | Optional                 |
| Dark Green   |                                    | Optional                 | Optional                 | -                        | Optional         | Optional                 | Optional                 | -                        |
| Stainless Steel                                    |                                    | Optional                 | Optional                 | Optional                 | Optional         | Optional                 | Optional                 | Optional                 |
| Product Dimensions                                 |                                    |                          |                          |                          |                  |                          |                          |                          |
| Height (max.,varies from model to model)           | mm                                 | 95,5 - 104,5             | 95,5 - 104,5             | 95,5 - 104,5             | 104              | 56,5 - 104,5             | 56,5 - 104,5             | 56,5 - 104,5             |
| Width  | mm                                 | 585                      | 585                      | 580                      | 597              | 585                      | 585                      | 585                      |
| Depth (max., do not include gas connection detail) | mm                                 | 540                      | 540                      | 540                      | 526              | 540                      | 540                      | 540                      |
| Hob Features                                       |                                    |                          |                          |                          |                  |                          |                          |                          |
| Hob  |                                    | Enamel / Stainless Steel | Enamel / Stainless Steel | Enamel / Stainless Steel | Securit          | Enamel / Stainless Steel | Enamel / Stainless Steel | Enamel / Stainless Steel |
| Rapid Gas Burner Ø10cm                             | W                                  | 3000                     | 3000                     | 3000                     | 3000             | -                        | -                        | -                        |
| Semi-rapid Gas Burner Ø7.5cm                       | W                                  | 1750                     | 1750                     | 1750                     | 1750             | -                        | -                        | -                        |
| Auxiliary Gas Burner Ø5.5cm                        | W                                  | 1000                     | 1000                     | 1000                     | 1000             | -                        | -                        | -                        |
| Wok (Triple Flame) Gas Burner Mono Ø14cm           | W                                  | 3800                     | 3600                     | 3600                     | 3600             | -                        | -                        | -                        |
| Wok (Triple Flame) Gas Burner Dual Ø14cm           | W                                  | -                        | -                        | -                        | -                | -                        | -                        | -                        |
| Wok (Triple Flame) Gas Burner Ø11cm                | W                                  | -                        | -                        | -                        | -                | -                        | -                        | -                        |
| Ø 145 mm Hotplate                                  | W                                  | -                        | 1000                     | -                        | 1000             | 1000                     | 1000                     | 1000                     |
| Ø 180 mm Hotplate                                  | W                                  | 1500                     | -                        | 1500                     | -                | 1500                     | 1500                     | 1500                     |
| Ø 145 mm Rapid Hotplate                            | W                                  | -                        | 1500                     | -                        | -                | 1500                     | 1500                     | 1500                     |
| Ø 180 mm Rapid Hotplate                            | W                                  | 2000                     | -                        | 2000                     | -                | 2000                     | 2000                     | 2000                     |
| Hotplate Operation Indicator Light                 |                                    | Standard                 | Standard                 | Standard                 | Standard         | Standard                 | Standard                 | Standard                 |
| Side Knob Control                                  |                                    | Standard                 | Standard                 | Standard                 | -                | Standard                 | Standard                 | Standard                 |
| Front Knob Control                                 |                                    | -                        | -                        | -                        | Standard         | -                        | -                        | -                        |
| Bevelled Edges                                     |                                    | -                        | -                        | -                        | -                | -                        | -                        | -                        |
| Logo   |                                    | Standard                 | Standard                 | Standard                 | Standard         | Standard                 | Standard                 | Standard                 |
| Special Decoration on Glass                        |                                    | -                        | -                        | -                        | -                | -                        | -                        | -                        |
| Stainless Steel Burner Pan                         |                                    | -                        | -                        | -                        | -                | -                        | -                        | -                        |
| Table Top Installation (not built-in)              |                                    | Standard                 | Standard                 | Standard                 | Standard         | Standard                 | Standard                 | Standard                 |
| Glass Lid  |                                    | Optional                 | Optional                 | Optional                 | -                | Optional                 | Optional                 | Optional                 |
| Burner Safety Valves                               |                                    | Standard                 | Standard                 | Standard                 | Standard         | -                        | -                        | -                        |
| Button Ignition                                    |                                    | Optional                 | Optional                 | Optional                 | Optional         | -                        | -                        | -                        |
| One-touch-Ignition through knobs                   |                                    | Optional                 | Optional                 | Optional                 | Optional         | -                        | -                        | -                        |
| Enamel Pan Supports                                |                                    | Standard                 | Standard                 | Standard                 | Standard         | -                        | -                        | -                        |
| Cast Iron Pan Supports                             |                                    | Optional                 | Optional                 | Optional                 | Optional         | -                        | -                        | -                        |
| Cast Iron Burner Caps                              |                                    | Optional                 | Optional                 | Optional                 | Optional         | -                        | -                        | -                        |
| Coffee Adaptor                                     |                                    | Optional                 | Optional                 | Optional                 | Optional         | -                        | -                        | -                        |
| Wok Adaptor  |                                    | Optional                 | Optional                 | Optional                 | Optional         | -                        | -                        | -                        |
| Gas Conversion Kit                                 |                                    | Standard                 | Standard                 | Standard                 | Standard         | -                        | -                        | -                        |
| Others   |                                    |                          |                          |                          |                  |                          |                          |                          |
| Total Gas Power (Depends on Model) Maximum         | kW                                 | 8,3                      | 8,1                      | 8,1                      | 8,1              | -                        | -                        | -                        |
| Total Electric Power (Depends on Model) Maximum    | kW                                 | -                        | -                        | -                        | 1                | 6                        | 6                        | 6                        |
| Voltage  | V                                  | 230V~                    | 230V~                    | 230V~                    | 230V~            | 230 / 400V 3N~           | 230 / 400V 3N~           | 230 / 400V 3N~           |
| RoHS Compliance                                    |                                    | Standard                 | Standard                 | Standard                 | Standard         | Standard                 | Standard                 | Standard                 |
| CE Compliance                                      |                                    | Standard                 | Standard                 | Standard                 | Standard         | Standard                 | Standard                 | Standard                 |
| Carton Box Packaging                               |                                    | Standard                 | Standard                 | Standard                 | Standard         | Standard                 | Standard                 | Standard                 |
| Packed Product Dimensions (WxDxH)                  | mm                                 | 643 x 645 x 132          | 643 x 645 x 132          | x                        | x                | 643 x 645 x 132          | 643 x 645 x 132          | x                        |
| Packed Product Dimensions (WxDxH) Box              | mm                                 | 662 x 648 x 140          | 662 x 648 x 140          | 662 x 648 x 140          | 645 x 648 x 140  | 662 x 648 x 140          | 662 x 648 x 140          | 662 x 648 x 140          |
| Net Weight (Depends on Model) Maximum              | kg                                 | 13                       | 13                       | 14                       | 15               | 13,5                     | 13,5                     | 14,5                     |
| Gross Weight (Depends on Model) Maximum            | kg                                 | 14.25                    | 14.25                    | 15                       | 16               | 14.75                    | 14.75                    | 15,5                     |

Table Top Hob Designs



New Generation Gas On Glass Design



New Generation Design



Standard Design

Table Top Hob Aesthetics



New Generation Gas On Glass Table Top Hob Aesthetic



New Generation Table Top Hob Aesthetic



Standard Design "S-Type" Table Top Hob Aesthetic



Standard Design "R-Type" Table Top Hob Aesthetic



Standard Design "Smootline" Table Top Hob Aesthetic



Standard Design "Surface" Table Top Hob Aesthetic

Table Top Frame Color



White Painted



Black Painted



Inox Painted



Silver Painted



Stainless Steel  
only available for gas on glass table top hob





## TTGGH-S2.01

### STANDARD FEATURES

- 60cm gas on glass table top hob
- 4 gas burners
- Front knob control
- Enamel burner pan
- Enamel burner caps and pan supports
- Flame Safety Device

### OPTIONAL FEATURES

- White optical glass cooktop
- White table top frame
- One touch ignition
- Inox clad knobs

## TTGGH-S2.02

### STANDARD FEATURES

- 60cm gas on glass table top hob
- 3 gas burners and 145mm hotplate
- Front knob control
- Black glass cooktop
- Black table top frame
- Enamel burner pan supports
- Flame Safety Device

### OPTIONAL FEATURES

- Cast Iron burner caps
- Cast Iron pan supports
- One touch ignition
- Stainless steel table top frame
- Inox clad knobs



## TTGGH-S2.03



### STANDARD FEATURES

- 60cm gas on glass table top hob
- 4 gas burners
- Front knob control
- Black glass cooktop
- Black table top frame
- Enamel burner pan supports
- Flame Safety Device

### OPTIONAL FEATURES

- Wok Burner
- Cast Iron burner caps
- Cast Iron pan supports
- One touch ignition
- Inox clad knobs



## TTGH-S2.01

### STANDARD FEATURES

60 cm table top gas hob  
New generation table top hob design  
4 gas burners  
Side knob control  
Enamel cooktop  
Enamel burner pan supports  
Flame Safety Device

### OPTIONAL FEATURES

One touch ignition

## TTEH-S2.01

### STANDARD FEATURES

60 cm table top electric hob  
New generation table top hob design  
4 solid hotplates  
(2x145mm)+(2x180mm)  
Side knob control  
Enamel cooktop

### OPTIONAL FEATURES

Rapid Hotplates (145mm and  
180 mm)



## TTGH-S2.02

### STANDARD FEATURES

60 cm table top gas hob  
New generation table top hob design  
4 gas burners  
Side knob control  
Flame Safety Device

### OPTIONAL FEATURES

Stainless steel cooktop  
Wok Burner  
One touch ignition  
Cast iron pan support  
Cast iron burner caps  
Glass cover lid  
Inox painted knobs

## TTGH-S1.01



### STANDARD FEATURES

- 60 cm table top gas hob
- Standard type table top hob design
- Flat R-type cooktop aesthetics
- 3 gas burners
- Ø180mm hotplate
- Side knob control
- Enamel pan supports and burner caps
- Flame Safety Device

### OPTIONAL FEATURES

- Stainless steel cooktop
- Inox painted table top frame
- One touch ignition
- Black Knobs

## TTEH-S1.02

### STANDARD FEATURES

- 60 cm table top electrical hob
- Standard type table top hob design
- Flat S-type cooktop aesthetics
- 4 solid hotplates
- (2x145mm)+(2x180mm)
- Side knob control

### OPTIONAL FEATURES

- Stainless steel cooktop
- Inox clad knobs
- Inox painted table top frame



## TTGH-S1.02



### STANDARD FEATURES

- 60 cm table top gas hob
- Standard type table top hob design
- Smoothline cooktop aesthetics
- 3 gas burners
- Ø145mm hotplate
- Side knob control
- Enamel cooktop
- Enamel burner pan supports
- Flame Safety Device

### OPTIONAL FEATURES

- One touch ignition
- Inox painted knobs

## TTGH-S1.03



### STANDARD FEATURES

60 cm table top gas hob  
 Standard type table top hob design  
 Smoothline cooktop aesthetics  
 4 gas burners  
 Side knob control  
 Enamel burner caps and pan supports  
 Flame Safety Device

### OPTIONAL FEATURES

Stainless steel cooktop  
 One touch ignition  
 Inox painted knobs  
 Inox painted table top frame

## TTGH-S1.04

### STANDARD FEATURES

60 cm table top gas hob  
 Standard type table top hob design  
 Flat R-type cooktop aesthetics  
 4 gas burners  
 Side knob control  
 Enamel cooktop  
 Enamel burner caps and pan supports  
 Flame Safety Device

### OPTIONAL FEATURES

One touch ignition  
 Glass lid



## TTGH-S1.05



### STANDARD FEATURES

60 cm table top gas hob  
 Standard type table top hob design  
 Surface cooktop aesthetics  
 4 gas burners  
 Side knob control  
 Flame Safety Device

### OPTIONAL FEATURES

Stainless steel cooktop  
 Wok Burner  
 Cast Iron burner caps and pan supports  
 One touch ignition  
 Inox painted table top frame  
 Glass lid  
 Black knobs

REFRIGERATORS//SPECIFICATIONS

| BUILT IN   |                  |                    |                    |                    |                    |                    |                    |                    |              |                  |                    |                    |
|--|------------------|--------------------|--------------------|--------------------|--------------------|--------------------|--------------------|--------------------|--------------|------------------|--------------------|--------------------|
| Model  | 3200             |                    | 3200 TURBO         | 2610               |                    | 2400               |                    | 2500               |              | 1800             |                    |                    |
| Refrigerator Class   | 7                |                    | 7                  | 7                  |                    | 7                  |                    | 1                  |              | 7                |                    |                    |
| Climatic Class   | BGN (16 °C-32°C) |                    | BGT/N (16 °C-43°C) | BGN (16 °C-32°C)   |                    | BGN (16 °C-32°C)   |                    | BGN (16 °C-32°C)   |              | BGN (16 °C-32°C) |                    |                    |
| Energy Class   | A+               | A                  | B                  | A+                 | A++                | A++                | A+                 | A++                | A+           | A++              | A+                 |                    |
| Volume Total (gross)                                       | lt               | 276                | 276                | 276                | 217                | 217                | 195                | 195                | 206          | 206              | 153                | 153                |
| Volume Total (net)   | lt               | 261                | 261                | 260                | 214                | 214                | 192                | 192                | 204          | 204              | 150                | 150                |
| Volume refrigerator (gross)                                | lt               | 192                | 192                | 192                | 179                | 179                | 178                | 178                | 206          | 206              | 136                | 136                |
| Volume refrigerator (net)                                  | lt               | 189                | 189                | 188                | 176                | 176                | 175                | 175                | 204          | 204              | 133                | 133                |
| Chiller Volume (net)                                       | lt               | -                  | -                  | -                  | -                  | -                  | -                  | -                  | -            | -                | -                  | -                  |
| Volume Freezer (gross)                                     | lt               | 84                 | 84                 | 84                 | 38                 | 38                 | 17                 | 17                 | 0            | 0                | 17                 | 17                 |
| Volume Freezer (net)                                       | lt               | 72                 | 72                 | 72                 | 38                 | 38                 | 17                 | 17                 | 0            | 0                | 17                 | 17                 |
| Performance (star rating)                                  |                  | 4                  | 4                  | 4                  | 4                  | 4                  | 4                  | 4                  | -            | -                | 4                  | 4                  |
| Energy consumption   | kWh/24h          | 0,715              | 0,936              | 1,408              | 0,622              | 0,488              | 0,450              | 0,573              | 0,272        | 0,346            | 0,414              | 0,529              |
| Energy consumption   | kWh/year         | 261                | 342                | 514                | 227                | 178                | 164                | 209                | 99           | 126              | 151                | 193                |
| Freezing Capacity  | kg/24h           | 4                  | 5                  | 4                  | 2                  | 2                  | 2                  | 2                  | -            | -                | 2                  | 2                  |
| Temperature Rise Time (-18°C to -9°C)                      | mins             | 660                | 660                | 550                | 960                | 960                | 664                | 664                | -            | -                | 720                | 720                |
| Noise Emission   | dB (A)           | 41                 | 41                 | 42                 | 42                 | 42                 | 43                 | 42                 | 41           | 39               | 41                 | 41                 |
| Defrost System Type Frigde/Freezer                         |                  | Automatic / Manual | Automatic / Manual | Automatic / Manual | Automatic / Manual | Automatic / Manual | Automatic / Manual | Automatic / Manual | Automatic    | Automatic        | Automatic / Manual | Automatic / Manual |
| Built in   |                  | YES                | YES                | YES                | YES                | YES                | YES                | YES                | YES          | YES              | YES                | YES                |
| Product dimensions (WxDxH)                                 | mm               | 540x545x1770       | 540x545x1770       | 540x545x1770       | 540x545x1445       | 540x545x1445       | 540x545x1225       | 540x545x1225       | 540x545x1225 | 540x545x1225     | 540x545x1020       | 540x545x1020       |
| Packaged dims (WxDxH) (double-wave carton pack) / standard | mm               | 584x600x1834       | 584x600x1834       | 584x600x1834       | 584x600x1509       | 584x600x1509       | 584x600x1289       | 584x600x1289       | 584x600x1289 | 584x600x1289     | 584x600x1084       | 584x600x1084       |
| Loading Quantity / 40ft HC                                 | pcs              | 100                | 100                | 100                | 133                | 133                | 160                | 160                | 160          | 160              | 160                | 160                |
| Refrigerating Gas  |                  | R600a              | R600a              | R600a              | R600a              | R600a              | R600a              | R600a              | R600a        | R600a            | R600a              | R600a              |

| BUILT IN   |                  |                    |                  |                    |                    |                   |                     |                     |                   |             |                   |             |             |
|--|------------------|--------------------|------------------|--------------------|--------------------|-------------------|---------------------|---------------------|-------------------|-------------|-------------------|-------------|-------------|
| Model  | 1900             |                    | 1400             |                    | 1500               |                   | 1450                |                     | 1700              |             | 1650              |             |             |
| Refrigerator Class   | 1                |                    | 7                |                    | 1                  |                   | 8                   |                     | 1                 |             | 8                 |             |             |
| Climatic Class   | BGN (16 °C-32°C) | BGT/N (16 °C-43°C) | BGN (16 °C-32°C) |                    | BGN (16°C-32°C)    | BGT/N (16°C-43°C) | BGT/SN (10 °C-43°C) | BGST/N (16 °C-38°C) | BGSN (10 °C-32°C) |             | BGSN (10 °C-32°C) |             |             |
| Energy Class   | A++              | A+                 | A++              | A+                 | A++                | A+                | A++                 | A+                  | A++               | A+          | A+                | A           |             |
| Volume Total (gross)                                       | lt               | 162                | 162              | 126                | 126                | 135               | 135                 | 109                 | 109               | 136         | 136               | 107         | 107         |
| Volume Total (net)   | lt               | 160                | 160              | 123                | 123                | 134               | 134                 | 99                  | 99                | 133         | 133               | 93          | 93          |
| Volume refrigerator (gross)                                | lt               | 162                | 162              | 109                | 109                | 135               | 135                 | 0                   | 0                 | 136         | 136               | 0           | 0           |
| Volume refrigerator (net)                                  | lt               | 160                | 160              | 106                | 106                | 134               | 134                 | 0                   | 0                 | 133         | 133               | 0           | 0           |
| Chiller Volume (net)                                       | lt               | -                  | -                | -                  | -                  | -                 | -                   | -                   | -                 | -           | -                 | -           | -           |
| Volume Freezer (gross)                                     | lt               | 0                  | 0                | 17                 | 17                 | 0                 | 0                   | 109                 | 109               | 0           | 0                 | 107         | 107         |
| Volume Freezer (net)                                       | lt               | 0                  | 0                | 17                 | 17                 | 0                 | 0                   | 99                  | 99                | 0           | 0                 | 93          | 93          |
| Performance (star rating)                                  |                  | -                  | -                | 4                  | 4                  | -                 | -                   | 4                   | 4                 | -           | -                 | 4           | 4           |
| Energy consumption   | kWh/24h          | 0,261              | 0,343            | 0,392              | 0,499              | 0,255             | 0,332               | 0,433               | 0,534             | 0,247       | 0,316             | 0,484       | 0,635       |
| Energy consumption   | kWh/year         | 95                 | 125              | 143                | 182                | 93                | 121                 | 158                 | 195               | 90          | 115               | 177         | 232         |
| Freezing Capacity  | kg/24h           | -                  | -                | 2                  | 2                  | -                 | -                   | 8                   | 8                 | -           | -                 | 9           | 9           |
| Temperature Rise Time (-18°C to -9°C)                      | mins             | -                  | -                | 650                | 650                | -                 | -                   | 660                 | 660               | -           | -                 | 1080        | 1080        |
| Noise Emission   | dB (A)           | 41                 | 39               | 41                 | 41                 | 39                | 41                  | 40                  | 39                | 44          | 44                | 44          | 44          |
| Defrost System Type Frigde/Freezer                         |                  | Automatic          | Automatic        | Automatic / Manual | Automatic / Manual | Automatic         | Automatic           | Manual              | Manual            | Automatic   | Automatic         | Manual      | Manual      |
| Built in   |                  | YES                | YES              | YES                | YES                | YES               | YES                 | YES                 | YES               | YES         | YES               | YES         | YES         |
| Product dimensions (WxDxH)                                 | mm               | 540x545x1020       | 540x545x1020     | 540x545x875        | 540x545x875        | 540x545x875       | 540x545x875         | 540x545x875         | 540x545x875       | 595x548x818 | 595x548x818       | 595x548x818 | 595x548x818 |
| Packaged dims (WxDxH) (double-wave carton pack) / standard | mm               | 584x600x1084       | 584x600x1084     | 584x600x939        | 584x600x939        | 584x600x939       | 584x600x939         | 584x600x939         | 584x600x939       | 659x586x883 | 659x586x883       | 659x586x883 | 659x586x883 |
| Loading Quantity / 40ft HC                                 | pcs              | 160                | 160              | 205                | 205                | 205               | 205                 | 205                 | 205               | 214         | 214               | 214         | 214         |
| Refrigerating Gas  |                  | R600a              | R600a            | R600a              | R600a              | R600a             | R600a               | R600a               | R600a             | R600a       | R600a             | R600a       | R600a       |

| <b>BUILT IN</b>  |                 |                  |                  |              |                    |                  |                   |              |                   |                     |              |                     |              |                     |              |  |
|--|-----------------|------------------|------------------|--------------|--------------------|------------------|-------------------|--------------|-------------------|---------------------|--------------|---------------------|--------------|---------------------|--------------|--|
| Model  | <b>3320</b>     |                  |                  |              | <b>3310</b>        |                  |                   |              | <b>1600</b>       |                     | <b>2791E</b> |                     | <b>2795E</b> |                     | <b>2795M</b> |  |
| Refrigerator Class   | 7               |                  |                  |              | 7                  |                  |                   |              | 7                 | 8                   |              | 1                   |              | 1                   |              |  |
| Climatic Class   | BGN (16°C-32°C) |                  |                  |              | BGT/SN (10°C-43°C) |                  | BGT/N (16°C-43°C) |              | BGSN (10 °C-32°C) | BGT/SN (10 °C-43°C) |              | BGT/SN (10 °C-43°C) |              | BGT/SN (10 °C-43°C) |              |  |
| Energy Class   | A++             | A+               | A++              | A+           | A++                | A+               | A+                | A+           | A++               | A+                  | A++          | A+                  | A++          | A+                  |              |  |
| Volume Total (gross)                                       | lt              | 235              | 235              | 235          | 235                | 235              | 235               | 120          | 221               | 221                 | 303          | 303                 | 303          | 303                 |              |  |
| Volume Total (net)   | lt              | 223              | 223              | 216          | 216                | 216              | 216               | 115          | 197               | 197                 | 300          | 300                 | 300          | 300                 |              |  |
| Volume refrigerator (gross)                                | lt              | 160              | 160              | 160          | 160                | 160              | 160               | 102          | 0                 | 0                   | 303          | 303                 | 303          | 303                 |              |  |
| Volume refrigerator (net)                                  | lt              | 158              | 158              | 158          | 158                | 158              | 158               | 98           | 0                 | 0                   | 300          | 300                 | 300          | 300                 |              |  |
| Chiller Volume (net)                                       | lt              | -                | -                | -            | -                  | -                | -                 | -            | ---               | ---                 | ---          | ---                 | ---          | ---                 |              |  |
| Volume Freezer (gross)                                     | lt              | 75               | 75               | 75           | 75                 | 75               | 75                | 18           | 221               | 221                 | -            | -                   | -            | -                   |              |  |
| Volume Freezer (net)                                       | lt              | 65               | 65               | 58           | 58                 | 58               | 58                | 17           | 197               | 197                 | -            | -                   | -            | -                   |              |  |
| Performance (star rating)                                  |                 | 4                | 4                | 4            | 4                  | 4                | 4                 | 4            | 4*                | 4*                  | ---          | ---                 | ---          | ---                 |              |  |
| Energy consumption   | kWh/24h         | 0,523            | 0,665            | 0,584        | 0,743              | 0,468            | 0,638             | 0,813        | 0,309             | 0,397               | 0,309        | 0,397               | 0,309        | 0,397               |              |  |
| Energy consumption   | kWh/year        | 191              | 243              | 213          | 271                | 171              | 233               | 297          | 113               | 145                 | 113          | 145                 | 113          | 145                 |              |  |
| Freezing Capacity  | kg/24h          | 3                | 3                | 2,6          | 2,6                | 2                | 9                 | 9            | ---               | ---                 | ---          | ---                 | ---          | ---                 |              |  |
| Temperature Rise Time (-18°C to -9°C)                      | mins            | 1140             | 1140             | 750          | 750                | 626              | TBD               | 540          | -                 | -                   | -            | -                   | -            | -                   |              |  |
| Noise Emission   | dB (A)          | 41               | 41               | 43           | 43                 | 44               | TBD               | TBD          | TBD               | TBD                 | TBD          | TBD                 | TBD          | TBD                 |              |  |
| Defrost System Type Frigde/Freezer                         |                 | Automatic/Manuel | Automatic/Manuel | Automatic    | Automatic          | Automatic/Manuel | Automatic         | Automatic    | Manual            | Manual              | Manual       | Manual              | Manual       | Manual              |              |  |
| Built in   |                 | YES              | YES              | YES          | YES                | YES              | YES               | YES          | YES               | YES                 | YES          | YES                 | YES          | YES                 |              |  |
| Product dimensions (WxDxH)                                 | mm              | 540x545x1770     | 540x545x1770     | 540x545x1770 | 540x545x1770       | 595x548x818      | 540x545x1770      | 540x545x1770 | 540x545x1770      | 540x545x1770        | 540x545x1770 | 540x545x1770        | 540x545x1770 | 540x545x1770        |              |  |
| Packaged dims (WxDxH) (double-wave carton pack) / standard | mm              | 584x600x1834     | 584x600x1834     | 584x600x1834 | 584x600x1834       | 659x586x883      | 584x600x1834      | 584x600x1834 | 584x600x1834      | 584x600x1834        | 584x600x1834 | 584x600x1834        | 584x600x1834 | 584x600x1834        |              |  |
| Loading Quantity / 40ft HC                                 | pcs             | 100              | 100              | 100          | 100                | 214              | 100               | 100          | 100               | 100                 | 100          | 100                 | 100          | 100                 |              |  |
| Refrigerating Gas  |                 | R600a            | R600a            | R600a        | R600a              | R600a            | R600a             | R600a        | R600a             | R600a               | R600a        | R600a               | R600a        | R600a               |              |  |

| <b>BUILT IN</b>  |                  |              |              |              |                  |              |              |              |                  |                  |              |                  |              |                  |              |  |
|--|------------------|--------------|--------------|--------------|------------------|--------------|--------------|--------------|------------------|------------------|--------------|------------------|--------------|------------------|--------------|--|
| Model  | <b>2761M</b>     |              |              |              | <b>2761E</b>     |              |              |              | <b>2751M</b>     |                  | <b>2751E</b> |                  | <b>2750M</b> |                  | <b>2760M</b> |  |
| Refrigerator Class   | 7                |              |              |              | 7                |              |              |              | 7                | 7                |              | 7                |              | 7                |              |  |
| Climatic Class   | BGN (16 °C-32°C) |              |              |              | BGN (16 °C-32°C) |              |              |              | BGN (16 °C-32°C) | BGN (16 °C-32°C) |              | BGN (16 °C-32°C) |              | BGN (16 °C-32°C) |              |  |
| Energy Class   | A++              | A+           | A++          | A+           | A++              | A+           | A++          | A+           | A++              | A+               | A++          | A+               | A++          | A+               |              |  |
| Volume Total (gross)                                       | lt               | 251          | 251          | 251          | 251              | 245          | 245          | 245          | 245              | 245              | 245          | 245              | 251          | 251              |              |  |
| Volume Total (net)   | lt               | 237          | 237          | 237          | 237              | 227          | 227          | 227          | 227              | 235              | 235          | 235              | 243          | 243              |              |  |
| Volume refrigerator (gross)                                | lt               | 179          | 179          | 179          | 179              | 146          | 146          | 146          | 146              | 146              | 146          | 146              | 179          | 179              |              |  |
| Volume refrigerator (net)                                  | lt               | 179          | 179          | 179          | 179              | 146          | 146          | 146          | 146              | 146              | 146          | 146              | 179          | 179              |              |  |
| Chiller Volume (net)                                       | lt               | ---          | ---          | ---          | ---              | ---          | ---          | ---          | ---              | ---              | ---          | ---              | ---          | ---              |              |  |
| Volume Freezer (gross)                                     | lt               | 72           | 72           | 72           | 72               | 99           | 99           | 99           | 99               | 99               | 99           | 99               | 72           | 72               |              |  |
| Volume Freezer (net)                                       | lt               | 58           | 58           | 58           | 58               | 81           | 81           | 81           | 81               | 89               | 89           | 89               | 64           | 64               |              |  |
| Performance (star rating)                                  |                  | 4*           | 4*           | 4*           | 4*               | 4*           | 4*           | 4*           | 4*               | 4*               | 4*           | 4*               | 4*           | 4*               |              |  |
| Energy consumption   | kWh/24h          | 0,547        | 0,698        | 0,547        | 0,698            | 0,569        | 0,726        | 0,569        | 0,726            | 0,556            | 0,709        | 0,539            | 0,684        |                  |              |  |
| Energy consumption   | kWh/year         | 200          | 255          | 200          | 255              | 208          | 265          | 208          | 265              | 203              | 259          | 197              | 250          |                  |              |  |
| Freezing Capacity  | kg/24h           | 3            | 3            | 3            | 3                | 3            | 3            | 3            | 3                | 3                | 3            | 3                | 3            |                  |              |  |
| Temperature Rise Time (-18°C to -9°C)                      | mins             | TBD          | TBD          | TBD          | TBD              | TBD          | TBD          | TBD          | TBD              | TBD              | TBD          | TBD              | TBD          |                  |              |  |
| Noise Emission   | dB (A)           | TBD          | TBD          | TBD          | TBD              | TBD          | TBD          | TBD          | TBD              | TBD              | TBD          | TBD              | TBD          |                  |              |  |
| Defrost System Type Frigde/Freezer                         |                  | Automatic    | Automatic    | Automatic    | Automatic        | Automatic    | Automatic    | Automatic    | Automatic        | Automatic        | Automatic    | Automatic        | Automatic    |                  |              |  |
| Built in   |                  | YES          | YES          | YES          | YES              | YES          | YES          | YES          | YES              | YES              | YES          | YES              | YES          |                  |              |  |
| Product dimensions (WxDxH)                                 | mm               | 540x545x1770 | 540x545x1770 | 540x545x1770 | 540x545x1770     | 540x545x1770 | 540x545x1770 | 540x545x1770 | 540x545x1770     | 540x545x1770     | 540x545x1770 | 540x545x1770     | 540x545x1770 |                  |              |  |
| Packaged dims (WxDxH) (double-wave carton pack) / standard | mm               | 584x600x1834 | 584x600x1834 | 584x600x1834 | 584x600x1834     | 584x600x1834 | 584x600x1834 | 584x600x1834 | 584x600x1834     | 584x600x1834     | 584x600x1834 | 584x600x1834     | 584x600x1834 |                  |              |  |
| Loading Quantity / 40ft HC                                 | pcs              | 100          | 100          | 100          | 100              | 100          | 100          | 100          | 100              | 100              | 100          | 100              | 100          |                  |              |  |
| Refrigerating Gas  |                  | R600a        | R600a        | R600a        | R600a            | R600a        | R600a        | R600a        | R600a            | R600a            | R600a        | R600a            | R600a        |                  |              |  |



DISHWASHERS//SPECIFICATIONS

| SEMI-INTEGRATED X&C SERIES 60cm Models                                 | X11                           | X1A                           | X12                           | X1B                           | X13                           | X1C                           | X14                           | X1D                           |
|--|-------------------------------|-------------------------------|-------------------------------|-------------------------------|-------------------------------|-------------------------------|-------------------------------|-------------------------------|
| General Characteristics  |                               |                               |                               |                               |                               |                               |                               |                               |
| Number of Place Settings   | 12                            | 12                            | 12                            | 12                            | 12                            | 12                            | 12                            | 12                            |
| Number of programs   | 2                             | 2                             | 3                             | 3                             | 4                             | 4                             | 5                             | 5                             |
| Temperatures (°C)  | Temperatures (°C)             | Temperatures (°C)             | Temperatures (°C)             | Temperatures (°C)             | Temperatures (°C)             | Temperatures (°C)             | Temperatures (°C)             | Temperatures (°C)             |
| Control type   | full-electronic               | full-electronic               | full-electronic               | full-electronic               | full-electronic               | full-electronic               | full-electronic               | full-electronic               |
| Hidden heating element   | Yes                           | Yes                           | Yes                           | Yes                           | Yes                           | Yes                           | Yes                           | Yes                           |
| Filter type  | Metal / Plastic               | Metal / Plastic               | Metal / Plastic               | Metal / Plastic               | Metal / Plastic               | Metal / Plastic               | Metal / Plastic               | Metal / Plastic               |
| Turbidity sensor   | No                            | No                            | No                            | No                            | No                            | No                            | No                            | No                            |
| Drying system  | Mini Active/ Super Active     | Mini Active/ Super Active     | Mini Active/ Super Active     | Mini Active/ Super Active     | Mini Active/ Super Active     | Mini Active/ Super Active     | Mini Active/ Super Active     | Mini Active/ Super Active     |
| Overflow & leakage protection  | Yes                           | Yes                           | Yes                           | Yes                           | Yes                           | Yes                           | Yes                           | Yes                           |
| Heater protection  | Yes                           | Yes                           | Yes                           | Yes                           | Yes                           | Yes                           | Yes                           | Yes                           |
| Circulation Pump   | Asynchronous                  | Asynchronous                  | Asynchronous                  | Asynchronous                  | Asynchronous                  | Asynchronous                  | Asynchronous                  | Asynchronous                  |
| Programs   |                               |                               |                               |                               |                               |                               |                               |                               |
| Prewash  | No                            | No                            | No                            | No                            | No                            | No                            | No                            | No                            |
| Eco 50°C   | Yes                           | Yes                           | Yes                           | Yes                           | Yes                           | Yes                           | Yes                           | Yes                           |
| Intensive 65°C   | Yes                           | Yes                           | Yes                           | Yes                           | Yes                           | Yes                           | Yes                           | Yes                           |
| Quick 30' 40°C   | No                            | No                            | No                            | No                            | Yes                           | Yes                           | Yes                           | Yes                           |
| Super 50' 65°C   | No                            | No                            | Yes                           | Yes                           | Yes                           | Yes                           | Yes                           | Yes                           |
| Super 55' 60°C   | No                            | No                            | No                            | No                            | No                            | No                            | No                            | No                            |
| Delicate 40°C  | No                            | No                            | No                            | No                            | No                            | No                            | No                            | No                            |
| Normal 55°C  | No                            | No                            | No                            | No                            | No                            | No                            | No                            | No                            |
| Auto Delicate 30°C - 50°C  | No                            | No                            | No                            | No                            | No                            | No                            | No                            | No                            |
| Auto Normal 50°C - 60°C  | No                            | No                            | No                            | No                            | No                            | No                            | No                            | No                            |
| Auto Intensive 60°C - 70°C   | No                            | No                            | No                            | No                            | No                            | No                            | No                            | No                            |
| Hygiene 60°C   | No                            | No                            | No                            | No                            | No                            | No                            | No                            | No                            |
| Hygiene 70°C   | No                            | No                            | No                            | No                            | No                            | No                            | Yes                           | Yes                           |
| Extra Intensive 70°C (Prewash Button + Intensive 65°C)                 | No                            | No                            | No                            | No                            | No                            | No                            | No                            | No                            |
| Extra Hygiene 70°C (Prewash Button + Hygiene 60°C)                     | No                            | No                            | No                            | No                            | No                            | No                            | No                            | No                            |
| User Interface   |                               |                               |                               |                               |                               |                               |                               |                               |
| Start/Pause  | Yes                           | Yes                           | Yes                           | Yes                           | Yes                           | Yes                           | Yes                           | Yes                           |
| Prewash button   | No                            | No                            | No                            | No                            | No                            | No                            | No                            | No                            |
| DISPLAY (delay start (1-2-3...-19hr), remaining time)                  | No                            | Yes                           | No                            | Yes                           | No                            | Yes                           | No                            | Yes                           |
| Option button1 (Delay time)  | Yes (3hr, 6hr, 9hr)           | No                            | Yes (3hr, 6hr, 9hr)           | No                            | Yes (3hr, 6hr, 9hr)           | No                            | Yes (3hr, 6hr, 9hr)           | No                            |
| Option button1 (Half load with 1 mode)                                 | Yes                           | Yes                           | Yes                           | Yes                           | Yes                           | Yes                           | Yes                           | Yes                           |
| Half load button (with 3 modes)  | No                            | No                            | No                            | No                            | No                            | No                            | No                            | No                            |
| Tablet button  | No                            | No                            | No                            | No                            | No                            | No                            | No                            | No                            |
| Rinse-aid indicator  | Yes                           | Yes                           | Yes                           | Yes                           | Yes                           | Yes                           | Yes                           | Yes                           |
| Salt indicator   | Yes                           | Yes                           | Yes                           | Yes                           | Yes                           | Yes                           | Yes                           | Yes                           |
| Washing cycle indicators   | Yes                           | Yes                           | Yes                           | Yes                           | Yes                           | Yes                           | Yes                           | Yes                           |
| Child Lock   | No                            | Yes                           | No                            | Yes                           | No                            | Yes                           | No                            | Yes                           |
| Baskets & Accessories  |                               |                               |                               |                               |                               |                               |                               |                               |
| 3rd basket   | No                            | No                            | No                            | No                            | No                            | No                            | No                            | No                            |
| Upper basket types [mesh type / peg type]                              | (o)                           | (o)                           | (o)                           | (o)                           | (o)                           | (o)                           | (o)                           | (o)                           |
| Adjustable upper basket when empty                                     | (o)                           | (o)                           | (o)                           | (o)                           | (o)                           | (o)                           | (o)                           | (o)                           |
| Adjustable upper basket when loaded                                    | (o)                           | (o)                           | (o)                           | (o)                           | (o)                           | (o)                           | (o)                           | (o)                           |
| Number of mug shelves  | 2 (std) / 4 (o)               | 2 (std) / 4 (o)               | 2 (std) / 4 (o)               | 2 (std) / 4 (o)               | 2 (std) / 4 (o)               | 2 (std) / 4 (o)               | 2 (std) / 4 (o)               | 2 (std) / 4 (o)               |
| Adjustable mug shelves (peg)   | Yes                           | Yes                           | Yes                           | Yes                           | Yes                           | Yes                           | Yes                           | Yes                           |
| Adjustable mug shelves (mesh)  | (o)                           | (o)                           | (o)                           | (o)                           | (o)                           | (o)                           | (o)                           | (o)                           |
| Foldable racks on upper basket (peg)                                   | fixed (std) / 2 or 4 or 6 (o) | fixed (std) / 2 or 4 or 6 (o) | fixed (std) / 2 or 4 or 6 (o) | fixed (std) / 2 or 4 or 6 (o) | fixed (std) / 2 or 4 or 6 (o) | fixed (std) / 2 or 4 or 6 (o) | fixed (std) / 2 or 4 or 6 (o) | fixed (std) / 2 or 4 or 6 (o) |
| Foldable racks on lower basket   | (o)                           | (o)                           | (o)                           | (o)                           | (o)                           | (o)                           | (o)                           | (o)                           |
| Wire basket handles  | (o)                           | (o)                           | (o)                           | (o)                           | (o)                           | (o)                           | (o)                           | (o)                           |
| Plastic basket handles   | (o)                           | (o)                           | (o)                           | (o)                           | (o)                           | (o)                           | (o)                           | (o)                           |
| Removable cutlery basket (Single piece)                                | (o)                           | (o)                           | (o)                           | (o)                           | (o)                           | (o)                           | (o)                           | (o)                           |
| Removable cutlery basket (Universal)                                   | No                            | No                            | No                            | No                            | No                            | No                            | No                            | No                            |
| Removable cutlery basket (Modular) (2)                                 | (o)                           | (o)                           | (o)                           | (o)                           | (o)                           | (o)                           | (o)                           | (o)                           |
| Removable cutlery basket (Sliding) (3)                                 | (o)                           | (o)                           | (o)                           | (o)                           | (o)                           | (o)                           | (o)                           | (o)                           |
| Multi func. kit (Extra mug shelves + higher rear part on lower basket) | (o)                           | (o)                           | (o)                           | (o)                           | (o)                           | (o)                           | (o)                           | (o)                           |
| Bottle holder on lower basket  | (o)                           | (o)                           | (o)                           | (o)                           | (o)                           | (o)                           | (o)                           | (o)                           |
| Wine stem support & Spoon rack on upper basket (2)                     | (o)                           | (o)                           | (o)                           | (o)                           | (o)                           | (o)                           | (o)                           | (o)                           |
| Top nozzle   | No                            | No                            | No                            | No                            | No                            | No                            | No                            | No                            |
| Aquastop external hose   | (o)                           | (o)                           | (o)                           | (o)                           | (o)                           | (o)                           | (o)                           | (o)                           |
| Interior light   | No                            | No                            | No                            | No                            | No                            | No                            | No                            | No                            |
| Performance (4)  |                               |                               |                               |                               |                               |                               |                               |                               |
| Noise Level (dB(A))  | 57/54/52/49/47/45             | 57/54/52/49/47/45             | 57/54/52/49/47/45             | 57/54/52/49/47/45             | 57/54/52/49/47/45             | 57/54/52/49/47/45             | 57/54/52/49/47/45             | 57/54/52/49/47/45             |
| Energy efficiency class  | A++                           | A++                           | A++                           | A++                           | A++                           | A++                           | A++                           | A++                           |
| Cleaning performance   | A                             | A                             | A                             | A                             | A                             | A                             | A                             | A                             |
| Drying performance   | A                             | A                             | A                             | A                             | A                             | A                             | A                             | A                             |
| Water consumption (lt)   | 12                            | 12                            | 12                            | 12                            | 12                            | 12                            | 12                            | 12                            |
| Annual water consumption (lt/year)                                     | 3360                          | 3360                          | 3360                          | 3360                          | 3360                          | 3360                          | 3360                          | 3360                          |
| Program duration (min)   | 165                           | 165                           | 165                           | 165                           | 165                           | 165                           | 165                           | 165                           |
| Energy consumption (kWh)   | 0,90                          | 0,90                          | 0,90                          | 0,90                          | 0,90                          | 0,90                          | 0,90                          | 0,90                          |
| Annual energy consumption (kWh/year)                                   | 258                           | 258                           | 258                           | 258                           | 258                           | 258                           | 258                           | 258                           |
| Voltage (V) / Frequency (Hz)   | 220-240 / 50                  | 220-240 / 50                  | 220-240 / 50                  | 220-240 / 50                  | 220-240 / 50                  | 220-240 / 50                  | 220-240 / 50                  | 220-240 / 50                  |
| Fuse Rating (A)  | 10                            | 10                            | 10                            | 10                            | 10                            | 10                            | 10                            | 10                            |
| Dimensions   |                               |                               |                               |                               |                               |                               |                               |                               |
| Height (cm)  | 82,0                          | 82,0                          | 82,0                          | 82,0                          | 82,0                          | 82,0                          | 82,0                          | 82,0                          |
| Width (cm)   | 59,8                          | 59,8                          | 59,8                          | 59,8                          | 59,8                          | 59,8                          | 59,8                          | 59,8                          |
| Depth (cm)   | 57,0                          | 57,0                          | 57,0                          | 57,0                          | 57,0                          | 57,0                          | 57,0                          | 57,0                          |
| Height adjustment (+cm)  | 5                             | 5                             | 5                             | 5                             | 5                             | 5                             | 5                             | 5                             |
| Packed dimensions (Height x Width x Depth) (cm)                        | 85,1 x 64,4 x 66,1            | 85,1 x 64,4 x 66,1            | 85,1 x 64,4 x 66,1            | 85,1 x 64,4 x 66,1            | 85,1 x 64,4 x 66,1            | 85,1 x 64,4 x 66,1            | 85,1 x 64,4 x 66,1            | 85,1 x 64,4 x 66,1            |
| Stacking quantity (pcs)  | 5                             | 5                             | 5                             | 5                             | 5                             | 5                             | 5                             | 5                             |
| Gross/Net weight (kg/5)  | 43 /41                        | 43 /41                        | 43 /41                        | 43 /41                        | 43 /41                        | 43 /41                        | 43 /41                        | 43 /41                        |
| Container loading (40'HQ/ 40'/ 20')                                    | 162 /108 /54                  | 162 /108 /54                  | 162 /108 /54                  | 162 /108 /54                  | 162 /108 /54                  | 162 /108 /54                  | 162 /108 /54                  | 162 /108 /54                  |

| SEMI-INTEGRATED X&C SERIES 60cm Models                                 | X15                           | X1E                           | X16                           | X1F                           | C21                            | C31                                 | C41                            |
|--|-------------------------------|-------------------------------|-------------------------------|-------------------------------|--------------------------------|-------------------------------------|--------------------------------|
| General Characteristics  |                               |                               |                               |                               |                                |                                     |                                |
| Number of Place Settings   | 12                            | 12                            | 12                            | 12                            | 12                             | 12/13                               | 12/15                          |
| Number of programs   | 6                             | 6                             | 7                             | 7                             | 6                              | 7                                   | 9+                             |
| Temperatures (°C)  | Temperatures (°C)             | Temperatures (°C)             | Temperatures (°C)             | Temperatures (°C)             | Temperatures (°C)              | Temperatures (°C)                   | Temperatures (°C)              |
| Control type   | full-electronic               | full-electronic               | full-electronic               | full-electronic               | full-electronic                | full-electronic                     | full-electronic                |
| Hidden heating element   | Yes                           | Yes                           | Yes                           | Yes                           | Yes                            | Yes                                 | Yes                            |
| Filter type  | Metal / Plastic               | Metal / Plastic               | Metal / Plastic               | Metal / Plastic               | Metal / Plastic                | Metal / Plastic                     | Metal / Plastic                |
| Turbidity sensor   | No                            | No                            | No                            | No                            | No                             | No                                  | Yes                            |
| Drying system  | Mini Active/ Super Active     | Mini Active/ Super Active     | Mini Active/ Super Active     | Mini Active/ Super Active     | Mini Active/ Super Active      | Mini Active/ Super Active/ Turbo(1) | Super Active/ Turbo(1)         |
| Overflow & leakage protection  | Yes                           | Yes                           | Yes                           | Yes                           | Yes                            | Yes                                 | Yes                            |
| Heater protection  | Yes                           | Yes                           | Yes                           | Yes                           | Yes                            | Yes                                 | Yes                            |
| Circulation Pump   | Asynchronous                  | Asynchronous                  | Asynchronous                  | Asynchronous                  | Asynchronous                   | Asynchronous                        | Asynchronous                   |
| Programs   |                               |                               |                               |                               |                                |                                     |                                |
| Prewash  | Yes                           | Yes                           | Yes                           | Yes                           | Yes (separate function button) | Yes (separate function button)      | Yes (separate function button) |
| Eco 50°C   | Yes                           | Yes                           | Yes                           | Yes                           | Yes                            | Yes                                 | Yes                            |
| Intensive 65°C   | Yes                           | Yes                           | Yes                           | Yes                           | Yes                            | Yes                                 | No                             |
| Quick 30' 40°C   | Yes                           | Yes                           | Yes                           | Yes                           | Yes                            | Yes                                 | Yes                            |
| Super 50' 65°C   | Yes                           | Yes                           | Yes                           | Yes                           | Yes                            | Yes                                 | No                             |
| Super 55' 60°C   | No                            | No                            | No                            | No                            | No                             | No                                  | Yes                            |
| Delicate 40°C  | No                            | No                            | Yes                           | Yes                           | No                             | Yes                                 | No                             |
| Normal 55°C  | No                            | No                            | No                            | No                            | No                             | No                                  | No                             |
| Auto Delicate 30°C - 50°C  | No                            | No                            | No                            | No                            | No                             | No                                  | Yes                            |
| Auto Normal 50°C - 60°C  | No                            | No                            | No                            | No                            | No                             | No                                  | Yes                            |
| Auto Intensive 60°C - 70°C   | No                            | No                            | No                            | No                            | No                             | No                                  | Yes                            |
| Hygiene 60°C   | No                            | No                            | No                            | No                            | No                             | No                                  | Yes                            |
| Hygiene 70°C   | Yes                           | Yes                           | Yes                           | Yes                           | No                             | No                                  | No                             |
| Extra Intensive 70°C (Prewash Button + Intensive 65°C)                 | No                            | No                            | No                            | No                            | Yes                            | Yes                                 | No                             |
| Extra Hygiene 70°C (Prewash Button + Hygiene 60°C)                     | No                            | No                            | No                            | No                            | No                             | No                                  | Yes                            |
| User Interface   |                               |                               |                               |                               |                                |                                     |                                |
| Start/Pause  | Yes                           | Yes                           | Yes                           | Yes                           | Yes                            | Yes                                 | Yes                            |
| Prewash button   | No                            | No                            | No                            | No                            | Yes                            | Yes                                 | Yes                            |
| DISPLAY (delay start (1-2-3-...-19hr), remaining time)                 | No                            | Yes                           | No                            | Yes                           | No                             | No                                  | Yes                            |
| Option button1 (Delay time)  | Yes (3hr, 6hr, 9hr)           | No                            | Yes (3hr, 6hr, 9hr)           | No                            | Yes (3hr, 6hr, 9hr, 12hr)      | Yes (3hr, 6hr, 9hr, 12hr)           | No                             |
| Option button1 (Half load with 1 mode)                                 | Yes                           | Yes                           | Yes                           | Yes                           | No                             | No                                  | No                             |
| Half load button (with 3 modes)  | No                            | No                            | No                            | No                            | No                             | Yes                                 | Yes                            |
| Tablet button  | No                            | No                            | No                            | No                            | No                             | No                                  | Yes                            |
| Rinse-aid indicator  | Yes                           | Yes                           | Yes                           | Yes                           | Yes                            | Yes                                 | Yes                            |
| Salt indicator   | Yes                           | Yes                           | Yes                           | Yes                           | Yes                            | Yes                                 | Yes                            |
| Washing cycle indicators   | Yes                           | Yes                           | Yes                           | Yes                           | Yes                            | Yes                                 | Yes                            |
| Child Lock   | No                            | Yes                           | No                            | Yes                           | Yes                            | Yes                                 | Yes                            |
| Baskets & Accessories  |                               |                               |                               |                               |                                |                                     |                                |
| 3rd basket   | No                            | No                            | No                            | No                            | No                             | No(12ps), Yes (13ps)                | No(12ps), Yes (15ps)           |
| Upper basket types [mesh type / peg type]                              | (o)                           | (o)                           | (o)                           | (o)                           | (o)                            | (o)                                 | (o)                            |
| Adjustable upper basket when empty                                     | (o)                           | (o)                           | (o)                           | (o)                           | (o)                            | (o)                                 | (o)                            |
| Adjustable upper basket when loaded                                    | (o)                           | (o)                           | (o)                           | (o)                           | (o)                            | (o)                                 | (o)                            |
| Number of mug shelves  | 2 (std) / 4 (o)               | 2 (std) / 4 (o)               | 2 (std) / 4 (o)               | 2 (std) / 4 (o)               | 2 (std) / 4 (o)                | 2 (std) / 4 (o)                     | 2 (std) / 4 (o)                |
| Adjustable mug shelves (peg)   | Yes                           | Yes                           | Yes                           | Yes                           | Yes                            | Yes                                 | Yes                            |
| Adjustable mug shelves (mesh)  | (o)                           | (o)                           | (o)                           | (o)                           | (o)                            | (o)                                 | (o)                            |
| Foldable racks on upper basket (peg)                                   | fixed (std) / 2 or 4 or 6 (o) | fixed (std) / 2 or 4 or 6 (o) | fixed (std) / 2 or 4 or 6 (o) | fixed (std) / 2 or 4 or 6 (o) | fixed (std) / 2 or 4 or 6 (o)  | fixed (std) / 2 or 4 or 6 (o)       | fixed (std) / 2 or 4 or 6 (o)  |
| Foldable racks on lower basket   | (o)                           | (o)                           | (o)                           | (o)                           | (o)                            | (o)                                 | (o)                            |
| Wire basket handles  | (o)                           | (o)                           | (o)                           | (o)                           | (o)                            | (o)                                 | (o)                            |
| Plastic basket handles   | (o)                           | (o)                           | (o)                           | (o)                           | (o)                            | (o)                                 | (o)                            |
| Removable cutlery basket (Single piece)                                | (o)                           | (o)                           | (o)                           | (o)                           | (o)                            | (o)(12ps) / No(13ps)                | (o)(12ps) / No(15ps)           |
| Removable cutlery basket (Universal)                                   | No                            | No                            | No                            | No                            | No                             | No(12ps) / (o)(13ps)                | No(12ps) / (o)(15ps)           |
| Removable cutlery basket (Modular) (2)                                 | (o)                           | (o)                           | (o)                           | (o)                           | (o)                            | (o)                                 | (o)                            |
| Removable cutlery basket (Sliding) (3)                                 | (o)                           | (o)                           | (o)                           | (o)                           | (o)                            | (o)                                 | (o)(12ps) / No(15ps)           |
| Multi func. kit (Extra mug shelves + higher rear part on lower basket) | (o)                           | (o)                           | (o)                           | (o)                           | (o)                            | (o)                                 | (o)                            |
| Bottle holder on lower basket  | (o)                           | (o)                           | (o)                           | (o)                           | (o)                            | (o)                                 | (o)                            |
| Wine stem support & Spoon rack on upper basket (2)                     | (o)                           | (o)                           | (o)                           | (o)                           | (o)                            | (o)                                 | (o)                            |
| Top nozzle   | No                            | No                            | No                            | No                            | No                             | (o)(12ps) / Yes(13ps)               | (o)(12ps) / Yes(15ps)          |
| Aquastop external hose   | (o)                           | (o)                           | (o)                           | (o)                           | (o)                            | (o)                                 | (o)                            |
| Interior light   | No                            | No                            | No                            | No                            | No                             | No                                  | (o)                            |
| Performance (4)  |                               |                               |                               |                               |                                |                                     |                                |
| Noise Level (dB(A))  | 57/54/52/49/47/45             | 57/54/52/49/47/45             | 57/54/52/49/47/45             | 57/54/52/49/47/45             | 57/54/52/49/47/45              | 54/52/49/47/45                      | 54/52/49/47/45                 |
| Energy efficiency class  | A++                           | A++                           | A++                           | A++                           | A++                            | A++                                 | A++                            |
| Cleaning performance   | A                             | A                             | A                             | A                             | A                              | A                                   | A                              |
| Drying performance   | A                             | A                             | A                             | A                             | A                              | A                                   | A                              |
| Water consumption (lt)   | 12                            | 12                            | 12                            | 12                            | 12                             | 9                                   | 9                              |
| Annual water consumption (lt/year)                                     | 3360                          | 3360                          | 3360                          | 3360                          | 3360                           | 2520                                | 2520                           |
| Program duration (min)   | 165                           | 165                           | 165                           | 165                           | 165                            | 166                                 | 166                            |
| Energy consumption (kWh)   | 0,90                          | 0,90                          | 0,90                          | 0,90                          | 0,90                           | 0,90 / 0,91                         | 0,90 / 0,94                    |
| Annual energy consumption (kWh/year)                                   | 258                           | 258                           | 258                           | 258                           | 258                            | 258 / 261                           | 258 / 267                      |
| Voltage (V) / Frequency (Hz)   | 220-240 / 50                  | 220-240 / 50                  | 220-240 / 50                  | 220-240 / 50                  | 220-240 / 50                   | 220-240 / 50                        | 220-240 / 50                   |
| Fuse Rating (A)  | 10                            | 10                            | 10                            | 10                            | 10                             | 10                                  | 10                             |
| Dimensions   |                               |                               |                               |                               |                                |                                     |                                |
| Height (cm)  | 82,0                          | 82,0                          | 82,0                          | 82,0                          | 82,0                           | 82,0                                | 82,0                           |
| Width (cm)   | 59,8                          | 59,8                          | 59,8                          | 59,8                          | 59,8                           | 59,8                                | 59,8                           |
| Depth (cm)   | 57,0                          | 57,0                          | 57,0                          | 57,0                          | 57,0                           | 57,0                                | 57,0                           |
| Height adjustment (+cm)  | 5                             | 5                             | 5                             | 5                             | 5                              | 5                                   | 5                              |
| Packed dimensions (Height x Width x Depth) (cm)                        | 85,1 x 64,4 x 66,1            | 85,1 x 64,4 x 66,1            | 85,1 x 64,4 x 66,1            | 85,1 x 64,4 x 66,1            | 85,1 x 64,4 x 66,1             | 85,1 x 64,4 x 66,1                  | 85,1 x 64,4 x 66,1             |
| Stacking quantity (pcs)  | 5                             | 5                             | 5                             | 5                             | 5                              | 5                                   | 5                              |
| Gross/Net weight (kg/5)  | 43 /41                        | 43 /41                        | 43 /41                        | 43 /41                        | 43 /41                         | 43 /41                              | 43 /41                         |
| Container loading (40'HC/ 40' 20')                                     | 162 /108 /54                  | 162 /108 /54                  | 162 /108 /54                  | 162 /108 /54                  | 162 /108 /54                   | 162 /108 /54                        | 162 /108 /54                   |

Notes

- (o) : Optional
- (1) : Turbo fan drying system & 3rd basket are default for 15ps models & 13 ps for C31 model
- (2) : Modular cutlery basket for 12 PS must be selected with wine stem support & spoon rack. Also wine stem support & spoon rack can be selected only for mesh type upper basket option.
- (3) : Can be selected for lower basket with fixed type or with 4 foldable wire.
- (4) : Based on the tests performed with Eco 50°C program in accordance with EN 50242.
- (5) : Gros/Net Weights are shown as reference in the table. It should be calculated based on the final product features created from this general spect table.

# DISHWASHERS//SPECIFICATIONS

| SEMI-INTEGRATED Y SERIES 60cm Models                                   | Y11                           | Y1A                           | Y12                           | Y1B                           | Y13                           | Y1C                           | Y14                           | Y1D                           |
|--|-------------------------------|-------------------------------|-------------------------------|-------------------------------|-------------------------------|-------------------------------|-------------------------------|-------------------------------|
| General Characteristics  |                               |                               |                               |                               |                               |                               |                               |                               |
| Number of Place Settings   | 12                            | 12                            | 12                            | 12                            | 12                            | 12                            | 12                            | 12                            |
| Number of programs   | 2                             | 2                             | 3                             | 3                             | 4                             | 4                             | 5                             | 5                             |
| Temperatures (°C)  | 50-65                         | 50-65                         | 50-65                         | 50-65                         | 40-50-65                      | 40-50-65                      | 40-50-65-70                   | 40-50-65-70                   |
| Control type   | full-electronic               | full-electronic               | full-electronic               | full-electronic               | full-electronic               | full-electronic               | full-electronic               | full-electronic               |
| Hidden heating element   | Yes                           | Yes                           | Yes                           | Yes                           | Yes                           | Yes                           | Yes                           | Yes                           |
| Filter type  | Metal / Plastic               | Metal / Plastic               | Metal / Plastic               | Metal / Plastic               | Metal / Plastic               | Metal / Plastic               | Metal / Plastic               | Metal / Plastic               |
| Turbidity sensor   | No                            | No                            | No                            | No                            | No                            | No                            | No                            | No                            |
| Drying system  | Mini Active/ Super Active     | Mini Active/ Super Active     | Mini Active/ Super Active     | Mini Active/ Super Active     | Mini Active/ Super Active     | Mini Active/ Super Active     | Mini Active/ Super Active     | Mini Active/ Super Active     |
| Overflow & leakage protection  | Yes                           | Yes                           | Yes                           | Yes                           | Yes                           | Yes                           | Yes                           | Yes                           |
| Heater protection  | Yes                           | Yes                           | Yes                           | Yes                           | Yes                           | Yes                           | Yes                           | Yes                           |
| Circulation Pump   | Asynchronous                  | Asynchronous                  | Asynchronous                  | Asynchronous                  | Asynchronous                  | Asynchronous                  | Asynchronous                  | Asynchronous                  |
| Programs   |                               |                               |                               |                               |                               |                               |                               |                               |
| Prewash  | No                            | No                            | No                            | No                            | No                            | No                            | No                            | No                            |
| Eco  | Yes                           | Yes                           | Yes                           | Yes                           | Yes                           | Yes                           | Yes                           | Yes                           |
| Intensive 65°C   | Yes                           | Yes                           | Yes                           | Yes                           | Yes                           | Yes                           | Yes                           | Yes                           |
| Steam Wash   | No                            | No                            | No                            | No                            | No                            | No                            | No                            | No                            |
| Quick 30' 40°C   | No                            | No                            | No                            | No                            | Yes                           | Yes                           | Yes                           | Yes                           |
| Super 50' 65°C   | No                            | No                            | Yes                           | Yes                           | Yes                           | Yes                           | Yes                           | Yes                           |
| Delicate 40°C  | No                            | No                            | No                            | No                            | No                            | No                            | Yes                           | Yes                           |
| Daily 60°C   | No                            | No                            | No                            | No                            | No                            | No                            | No                            | No                            |
| Normal 55°C  | No                            | No                            | No                            | No                            | No                            | No                            | No                            | No                            |
| Auto Delicate 30°C - 50°C  | No                            | No                            | No                            | No                            | No                            | No                            | No                            | No                            |
| Auto Normal 50°C - 60°C  | No                            | No                            | No                            | No                            | No                            | No                            | No                            | No                            |
| Auto Intensive 60°C - 70°C   | No                            | No                            | No                            | No                            | No                            | No                            | No                            | No                            |
| User Interface   |                               |                               |                               |                               |                               |                               |                               |                               |
| Start/Pause  | Yes                           | Yes                           | Yes                           | Yes                           | Yes                           | Yes                           | Yes                           | Yes                           |
| DISPLAY (delay start (1-2-3...-19hr), remaining time)                  | No                            | Yes                           | No                            | Yes                           | No                            | Yes                           | No                            | Yes                           |
| Delay timer  | Yes (3hr,6hr,9hr)             | Yes                           | Yes (3hr,6hr,9hr)             | Yes                           | Yes (3hr,6hr,9hr)             | Yes                           | Yes (3hr,6hr,9hr)             | Yes                           |
| Program selection button   | Yes                           | Yes                           | Yes                           | Yes                           | Yes                           | Yes                           | Yes                           | Yes                           |
| Half load (with 1 mode)  | Yes                           | Yes                           | Yes                           | Yes                           | Yes                           | Yes                           | Yes                           | Yes                           |
| Half load button (with 3 modes)  | No                            | No                            | No                            | No                            | No                            | No                            | No                            | No                            |
| Tablet button  | No                            | Yes                           | No                            | Yes                           | No                            | Yes                           | No                            | Yes                           |
| Extra Hygiene option   | No                            | Yes                           | No                            | Yes                           | No                            | Yes                           | No                            | Yes                           |
| Extra Rinse option   | No                            | Yes                           | No                            | Yes                           | No                            | Yes                           | No                            | Yes                           |
| Extra Dry option   | No                            | Yes                           | No                            | Yes                           | No                            | Yes                           | No                            | Yes                           |
| Rinse-aid indicator  | Yes                           | Yes                           | Yes                           | Yes                           | Yes                           | Yes                           | Yes                           | Yes                           |
| Salt indicator   | Yes                           | Yes                           | Yes                           | Yes                           | Yes                           | Yes                           | Yes                           | Yes                           |
| Washing cycle indicators   | Yes                           | Yes                           | Yes                           | Yes                           | Yes                           | Yes                           | Yes                           | Yes                           |
| Child Lock   | No                            | Yes                           | No                            | Yes                           | No                            | Yes                           | No                            | Yes                           |
| Baskets & Accessories  |                               |                               |                               |                               |                               |                               |                               |                               |
| 3rd basket   | No                            | No                            | No                            | No                            | No                            | No                            | No                            | No                            |
| Upper basket types [mesh type / peg type]                              | (o)                           | (o)                           | (o)                           | (o)                           | (o)                           | (o)                           | (o)                           | (o)                           |
| Adjustable upper basket when empty                                     | (o)                           | (o)                           | (o)                           | (o)                           | (o)                           | (o)                           | (o)                           | (o)                           |
| Adjustable upper basket when loaded                                    | (o)                           | (o)                           | (o)                           | (o)                           | (o)                           | (o)                           | (o)                           | (o)                           |
| Number of mug shelves  | 2 (std) / 4 (o)               | 2 (std) / 4 (o)               | 2 (std) / 4 (o)               | 2 (std) / 4 (o)               | 2 (std) / 4 (o)               | 2 (std) / 4 (o)               | 2 (std) / 4 (o)               | 2 (std) / 4 (o)               |
| Adjustable mug shelves (peg)   | Yes                           | Yes                           | Yes                           | Yes                           | Yes                           | Yes                           | Yes                           | Yes                           |
| Adjustable mug shelves (mesh)  | (o)                           | (o)                           | (o)                           | (o)                           | (o)                           | (o)                           | (o)                           | (o)                           |
| Foldable racks on upper basket (peg)                                   | fixed (std) / 2 or 4 or 6 (o) | fixed (std) / 2 or 4 or 6 (o) | fixed (std) / 2 or 4 or 6 (o) | fixed (std) / 2 or 4 or 6 (o) | fixed (std) / 2 or 4 or 6 (o) | fixed (std) / 2 or 4 or 6 (o) | fixed (std) / 2 or 4 or 6 (o) | fixed (std) / 2 or 4 or 6 (o) |
| Foldable racks on lower basket   | (o)                           | (o)                           | (o)                           | (o)                           | (o)                           | (o)                           | (o)                           | (o)                           |
| Wire basket handles  | (o)                           | (o)                           | (o)                           | (o)                           | (o)                           | (o)                           | (o)                           | (o)                           |
| Plastic basket handles   | (o)                           | (o)                           | (o)                           | (o)                           | (o)                           | (o)                           | (o)                           | (o)                           |
| Removable cutlery basket (Single piece)                                | (o)                           | (o)                           | (o)                           | (o)                           | (o)                           | (o)                           | (o)                           | (o)                           |
| Removable cutlery basket (Universal)                                   | No                            | No                            | No                            | No                            | No                            | No                            | No                            | No                            |
| Removable cutlery basket (Modular) (2)                                 | (o)                           | (o)                           | (o)                           | (o)                           | (o)                           | (o)                           | (o)                           | (o)                           |
| Removable cutlery basket (Sliding) (3)                                 | (o)                           | (o)                           | (o)                           | (o)                           | (o)                           | (o)                           | (o)                           | (o)                           |
| Multi func. kit (Extra mug shelves + higher rear part on lower basket) | (o)                           | (o)                           | (o)                           | (o)                           | (o)                           | (o)                           | (o)                           | (o)                           |
| Bottle holder on lower basket  | (o)                           | (o)                           | (o)                           | (o)                           | (o)                           | (o)                           | (o)                           | (o)                           |
| Wine stem support & Spoon rack on upper basket (2)                     | (o)                           | (o)                           | (o)                           | (o)                           | (o)                           | (o)                           | (o)                           | (o)                           |
| Top nozzle   | No                            | No                            | No                            | No                            | No                            | No                            | No                            | No                            |
| Aquastop external hose   | (o)                           | (o)                           | (o)                           | (o)                           | (o)                           | (o)                           | (o)                           | (o)                           |
| Interior light   | No                            | No                            | No                            | No                            | No                            | No                            | No                            | No                            |
| Performance (4)  |                               |                               |                               |                               |                               |                               |                               |                               |
| Noise Level (dB(A))  | 57/54/52/49/47/45             | 57/54/52/49/47/45             | 57/54/52/49/47/45             | 57/54/52/49/47/45             | 57/54/52/49/47/45             | 57/54/52/49/47/45             | 57/54/52/49/47/45             | 57/54/52/49/47/45             |
| Energy efficiency class  | A++                           | A++                           | A++                           | A++                           | A++                           | A++                           | A++                           | A++                           |
| Cleaning performance   | A                             | A                             | A                             | A                             | A                             | A                             | A                             | A                             |
| Drying performance   | A                             | A                             | A                             | A                             | A                             | A                             | A                             | A                             |
| Water consumption (lt)   | 12                            | 12                            | 12                            | 12                            | 12                            | 12                            | 12                            | 12                            |
| Annual water consumption (lt/year)                                     | 3360                          | 3360                          | 3360                          | 3360                          | 3360                          | 3360                          | 3360                          | 3360                          |
| Program duration (min)   | 165                           | 165                           | 165                           | 165                           | 165                           | 165                           | 165                           | 165                           |
| Energy consumption (kWh)   | 0,90                          | 0,90                          | 0,90                          | 0,90                          | 0,90                          | 0,90                          | 0,90                          | 0,90                          |
| Annual energy consumption (kWh/year)                                   | 258                           | 258                           | 258                           | 258                           | 258                           | 258                           | 258                           | 258                           |
| Voltage (V) / Frequency (Hz)   | 220-240 / 50                  | 220-240 / 50                  | 220-240 / 50                  | 220-240 / 50                  | 220-240 / 50                  | 220-240 / 50                  | 220-240 / 50                  | 220-240 / 50                  |
| Fuse Rating (A)  | 10                            | 10                            | 10                            | 10                            | 10                            | 10                            | 10                            | 10                            |
| Dimensions   |                               |                               |                               |                               |                               |                               |                               |                               |
| Height (cm)  | 82,0                          | 82,0                          | 82,0                          | 82,0                          | 82,0                          | 82,0                          | 82,0                          | 82,0                          |
| Width (cm)   | 59,8                          | 59,8                          | 59,8                          | 59,8                          | 59,8                          | 59,8                          | 59,8                          | 59,8                          |
| Depth (cm)   | 57,0                          | 57,0                          | 57,0                          | 57,0                          | 57,0                          | 57,0                          | 57,0                          | 57,0                          |
| Height adjustment (+cm)  | 5                             | 5                             | 5                             | 5                             | 5                             | 5                             | 5                             | 5                             |
| Packed dimensions (Height x Width x Depth) (cm)                        | 85,1 x 64,4 x 66,1            | 85,1 x 64,4 x 66,1            | 85,1 x 64,4 x 66,1            | 85,1 x 64,4 x 66,1            | 85,1 x 64,4 x 66,1            | 85,1 x 64,4 x 66,1            | 85,1 x 64,4 x 66,1            | 85,1 x 64,4 x 66,1            |
| Stacking quantity (pcs)  | 5                             | 5                             | 5                             | 5                             | 5                             | 5                             | 5                             | 5                             |
| Gross/Net weight (kg/5)  | 43 /41                        | 43 /41                        | 43 /41                        | 43 /41                        | 43 /41                        | 43 /41                        | 43 /41                        | 43 /41                        |
| Container loading (40°C/40' 20')                                       | 162 /108 /54                  | 162 /108 /54                  | 162 /108 /54                  | 162 /108 /54                  | 162 /108 /54                  | 162 /108 /54                  | 162 /108 /54                  | 162 /108 /54                  |

| SEMI-INTEGRATED Y SERIES 60cm Models                                   | Y15                           | Y1E                           | Y1F                           | Y21                           | Y22                           | Y23                           | Y24                           |
|--|-------------------------------|-------------------------------|-------------------------------|-------------------------------|-------------------------------|-------------------------------|-------------------------------|
| General Characteristics  |                               |                               |                               |                               |                               |                               |                               |
| Number of Place Settings   | 12                            | 12                            | 12                            | 12/15                         | 12/15                         | 12/15                         | 12/15                         |
| Number of programs   | 6                             | 6                             | 7                             | 6                             | 7                             | 8                             | 9                             |
| Temperatures (°C)  | 40-50-65-70                   | 40-50-65-70                   | 40-50-65-70                   | 40-50-65                      | 40-50-55-65                   | 40-50-55-60-70                | Auto-30-40-50-55-60-70        |
| Control type   | full-electronic               | full-electronic               | full-electronic               | full-electronic               | full-electronic               | full-electronic               | full-electronic               |
| Hidden heating element   | Yes                           | Yes                           | Yes                           | Yes                           | Yes                           | Yes                           | Yes                           |
| Filter type  | Metal / Plastic               | Metal / Plastic               | Metal / Plastic               | Metal / Plastic               | Metal / Plastic               | Metal / Plastic               | Metal / Plastic               |
| Turbidity sensor   | No                            | No                            | No                            | No                            | No                            | No                            | Yes                           |
| Drying system  | Mini Active/ Super Active     | Mini Active/ Super Active     | Mini Active/ Super Active     | Super Active/ Turbo(1)        | Super Active/ Turbo(1)        | Super Active/ Turbo(1)        | Super Active/ Turbo(1)        |
| Overflow & leakage protection  | Yes                           | Yes                           | Yes                           | Yes                           | Yes                           | Yes                           | Yes                           |
| Heater protection  | Yes                           | Yes                           | Yes                           | Yes                           | Yes                           | Yes                           | Yes                           |
| Circulation Pump   | Asynchronous                  | Asynchronous                  | Asynchronous                  | Asynchronous                  | Asynchronous                  | Asynchronous                  | Asynchronous                  |
| Programs   |                               |                               |                               |                               |                               |                               |                               |
| Prewash  | Yes                           | Yes                           | Yes                           | Yes                           | Yes                           | Yes                           | Yes                           |
| Eco  | Yes                           | Yes                           | Yes                           | Yes                           | Yes                           | Yes                           | Yes                           |
| Intensive 65°C   | Yes                           | Yes                           | Yes                           | Yes                           | Yes                           | Yes                           | No                            |
| Steam Wash   | No                            | No                            | No                            | No                            | No                            | No                            | Yes                           |
| Quick 30' 40°C   | Yes                           | Yes                           | Yes                           | Yes                           | Yes                           | Yes                           | Yes                           |
| Super 50' 65°C   | Yes                           | Yes                           | Yes                           | Yes                           | Yes                           | Yes                           | Yes                           |
| Delicate 40°C  | Yes                           | Yes                           | Yes                           | Yes                           | Yes                           | Yes                           | No                            |
| Daily 60°C   | No                            | No                            | Yes                           | No                            | Yes                           | Yes                           | Yes                           |
| Normal 55°C  | No                            | No                            | No                            | No                            | Yes                           | Yes                           | No                            |
| Auto Delicate 30°C - 50°C  | No                            | No                            | No                            | No                            | No                            | No                            | Yes                           |
| Auto Normal 50°C - 60°C  | No                            | No                            | No                            | No                            | No                            | No                            | Yes                           |
| Auto Intensive 60°C - 70°C   | No                            | No                            | No                            | No                            | No                            | No                            | Yes                           |
| User Interface   |                               |                               |                               |                               |                               |                               |                               |
| Start/Pause  | Yes                           | Yes                           | Yes                           | Yes                           | Yes                           | Yes                           | Yes                           |
| DISPLAY (delay start (1-2-3...19hr), remaining time)                   | No                            | Yes                           | Yes                           | Yes                           | Yes                           | Yes                           | Yes                           |
| Delay timer  | Yes (3hr,6hr,9hr)             | Yes                           | Yes                           | Yes                           | Yes                           | Yes                           | Yes                           |
| Program selection button   | Yes                           | Yes                           | Yes                           | Yes                           | Yes                           | Yes                           | Yes                           |
| Half load (with 1 mode)  | Yes                           | Yes                           | Yes                           | No                            | No                            | No                            | No                            |
| Half load button (with 3 modes)  | No                            | No                            | No                            | Yes                           | Yes                           | Yes                           | Yes                           |
| Tablet button  | Yes                           | Yes                           | Yes                           | Yes                           | Yes                           | Yes                           | Yes                           |
| Extra Hygiene option   | No                            | Yes                           | Yes                           | Yes                           | Yes                           | Yes                           | Yes                           |
| Extra Rinse option   | No                            | Yes                           | Yes                           | Yes                           | Yes                           | Yes                           | Yes                           |
| Extra Dry option   | No                            | Yes                           | Yes                           | Yes                           | Yes                           | Yes                           | Yes                           |
| Rinse-aid indicator  | Yes                           | Yes                           | Yes                           | Yes                           | Yes                           | Yes                           | Yes                           |
| Salt indicator   | Yes                           | Yes                           | Yes                           | Yes                           | Yes                           | Yes                           | Yes                           |
| Washing cycle indicators   | Yes                           | Yes                           | Yes                           | Yes                           | Yes                           | Yes                           | Yes                           |
| Child Lock   | No                            | Yes                           | Yes                           | Yes                           | Yes                           | Yes                           | Yes                           |
| Baskets & Accessories  |                               |                               |                               |                               |                               |                               |                               |
| 3rd basket   | No                            | No                            | No                            | No(12ps), Yes (15ps)          | No(12ps), Yes (15ps)          | No(12ps), Yes (15ps)          | No(12ps), Yes (15ps)          |
| Upper basket types [mesh type / peg type]                              | (o)                           | (o)                           | (o)                           | (o)                           | (o)                           | (o)                           | (o)                           |
| Adjustable upper basket when empty                                     | (o)                           | (o)                           | (o)                           | (o)                           | (o)                           | (o)                           | (o)                           |
| Adjustable upper basket when loaded                                    | (o)                           | (o)                           | (o)                           | (o)                           | (o)                           | (o)                           | (o)                           |
| Number of mug shelves  | 2 (std) / 4 (o)               | 2 (std) / 4 (o)               | 2 (std) / 4 (o)               | 2 (std) / 4 (o)               | 2 (std) / 4 (o)               | 2 (std) / 4 (o)               | 2 (std) / 4 (o)               |
| Adjustable mug shelves (peg)   | Yes                           | Yes                           | Yes                           | Yes                           | Yes                           | Yes                           | Yes                           |
| Adjustable mug shelves (mesh)  | (o)                           | (o)                           | (o)                           | (o)                           | (o)                           | (o)                           | (o)                           |
| Foldable racks on upper basket (peg)                                   | fixed (std) / 2 or 4 or 6 (o) | fixed (std) / 2 or 4 or 6 (o) | fixed (std) / 2 or 4 or 6 (o) | fixed (std) / 2 or 4 or 6 (o) | fixed (std) / 2 or 4 or 6 (o) | fixed (std) / 2 or 4 or 6 (o) | fixed (std) / 2 or 4 or 6 (o) |
| Foldable racks on lower basket   | (o)                           | (o)                           | (o)                           | (o)                           | (o)                           | (o)                           | (o)                           |
| Wire basket handles  | (o)                           | (o)                           | (o)                           | (o)                           | (o)                           | (o)                           | (o)                           |
| Plastic basket handles   | (o)                           | (o)                           | (o)                           | (o)                           | (o)                           | (o)                           | (o)                           |
| Removable cutlery basket (Single piece)                                | (o)                           | (o)                           | (o)                           | (o)(12ps) / No(15ps)          | (o)(12ps) / No(15ps)          | (o)(12ps) / No(15ps)          | (o)(12ps) / No(15ps)          |
| Removable cutlery basket (Universal)                                   | No                            | No                            | No                            | No(12ps) / (o)(15ps)          | No(12ps) / (o)(15ps)          | No(12ps) / (o)(15ps)          | No(12ps) / (o)(15ps)          |
| Removable cutlery basket (Modular) (2)                                 | (o)                           | (o)                           | (o)                           | (o)                           | (o)                           | (o)                           | (o)                           |
| Removable cutlery basket (Sliding) (3)                                 | (o)                           | (o)                           | (o)                           | (o)(12ps) / No(15ps)          | (o)(12ps) / No(15ps)          | (o)(12ps) / No(15ps)          | (o)(12ps) / No(15ps)          |
| Multi func. kit (Extra mug shelves + higher rear part on lower basket) | (o)                           | (o)                           | (o)                           | (o)                           | (o)                           | (o)                           | (o)                           |
| Bottle holder on lower basket  | (o)                           | (o)                           | (o)                           | (o)                           | (o)                           | (o)                           | (o)                           |
| Wine stem support & Spoon rack on upper basket (2)                     | (o)                           | (o)                           | (o)                           | (o)                           | (o)                           | (o)                           | (o)                           |
| Top nozzle   | No                            | No                            | No                            | (o)(12ps) / Yes(15ps)         | (o)(12ps) / Yes(15ps)         | (o)(12ps) / Yes(15ps)         | (o)(12ps) / Yes(15ps)         |
| Aquastop external hose   | (o)                           | (o)                           | (o)                           | (o)                           | (o)                           | (o)                           | (o)                           |
| Interior light   | No                            | No                            | No                            | (o)                           | (o)                           | (o)                           | (o)                           |
| Performance (4)  |                               |                               |                               |                               |                               |                               |                               |
| Noise Level (dB(A))  | 57/54/52/49/47/45             | 57/54/52/49/47/45             | 57/54/52/49/47/45             | 57/54/52/49/47/45             | 54/52/49/47/45                | 54/52/49/47/45                | 54/52/49/47/45                |
| Energy efficiency class  | A++                           | A++                           | A++                           | A++                           | A++                           | A++                           | A++                           |
| Cleaning performance   | A                             | A                             | A                             | A                             | A                             | A                             | A                             |
| Drying performance   | A                             | A                             | A                             | A                             | A                             | A                             | A                             |
| Water consumption (lt)   | 12                            | 12                            | 12                            | 9                             | 9                             | 9                             | 9                             |
| Annual water consumption (lt/year)                                     | 3360                          | 3360                          | 3360                          | 2520                          | 2520                          | 2520                          | 2520                          |
| Program duration (min)   | 165                           | 165                           | 165                           | 171                           | 171                           | 171                           | 171                           |
| Energy consumption (kWh)   | 0,90                          | 0,90                          | 0,90                          | 0,90 / 0,94                   | 0,90 / 0,94                   | 0,90 / 0,94                   | 0,90 / 0,94                   |
| Annual energy consumption (kWh/year)                                   | 258                           | 258                           | 258                           | 258 / 267                     | 258 / 267                     | 258 / 267                     | 258 / 267                     |
| Voltage (V) / Frequency (Hz)   | 220-240 / 50                  | 220-240 / 50                  | 220-240 / 50                  | 220-240 / 50                  | 220-240 / 50                  | 220-240 / 50                  | 220-240 / 50                  |
| Fuse Rating (A)  | 10                            | 10                            | 10                            | 10                            | 10                            | 10                            | 10                            |
| Dimensions   |                               |                               |                               |                               |                               |                               |                               |
| Height (cm)  | 82,0                          | 82,0                          | 82,0                          | 82,0                          | 82,0                          | 82,0                          | 82,0                          |
| Width (cm)   | 59,8                          | 59,8                          | 59,8                          | 59,8                          | 59,8                          | 59,8                          | 59,8                          |
| Depth (cm)   | 57,0                          | 57,0                          | 57,0                          | 57,0                          | 57,0                          | 57,0                          | 57,0                          |
| Height adjustment (+cm)  | 5                             | 5                             | 5                             | 5                             | 5                             | 5                             | 5                             |
| Packed dimensions (Height x Width x Depth) (cm)                        | 85,1 x 64,4 x 66, 1           | 85,1 x 64,4 x 66, 1           | 85,1 x 64,4 x 66, 1           | 85,1 x 64,4 x 66, 1           | 85,1 x 64,4 x 66, 1           | 85,1 x 64,4 x 66, 1           | 85,1 x 64,4 x 66, 1           |
| Stacking quantity (pcs)  | 5                             | 5                             | 5                             | 5                             | 5                             | 5                             | 5                             |
| Gross/Net weight (kg/5)  | 43 /41                        | 43 /41                        | 43 /41                        | 43 /41                        | 43 /41                        | 43 /41                        | 43 /41                        |
| Container loading (40'H/C/ 40'/ 20')                                   | 162 /108 /54                  | 162 /108 /54                  | 162 /108 /54                  | 162 /108 /54                  | 162 /108 /54                  | 162 /108 /54                  | 162 /108 /54                  |

Notes

- (o) : Optional
- (1) : Turbo fan drying system & 3rd basket are default for 15ps models
- (2) : Modular cutlery basket for 12 PS must be selected with wine stem support & spoon rack. Also wine stem support & spoon rack can be selected only for mesh type upper basket option.
- (3) : Can be selected for lower basket with fixed type or with 4 foldable wire.
- (4) : Based on the tests performed with Eco program in accordance with EN 50242.
- (5) : Gros/Net Weights are shown as reference in the table. It should be calculated based on the final product features created from this general spect table.

# DISHWASHERS//SPECIFICATIONS

| SEMI-INTEGRATED T SERIES 60cm Models                                   | T11                           | T12                           | T13                           | T21                           | T24                           | T25                 |
|--|-------------------------------|-------------------------------|-------------------------------|-------------------------------|-------------------------------|---------------------|
| General Characteristics  |                               |                               |                               |                               |                               |                     |
| Number of Place Settings   | 12                            | 12                            | 12                            | 12/15                         | 12/15                         | 14                  |
| Number of programs   | 3                             | 4                             | 6                             | 8                             | 8                             | 8                   |
| Temperatures (°C)  | 50-65                         | 40-50-65                      | 40-50-65                      | Auto-30-40-50-60-70           | Auto-30-40-50-60-70           | Auto-30-40-50-60-70 |
| Control type   | full-electronic               | full-electronic               | full-electronic               | full-electronic               | full-electronic               | full-electronic     |
| Hidden heating element   | Yes                           | Yes                           | Yes                           | Yes                           | Yes                           | Yes                 |
| Filter type  | Metal / Plastic               | Metal / Plastic               | Metal / Plastic               | Metal / Plastic               | Metal                         | Metal               |
| Turbidity sensor   | No                            | No                            | No                            | Yes                           | Yes                           | Yes                 |
| Drying system  | Mini Active/ Super Active     | Mini Active/ Super Active     | Mini Active/ Super Active     | Super Active/ Turbo(1)        | Turbo                         | Turbo               |
| Overflow & leakage protection  | Yes                           | Yes                           | Yes                           | Yes                           | Yes                           | Yes                 |
| Heater protection  | Yes                           | Yes                           | Yes                           | Yes                           | Yes                           | Yes                 |
| Circulation Pump   | Asynchronous                  | Asynchronous                  | Asynchronous                  | Asynchronous                  | BLDC                          | BLDC                |
| Auto Door Technology   | No                            | No                            | No                            | No                            | Yes                           | Yes                 |
| Water Box Technology   | No                            | No                            | No                            | No                            | No                            | Yes                 |
| Triple Wash  | No                            | No                            | No                            | No                            | No                            | (o)                 |
| Direct Wash  | No                            | No                            | No                            | No                            | No                            | (o)                 |
| Programs   |                               |                               |                               |                               |                               |                     |
| Prewash  | No                            | No                            | Yes                           | Yes                           | No                            | No                  |
| Mini 18'   | No                            | No                            | No                            | No                            | Yes                           | Yes                 |
| Eco 50°C   | Yes                           | Yes                           | Yes                           | Yes                           | Yes                           | Yes                 |
| Intensive 65°C   | Yes                           | Yes                           | Yes                           | No                            | No                            | No                  |
| Quick 30' 40°C   | No                            | Yes                           | Yes                           | Yes                           | Yes                           | Yes                 |
| Super 50' 65 °C  | Yes                           | Yes                           | Yes                           | Yes                           | Yes                           | Yes                 |
| Delicate 40°C  | No                            | No                            | Yes                           | No                            | No                            | No                  |
| Daily 60°C   | No                            | No                            | No                            | Yes                           | No                            | No                  |
| Auto Delicate 30°C - 50°C  | No                            | No                            | No                            | Yes                           | Yes                           | Yes                 |
| Auto Normal 50°C - 60°C  | No                            | No                            | No                            | Yes                           | No                            | No                  |
| Auto Intensive 60°C - 70°C   | No                            | No                            | No                            | Yes                           | Yes (50°C-70°C)               | Yes (50°C-70°C)     |
| Hygiene 60°C   | No                            | No                            | No                            | No                            | No                            | No                  |
| Hygiene 70°C   | No                            | No                            | No                            | No                            | Yes                           | Yes                 |
| Dual Pro Wash 60°C   | No                            | No                            | No                            | No                            | Yes                           | Yes                 |
| Extra Intensive 70°C (Prewash Button + Intensive 65°C)                 | No                            | No                            | No                            | No                            | No                            | No                  |
| Extra Hygiene 70°C (Prewash Button + Hygiene 60°C)                     | No                            | No                            | No                            | No                            | No                            | No                  |
| User Interface   |                               |                               |                               |                               |                               |                     |
| Start/Pause  | Yes                           | Yes                           | Yes                           | Yes                           | Yes                           | Yes                 |
| DISPLAY (delay start (1-2-3...-24hr), remaining time)                  | No                            | Yes                           | Yes                           | Yes                           | Yes                           | Yes                 |
| Program selection button   | Yes                           | Yes                           | Yes                           | Yes                           | Yes                           | Yes                 |
| Delay timer button   | No                            | Yes                           | Yes                           | Yes                           | Yes                           | Yes                 |
| Hygiene button   | No                            | No                            | Yes                           | Yes                           | No                            | No                  |
| Tablet button  | No                            | No                            | Yes                           | Yes                           | Yes                           | Yes                 |
| Half load button (1 mode)  | Yes                           | Yes                           | Yes                           | No                            | No                            | No                  |
| Half load button (with 3 modes)  | No                            | No                            | No                            | Yes                           | Yes                           | Yes                 |
| Energy Save button   | No                            | No                            | No                            | No                            | Yes                           | Yes                 |
| Extra Rinse option   | No                            | No                            | No                            | Yes                           | No                            | No                  |
| Extra Dry option   | No                            | No                            | No                            | Yes                           | No                            | No                  |
| Extra Silent option  | No                            | No                            | No                            | No                            | Yes                           | Yes                 |
| Extra Fast option  | No                            | No                            | No                            | No                            | Yes                           | Yes                 |
| Rinse-aid indicator  | Yes                           | Yes                           | Yes                           | Yes                           | Yes                           | Yes                 |
| Salt indicator   | Yes                           | Yes                           | Yes                           | Yes                           | Yes                           | Yes                 |
| Washing cycle indicators   | Yes                           | Yes                           | Yes                           | Yes                           | Yes                           | Yes                 |
| Child Lock   | Yes                           | Yes                           | Yes                           | Yes                           | Yes                           | Yes                 |
| Baskets & Accessories  |                               |                               |                               |                               |                               |                     |
| 3rd basket   | No                            | No                            | No                            | No(12ps), Yes (15ps)          | No(12ps), Yes (15ps)          | Yes (14ps)          |
| Upper basket types [mesh type / peg type]                              | (o)                           | (o)                           | (o)                           | (o)                           | (o)                           | Peg                 |
| Adjustable upper basket when empty                                     | (o)                           | (o)                           | (o)                           | (o)                           | (o)                           | Yes                 |
| Adjustable upper basket when loaded                                    | (o)                           | (o)                           | (o)                           | (o)                           | (o)                           | (o)                 |
| Number of mug shelves  | 2 (std) / 4 (o)               | 2 (std) / 4 (o)               | 2 (std) / 4 (o)               | 2 (std) / 4 (o)               | 2 (std) / 4 (o)               | 2 (std) / 4 (o)     |
| Adjustable mug shelves (peg)   | Yes                           | Yes                           | Yes                           | Yes                           | Yes                           | Yes                 |
| Adjustable mug shelves (mesh)  | (o)                           | (o)                           | (o)                           | (o)                           | (o)                           | No                  |
| Foldable racks on upper basket (peg)                                   | fixed (std) / 2 or 4 or 6 (o) | fixed (std) / 2 or 4 or 6 (o) | fixed (std) / 2 or 4 or 6 (o) | fixed (std) / 2 or 4 or 6 (o) | fixed (std) / 2 or 4 or 6 (o) | 4 or 6 (o)          |
| Foldable racks on lower basket   | (o)                           | (o)                           | (o)                           | (o)                           | (o)                           | Yes                 |
| Wire basket handles  | (o)                           | (o)                           | (o)                           | (o)                           | (o)                           | No                  |
| Plastic basket handles   | (o)                           | (o)                           | (o)                           | (o)                           | (o)                           | Yes                 |
| Removable cutlery basket (Single piece)                                | (o)                           | (o)                           | (o)                           | (o)(12ps) / No(15ps)          | (o)(12ps) / No(15ps)          | No                  |
| Removable cutlery basket (Universal)                                   | No                            | No                            | No                            | No(12ps) / (o)(15ps)          | No(12ps) / (o)(15ps)          | (o)                 |
| Removable cutlery basket (Modular) (2)                                 | (o)                           | (o)                           | (o)                           | (o)                           | (o)                           | (o)                 |
| Removable cutlery basket (Sliding) (3)                                 | (o)                           | (o)                           | (o)                           | (o)(12ps) / No(15ps)          | (o)(12ps) / No(15ps)          | No                  |
| Multi func. kit (Extra mug shelves + higher rear part on lower basket) | (o)                           | (o)                           | (o)                           | (o)                           | (o)                           | (o)                 |
| Bottle holder on lower basket  | (o)                           | (o)                           | (o)                           | (o)                           | (o)                           | (o)                 |
| Wine stem support & Spoon rack on upper basket (2)                     | (o)                           | (o)                           | (o)                           | (o)                           | (o)                           | (o)                 |
| Top nozzle   | No                            | No                            | No                            | (o)(12ps) / Yes(15ps)         | (o)(12ps) / Yes(15ps)         | Yes                 |
| Aquastop external hose   | (o)                           | (o)                           | (o)                           | (o)                           | (o)                           | (o)                 |
| Interior light   | No                            | No                            | No                            | (o)                           | (o)                           | No                  |
| Performance (4)  |                               |                               |                               |                               |                               |                     |
| Noise Level (dB(A))  | 57/54/52/49/47/45             | 57/54/52/49/47/45             | 57/54/52/49/47/45             | 54/52/49/47/45                | 46 (12ps), 44 (15ps)          | 44                  |
| Energy efficiency class  | A++                           | A++                           | A++                           | A++                           | A+++                          | A+++-%20            |
| Cleaning performance   | A                             | A                             | A                             | A                             | A                             | A                   |
| Drying performance   | A                             | A                             | A                             | A                             | A                             | A                   |
| Water consumption (lt)   | 12                            | 12                            | 12                            | 9                             | 9                             | 9                   |
| Annual water consumption (lt/year)                                     | 3360                          | 3360                          | 3360                          | 2520                          | 2520                          | 2520                |
| Program duration (min)   | 169                           | 169                           | 169                           | 164                           | 201                           | 207                 |
| Energy consumption (kWh)   | 0,90                          | 0,90                          | 0,90                          | 0,90 / 0,94                   | 0,79 / 0,84                   | 0,66                |
| Annual energy consumption (kWh/year)                                   | 258                           | 258                           | 258                           | 258 / 267                     | 225 / 239                     | 189                 |
| Voltage (V) / Frequency (Hz)   | 220-240 / 50                  | 220-240 / 50                  | 220-240 / 50                  | 220-240 / 50                  | 220-240 / 50                  | 220-240 / 50        |
| Fuse Rating (A)  | 10                            | 10                            | 10                            | 10                            | 10                            | 10                  |
| Dimensions   |                               |                               |                               |                               |                               |                     |
| Height (cm)  | 82,0                          | 82,0                          | 82,0                          | 82,0                          | 82,0                          | 82,0                |
| Width (cm)   | 59,8                          | 59,8                          | 59,8                          | 59,8                          | 59,8                          | 59,8                |
| Depth (cm)   | 57,0                          | 57,0                          | 57,0                          | 57,0                          | 57,0                          | 57,0                |
| Height adjustment (+cm)  | 5                             | 5                             | 5                             | 5                             | 5                             | 5                   |
| Packed dimensions (Height x Width x Depth) (cm)                        | 85,1 x 64,4 x 66,1            | 85,1 x 64,4 x 66,1            | 85,1 x 64,4 x 66,1            | 85,1 x 64,4 x 66,1            | 85,1 x 64,4 x 66,1            | 85,1 x 64,4 x 66,1  |
| Stacking quantity (pcs)  | 5                             | 5                             | 5                             | 5                             | 5                             | 5                   |
| Gross/Net weight (kg)(5)   | 43 /41                        | 43 /41                        | 43 /41                        | 43 /41                        | 43 /41                        | 43 /41              |
| Container loading (40'H/C/ 40' 20')                                    | 162 /108 /54                  | 162 /108 /54                  | 162 /108 /54                  | 162 /108 /54                  | 162 /108 /54                  | 162 /108 /54        |

## Notes

- (o) : Optional
- (1) : Turbo fan drying system & 3rd basket are default for 15ps models
- (2) : Modular cutlery basket for 12 PS must be selected with wine stem support & spoon rack. Also wine stem support & spoon rack can be selected only for mesh type upper basket option.
- (3) : Can be selected for lower basket with fixed type or with 4 foldable wire.
- (4) : Based on the tests performed with Eco 50°C program in accordance with EN 50242.
- (5) : Gros/Net Weights are shown as reference in the table. It should be calculated based on the final product features created from this general spect table.

| SEMI-INTEGRATED T3X (LED) SERIES 60cm Models                           | T31                           | T32                           | T34                           | T35                 |
|--|-------------------------------|-------------------------------|-------------------------------|---------------------|
| General Characteristics  |                               |                               |                               |                     |
| Number of Place Settings   | 12/15                         | 12/15                         | 12/15                         | 14                  |
| Number of programs   | 6                             | 8                             | 8                             | 8                   |
| Temperatures (°C)  | Auto-30-40-50-60-70           | Auto-30-40-50-60-70           | Auto-30-40-50-60-70           | Auto-30-40-50-60-70 |
| Control type   | full-electronic               | full-electronic               | full-electronic               | full-electronic     |
| Hidden heating element   | Yes                           | Yes                           | Yes                           | Yes                 |
| Filter type  | Metal / Plastic               | Metal / Plastic               | Metal                         | Metal               |
| Turbidity sensor   | Yes                           | Yes                           | Yes                           | Yes                 |
| Drying system  | Super Active/ Turbo(1)        | Super Active/ Turbo(1)        | Turbo                         | Turbo               |
| Overflow & leakage protection  | Yes                           | Yes                           | Yes                           | Yes                 |
| Heater protection  | Yes                           | Yes                           | Yes                           | Yes                 |
| Circulation Pump   | Asynchronous                  | Asynchronous                  | BLDC                          | BLDC                |
| Auto Door Technology   | No                            | No                            | Yes                           | Yes                 |
| Water Box Technology   | No                            | No                            | No                            | Yes                 |
| Triple Wash  | (o)                           | (o)                           | (o)                           | (o)                 |
| Direct Wash  | (o)                           | (o)                           | (o)                           | (o)                 |
| Programs   |                               |                               |                               |                     |
| Prewash  | Yes                           | Yes                           | No                            | No                  |
| Eco 50°C   | Yes                           | Yes                           | Yes                           | Yes                 |
| Mini 18'   | Yes                           | Yes                           | Yes                           | Yes                 |
| Quick 30' 40°C   | Yes                           | Yes                           | Yes                           | Yes                 |
| Super 50' 65°C   | Yes                           | Yes                           | Yes                           | Yes                 |
| Dual Pro Wash 60°C   | No                            | No                            | Yes                           | Yes                 |
| Hygiene 70°C   | No                            | No                            | Yes                           | Yes                 |
| Auto Delicate 30°C - 50°C  | No                            | Yes                           | Yes                           | Yes                 |
| Auto Normal 50°C - 60°C  | No                            | Yes                           | No                            | No                  |
| Auto Intensive 60°C - 70°C   | Yes                           | Yes                           | Yes (50°C - 70°C)             | Yes (50°C - 70°C)   |
| User Interface   |                               |                               |                               |                     |
| Start/Pause button   | Yes                           | Yes                           | Yes                           | Yes                 |
| Program button   | Yes                           | Yes                           | Yes                           | Yes                 |
| DISPLAY (delay start (1-2-3....24hr), remaining time)                  | Yes                           | Yes                           | Yes                           | Yes                 |
| Delay timer button   | Yes                           | Yes                           | Yes                           | Yes                 |
| Tablet option  | Yes                           | Yes                           | Yes                           | Yes                 |
| Half load option (with 3 modes)  | Yes                           | Yes                           | Yes                           | Yes                 |
| Energy Save option   | No                            | No                            | Yes                           | Yes                 |
| Extra Hygiene option   | Yes                           | Yes                           | No                            | No                  |
| Extra Dry option   | Yes                           | Yes                           | No                            | No                  |
| Extra Silent option  | No                            | No                            | Yes                           | Yes                 |
| Extra Fast option  | No                            | No                            | Yes                           | Yes                 |
| Rinse-aid indicator  | Yes                           | Yes                           | Yes                           | Yes                 |
| Salt indicator   | Yes                           | Yes                           | Yes                           | Yes                 |
| Washing cycle indicators   | Yes                           | Yes                           | Yes                           | Yes                 |
| Child Lock   | Yes                           | Yes                           | Yes                           | Yes                 |
| Baskets & Accessories  |                               |                               |                               |                     |
| 3rd basket   | No(12ps), Yes (15ps)          | No(12ps), Yes (15ps)          | No(12ps), Yes (15ps)          | Yes                 |
| Upper basket types (mesh type / peg type)                              | (o)                           | (o)                           | (o)                           | Peg                 |
| Adjustable upper basket when empty                                     | (o)                           | (o)                           | (o)                           | Yes                 |
| Adjustable upper basket when loaded                                    | (o)                           | (o)                           | (o)                           | (o)                 |
| Number of mug shelves  | 2 (std) / 4 (o)               | 2 (std) / 4 (o)               | 2 (std) / 4 (o)               | 2 (std) / 4 (o)     |
| Adjustable mug shelves (peg)   | Yes                           | Yes                           | Yes                           | Yes                 |
| Adjustable mug shelves (mesh)  | (o)                           | (o)                           | (o)                           | No                  |
| Foldable racks on upper basket (peg)                                   | fixed (std) / 2 or 4 or 6 (o) | fixed (std) / 2 or 4 or 6 (o) | fixed (std) / 2 or 4 or 6 (o) | 4 or 6 (o)          |
| Foldable racks on lower basket   | (o)                           | (o)                           | (o)                           | Yes                 |
| Wire basket handles  | (o)                           | (o)                           | (o)                           | No                  |
| Plastic basket handles   | (o)                           | (o)                           | (o)                           | Yes                 |
| Removable cutlery basket (Single piece)                                | (o)(12ps) / No(15ps)          | (o)(12ps) / No(15ps)          | (o)(12ps) / No(15ps)          | No                  |
| Removable cutlery basket (Universal)                                   | No(12ps) / (o)(15ps)          | No(12ps) / (o)(15ps)          | No(12ps) / (o)(15ps)          | (o)                 |
| Removable cutlery basket (Modular) (2)                                 | (o)                           | (o)                           | (o)                           | (o)                 |
| Removable cutlery basket (Sliding) (3)                                 | (o)(12ps)/No(15ps)            | (o)(12ps)/No(15ps)            | (o)(12ps)/No(15ps)            | No                  |
| Multi func. kit (Extra mug shelves + higher rear part on lower basket) | (o)                           | (o)                           | (o)                           | (o)                 |
| Bottle holder on lower basket  | (o)                           | (o)                           | (o)                           | (o)                 |
| Wine stem support & Spoon rack on upper basket (2)                     | (o)                           | (o)                           | (o)                           | (o)                 |
| Top nozzle   | (o)(12ps) / Yes(15ps)         | (o)(12ps) / Yes(15ps)         | (o)(12ps) / Yes(15ps)         | Yes                 |
| Aquastop external hose   | (o)                           | (o)                           | (o)                           | (o)                 |
| Interior light   | (o)                           | (o)                           | (o)                           | No                  |
| Performance (4)  |                               |                               |                               |                     |
| Noise Level (dB(A))  | 54/52/49/47/45                | 54/52/49/47/45                | 46 (12ps), 44 (15ps)          | 44                  |
| Energy efficiency class  | A++                           | A++                           | A+++                          | A+++ %20            |
| Cleaning performance   | A                             | A                             | A                             | A                   |
| Drying performance   | A                             | A                             | A                             | A                   |
| Water consumption (lt)   | 9                             | 9                             | 9                             | 9                   |
| Annual water consumption (lt/year)                                     | 2520                          | 2520                          | 2520                          | 2520                |
| Program duration (min)   | 164                           | 164                           | 201                           | 207                 |
| Energy consumption (kWh)   | 0.90 / 0.94                   | 0.90 / 0.94                   | 0.79 / 0.84                   | 0.66                |
| Annual energy consumption (kWh/year)                                   | 258 / 267                     | 258 / 267                     | 225 / 239                     | 189                 |
| Voltage (V) / Frequency (Hz)   | 220-240 / 50                  | 220-240 / 50                  | 220-240 / 50                  | 220-240 / 50        |
| Fuse Rating (A)  | 10                            | 10                            | 10                            | 10                  |
| Dimensions   |                               |                               |                               |                     |
| Height (cm)  | 82,0                          | 82,0                          | 82,0                          | 82,0                |
| Width (cm)   | 59,8                          | 59,8                          | 59,8                          | 59,8                |
| Depth (cm)   | 57,0                          | 57,0                          | 57,0                          | 57,0                |
| Height adjustment (+cm)  | 5                             | 5                             | 5                             | 5                   |
| Packed dimensions (Height x Width x Depth) (cm)                        | 85,1 x 64,4 x 66,1            | 85,1 x 64,4 x 66,1            | 85,1 x 64,4 x 66,1            | 85,1 x 64,4 x 66,1  |
| Stacking quantity (pcs)  | 5                             | 5                             | 5                             | 5                   |
| Gross/Net weight (kg/5)  | 43/41                         | 43/41                         | 43/41                         | 43/41               |
| Container loading (40"/HC/ 40"/ 20")                                   | 162 /108 /54                  | 162 /108 /54                  | 162 /108 /54                  | 162 /108 /54        |

- (o) : Optional
- (1) : Turbo fan drying system & 3rd basket are default for 15ps models
- (2) : Modular cutlery basket for 12 PS must be selected with wine stem support & spoon rack. Also wine stem support & spoon rack can be selected only for mesh type upper basket option.
- (3) : Can be selected for lower basket with fixed type or with 4 foldable wire.
- (4) : Based on the tests performed with Eco 50°C program in accordance with EN 50242.
- (5) : Gros/Net Weights are shown as reference in the table. It should be calculated based on the final product features created from this general spect table.



# DISHWASHERS//SPECIFICATIONS

| FULLY-INTEGRATED D SERIES 60cm Models                                  | D13                           | D21                           | D41                           | D51                           | D52                           | D53                 |
|--|-------------------------------|-------------------------------|-------------------------------|-------------------------------|-------------------------------|---------------------|
| General Characteristics  |                               |                               |                               |                               |                               |                     |
| Number of Place Settings   | 12                            | 12                            | 12/15                         | 12                            | 12/15                         | 15                  |
| Number of programs   | 4                             | 5                             | 9+                            | 6                             | 8+                            | 8+                  |
| Temperatures (°C)  | 50-65                         | 40-50-65-70                   | Auto-30-40-50-60-70           | 40-50-65                      | Auto-30-40-50-60-70           | Auto-30-40-50-60-70 |
| Control type   | full-electronic               | full-electronic               | full-electronic               | Touch control                 | Touch control                 | Touch control       |
| Hidden heating element   | Yes                           | Yes                           | Yes                           | Yes                           | Yes                           | Yes                 |
| Filter type  | Metal / Plastic               | Metal / Plastic               | Metal / Plastic               | Metal / Plastic               | Metal / Plastic               | Metal               |
| Turbidity sensor   | No                            | No                            | Yes                           | No                            | Yes                           | Yes                 |
| Drying system  | Mini Active/ Super Active     | Mini Active/ Super Active     | Super Active/ Turbo(1)        | Mini Active/ Super Active     | Super Active/ Turbo(1)        | Turbo               |
| Overflow & leakage protection  | Yes                           | Yes                           | Yes                           | Yes                           | Yes                           | Yes                 |
| Heater protection  | Yes                           | Yes                           | Yes                           | Yes                           | Yes                           | Yes                 |
| Circulation Pump   | Asynchronous                  | Asynchronous                  | Asynchronous                  | Asynchronous                  | Asynchronous                  | BLDC                |
| Auto Door Technology   | No                            | No                            | No                            | No                            | No                            | Yes                 |
| Programs   |                               |                               |                               |                               |                               |                     |
| Prewash  | Yes                           | Yes                           | Yes                           | No                            | No                            | No                  |
| Mini 18'   | No                            | No                            | No                            | Yes                           | Yes                           | Yes                 |
| Eco 50°C   | Yes                           | Yes                           | Yes                           | Yes                           | Yes                           | Yes                 |
| Intensive 65°C   | Yes                           | No                            | No                            | Yes                           | No                            | No                  |
| Intensive 70°C   | No                            | Yes                           | No                            | No                            | No                            | No                  |
| Quick 30' 40°C   | No                            | Yes                           | Yes                           | Yes                           | Yes                           | Yes                 |
| Super 50' 65°C   | Yes                           | Yes                           | No                            | Yes                           | Yes                           | Yes                 |
| Super 55' 60°C   | No                            | No                            | Yes                           | No                            | No                            | No                  |
| Delicate 40°C  | No                            | No                            | No                            | No                            | No                            | No                  |
| Normal 55°C  | No                            | No                            | No                            | No                            | No                            | No                  |
| Dual Pro Wash 60°C   | No                            | No                            | No                            | No                            | No                            | Yes                 |
| Auto Delicate 30°C - 50°C  | No                            | No                            | Yes                           | No                            | Yes                           | Yes                 |
| Auto Normal 50°C - 60°C  | No                            | No                            | Yes                           | No                            | Yes                           | No                  |
| Auto Intensive 60°C - 70°C   | No                            | No                            | Yes                           | No                            | Yes                           | Yes (50°C-70°C)     |
| Hygiene 60°C   | No                            | No                            | Yes                           | Yes                           | Yes                           | Yes                 |
| Hygiene 70°C   | No                            | No                            | No                            | No                            | No                            | No                  |
| Extra Intensive 70°C (Prewash Button + Intensive 65°C)                 | No                            | No                            | No                            | No                            | No                            | No                  |
| Extra Hygiene 70°C (Prewash Button + Hygiene 60°C)                     | No                            | No                            | Yes                           | No                            | No                            | No                  |
| User Interface   |                               |                               |                               |                               |                               |                     |
| Program selection button   | Yes                           | Yes                           | Yes                           | Yes                           | Yes                           | Yes                 |
| Prewash button   | No                            | No                            | Yes                           | No                            | No                            | No                  |
| DISPLAY (delay start (1-2-3-...-19hr), remaining time)                 | No                            | No                            | Yes                           | Yes                           | Yes                           | Yes                 |
| Delay timer button   | No                            | Yes (3hr,6hr,9hr)             | Yes                           | Yes                           | Yes                           | Yes                 |
| Half load button (1 mode)  | No                            | No                            | No                            | Yes                           | No                            | No                  |
| Half load button (with 3 modes)  | No                            | No                            | Yes                           | No                            | Yes                           | Yes                 |
| Tablet button  | No                            | No                            | Yes                           | Yes                           | Yes                           | Yes                 |
| Energy Save button   | No                            | No                            | No                            | No                            | No                            | Yes                 |
| Extra Rinse option   | No                            | No                            | No                            | No                            | Yes                           | No                  |
| Extra Silent option  | No                            | No                            | No                            | No                            | No                            | Yes                 |
| Extra Fast option  | No                            | No                            | No                            | No                            | No                            | Yes                 |
| Rinse-aid indicator  | Yes                           | Yes                           | Yes                           | Yes                           | Yes                           | Yes                 |
| Salt indicator   | Yes                           | Yes                           | Yes                           | Yes                           | Yes                           | Yes                 |
| End of Cycle indicator   | Yes                           | Yes                           | Yes                           | No                            | No                            | No                  |
| Buzzer   | Yes                           | Yes                           | Yes                           | Yes                           | Yes                           | Yes                 |
| InfoLED  | No                            | No                            | No                            | (o)                           | (o)                           | (o)                 |
| Baskets & Accessories  |                               |                               |                               |                               |                               |                     |
| 3rd basket   | No                            | No                            | No(12ps), Yes(15ps)           | No                            | No(12ps), Yes(15ps)           | Yes                 |
| Upper basket types [mesh type / peg type]                              | (o)                           | (o)                           | (o)                           | (o)                           | (o)                           | Peg                 |
| Adjustable upper basket when empty                                     | (o)                           | (o)                           | (o)                           | (o)                           | (o)                           | Yes                 |
| Adjustable upper basket when loaded                                    | (o)                           | (o)                           | (o)                           | (o)                           | (o)                           | (o)                 |
| Number of mug shelves  | 2 (std) / 4 (o)               | 2 (std) / 4 (o)               | 2 (std) / 4 (o)               | 2 (std) / 4 (o)               | 2 (std) / 4 (o)               | 4                   |
| Adjustable mug shelves (peg)   | Yes                           | Yes                           | Yes                           | Yes                           | Yes                           | Yes                 |
| Adjustable mug shelves (mesh)  | (o)                           | (o)                           | (o)                           | (o)                           | (o)                           | No                  |
| Foldable racks on upper basket (peg)                                   | fixed (std) / 2 or 4 or 6 (o) | fixed (std) / 2 or 4 or 6 (o) | fixed (std) / 2 or 4 or 6 (o) | fixed (std) / 2 or 4 or 6 (o) | fixed (std) / 2 or 4 or 6 (o) | 4 or 6 (o)          |
| Foldable racks on lower basket   | (o)                           | (o)                           | (o)                           | (o)                           | (o)                           | Yes                 |
| Wire basket handles  | (o)                           | (o)                           | (o)                           | (o)                           | (o)                           | No                  |
| Plastic basket handles   | (o)                           | (o)                           | (o)                           | (o)                           | (o)                           | Yes                 |
| Removable cutlery basket (Single piece)                                | (o)                           | (o)                           | (o)(12ps) / No(15ps)          | (o)                           | (o)(12ps) / No(15ps)          | No                  |
| Removable cutlery basket (Universal)                                   | No                            | No                            | No(12ps) / (o)(15ps)          | No                            | No(12ps) / (o)(15ps)          | (o)                 |
| Removable cutlery basket (Modular) (2)                                 | (o)                           | (o)                           | (o)                           | (o)                           | (o)                           | (o)                 |
| Removable cutlery basket (Sliding) (3)                                 | (o)                           | (o)                           | (o)(12ps) / No(15ps)          | (o)                           | (o)(12ps) / No(15ps)          | No                  |
| Multi func. kit (Extra mug shelves + higher rear part on lower basket) | (o)                           | (o)                           | (o)                           | (o)                           | (o)                           | (o)                 |
| Bottle holder on lower basket  | (o)                           | (o)                           | (o)                           | (o)                           | (o)                           | (o)                 |
| Wine stem support & Spoon rack on upper basket (2)                     | (o)                           | (o)                           | (o)                           | (o)                           | (o)                           | (o)                 |
| Top nozzle   | No                            | No                            | (o)(12ps) / Yes(15ps)         | No                            | (o)(12ps) / Yes(15ps)         | Yes                 |
| Aquastop external hose   | (o)                           | (o)                           | (o)                           | (o)                           | (o)                           | (o)                 |
| Interior light   | No                            | (o)                           | (o)                           | (o)                           | (o)                           | (o)                 |
| Performance (4)  |                               |                               |                               |                               |                               |                     |
| Noise Level (dB(A))  | 57/54/52/49/47/45             | 57/54/52/49/47/45             | 54/52/49/47/45                | 57/54/52/49/47/45             | 54/52/49/47/45                | 44                  |
| Energy efficiency class  | A++                           | A++                           | A++                           | A++                           | A++                           | A+++                |
| Cleaning performance   | A                             | A                             | A                             | A                             | A                             | A                   |
| Drying performance   | A                             | A                             | A                             | A                             | A                             | A                   |
| Water consumption (lt)   | 12                            | 12                            | 9                             | 12                            | 9                             | 9                   |
| Annual water consumption (lt/year)                                     | 3360                          | 3360                          | 2520                          | 3360                          | 2520                          | 2520                |
| Program duration (min)   | 187                           | 187                           | 162                           | 187                           | 171                           | 195                 |
| Energy consumption (kWh)   | 0,90                          | 0,90                          | 0,90 / 0,94                   | 0,90                          | 0,90 / 0,94                   | 0,79 / 0,84         |
| Annual energy consumption (kWh/year)                                   | 258                           | 258                           | 258 / 267                     | 258                           | 258 / 267                     | 225 / 239           |
| Voltage (V) / Frequency (Hz)   | 220-240 / 50                  | 220-240 / 50                  | 220-240 / 50                  | 220-240 / 50                  | 220-240 / 50                  | 220-240 / 50        |
| Fuse Rating (A)  | 10                            | 10                            | 10                            | 10                            | 10                            | 10                  |
| Dimensions   |                               |                               |                               |                               |                               |                     |
| Height (cm)  | 82,0                          | 82,0                          | 82,0                          | 82,0                          | 82,0                          | 82,0                |
| Width (cm)   | 59,8                          | 59,8                          | 59,8                          | 59,8                          | 59,8                          | 59,8                |
| Depth (cm)   | 55,0                          | 55,0                          | 55,0                          | 55,0                          | 55,0                          | 55,0                |
| Height adjustment (+cm)  | 5                             | 5                             | 5                             | 5                             | 5                             | 5                   |
| Packed dimensions (Height x Width x Depth) (cm)                        | 85,1 x 64,4 x 66,1            | 85,1 x 64,4 x 66,1            | 85,1 x 64,4 x 66,1            | 85,1 x 64,4 x 66,1            | 85,1 x 64,4 x 66,1            | 85,1 x 64,4 x 66,1  |
| Stacking quantity (pcs)  | 5                             | 5                             | 5                             | 5                             | 5                             | 5                   |
| Gross/Net weight (kg/5)  | 40/38                         | 40/38                         | 40/38                         | 40/38                         | 40/38                         | 40/38               |
| Container loading (40*HC/ 40'/20')                                     | 162/108/54                    | 162/108/54                    | 162/108/54                    | 162/108/54                    | 162/108/54                    | 162/108/54          |

## Notes

- (o) : Optional
- (1) : Turbo fan drying system & 3rd basket are default for 15ps models
- (2) : Modular cutlery basket for 12 PS must be selected with wine stem support & spoon rack. Also wine stem support & spoon rack can be selected only for mesh type upper basket option.
- (3) : Can be selected for lower basket with fixed type or with 4 foldable wire.
- (4) : Based on the tests performed with Eco 50°C program in accordance with EN 50242.
- (5) : Gross/Net Weights are shown as reference in the table. It should be calculated based on the final product features created from this general spect table.

| SEMI-INTEGRATED SLIM X&T SERIES 45cm Models             | X13                   | X1C                   | X15                   | X1E                   | T14                   | T15                   | T21                    | T22                    | T24                    |
|---|-----------------------|-----------------------|-----------------------|-----------------------|-----------------------|-----------------------|------------------------|------------------------|------------------------|
| General Characteristics                                 |                       |                       |                       |                       |                       |                       |                        |                        |                        |
| Number of Place Settings                                | 10                    | 10                    | 10                    | 10                    | 10                    | 10                    | 10                     | 10                     | 10                     |
| Number of programs                                      | 4                     | 4                     | 6                     | 6                     | 7                     | 7                     | 8                      | 8                      | 8                      |
| Temperatures (°C)                                       | 50-65                 | 50-65                 | 40-50-65-70           | 40-50-65-70           | 40-50-65-70           | 40-50-65-70           | Auto-30-40-50-60-65-70 | Auto-30-40-50-60-65-70 | Auto-30-40-50-60-65-70 |
| Control type  | full-electronic       | full-electronic       | full-electronic       | full-electronic       | full-electronic       | full-electronic       | full-electronic        | full-electronic        | full-electronic        |
| Hidden heating element                                  | Yes                   | Yes                   | Yes                   | Yes                   | Yes                   | Yes                   | Yes                    | Yes                    | Yes                    |
| Filter type   | Metal                 | Metal                 | Metal                 | Metal                 | Metal                 | Metal                 | Metal                  | Metal                  | Metal                  |
| Turbidity sensor  | No                    | No                    | No                    | No                    | No                    | No                    | Yes                    | Yes                    | Yes                    |
| Drying system   | Natural/ Super Active | Natural/ Super Active | Natural/ Super Active | Natural/ Super Active | Natural/ Super Active | Natural/ Super Active | Natural/ Super Active  | Turbo                  | Turbo                  |
| Overflow & leakage protection                           | Yes                   | Yes                   | Yes                   | Yes                   | Yes                   | Yes                   | Yes                    | Yes                    | Yes                    |
| Heater protection                                       | Yes                   | Yes                   | Yes                   | Yes                   | Yes                   | Yes                   | Yes                    | Yes                    | Yes                    |
| Circulation Pump  | Asynchronous          | Asynchronous          | Asynchronous          | Asynchronous          | Asynchronous          | Asynchronous          | Asynchronous           | Asynchronous           | BLDC                   |
| Programs  |                       |                       |                       |                       |                       |                       |                        |                        |                        |
| Prewash   | Yes                   | Yes                   | Yes                   | Yes                   | Yes                   | Yes                   | Yes                    | Yes                    | Yes                    |
| Eco 50°C  | Yes                   | Yes                   | Yes                   | Yes                   | Yes                   | Yes                   | Yes                    | Yes                    | Yes                    |
| Intensive 65°C  | Yes                   | Yes                   | Yes                   | Yes                   | Yes                   | Yes                   | No                     | No                     | No                     |
| Quick 30' 40°C  | No                    | No                    | Yes                   | Yes                   | Yes                   | Yes                   | Yes                    | Yes                    | Yes                    |
| Super 50' 65°C  | Yes                   | Yes                   | Yes                   | Yes                   | Yes                   | Yes                   | Yes                    | Yes                    | Yes                    |
| Delicate 40°C   | No                    | No                    | No                    | No                    | Yes                   | Yes                   | No                     | No                     | No                     |
| Normal 55°C   | No                    | No                    | No                    | No                    | No                    | No                    | No                     | No                     | No                     |
| Dual Pro Wash 60°C                                      | No                    | No                    | No                    | No                    | No                    | No                    | No                     | No                     | Yes                    |
| Auto Delicate 30°C - 50°C                               | No                    | No                    | No                    | No                    | No                    | No                    | Yes                    | Yes                    | Yes                    |
| Auto Normal 50°C - 60°C                                 | No                    | No                    | No                    | No                    | No                    | No                    | Yes                    | Yes                    | No                     |
| Auto Intensive 60°C - 70°C                              | No                    | No                    | No                    | No                    | No                    | No                    | Yes                    | Yes                    | Yes (50°C - 70°C)      |
| Hygiene 60°C  | No                    | No                    | No                    | No                    | No                    | No                    | No                     | No                     | No                     |
| Hygiene 70°C  | No                    | No                    | Yes                   | Yes                   | Yes                   | Yes                   | Yes                    | Yes                    | Yes                    |
| Extra Intensive 70°C (Prewash Button + Intensive 65°C*) | No                    | No                    | No                    | No                    | No                    | No                    | No                     | No                     | No                     |
| User Interface  |                       |                       |                       |                       |                       |                       |                        |                        |                        |
| Start/Pause   | Yes                   | Yes                   | Yes                   | Yes                   | Yes                   | Yes                   | Yes                    | Yes                    | Yes                    |
| Program selection button                                | No                    | No                    | No                    | No                    | Yes                   | Yes                   | Yes                    | Yes                    | Yes                    |
| DISPLAY (delay start (1-2-3...-24hr), remaining time)   | No                    | Yes (up to 19hr)      | No                    | Yes (up to 19hr)      | Yes                   | No                    | Yes                    | Yes                    | Yes                    |
| Option button1 (Delay timer)                            | Yes (3hr,6hr,9hr)     | No                    | Yes (3hr,6hr,9hr)     | No                    | No                    | Yes (3hr,6hr,9hr)     | No                     | No                     | No                     |
| Option button1 (Half load with 1 mode)                  | Yes                   | Yes                   | Yes                   | Yes                   | Yes                   | No                    | No                     | No                     | No                     |
| Half load button (with 3 modes)                         | No                    | No                    | No                    | No                    | No                    | No                    | Yes                    | Yes                    | Yes                    |
| Extra Rinse button                                      | No                    | No                    | No                    | No                    | Yes                   | No                    | Yes                    | Yes                    | No                     |
| Extra Drying button                                     | No                    | No                    | No                    | No                    | No                    | No                    | Yes                    | Yes                    | No                     |
| Tablet button   | No                    | No                    | No                    | No                    | Yes                   | No                    | Yes                    | Yes                    | No                     |
| Energy Save option                                      | No                    | No                    | No                    | No                    | No                    | No                    | No                     | No                     | Yes                    |
| Extra Silent option                                     | No                    | No                    | No                    | No                    | No                    | No                    | No                     | No                     | Yes                    |
| Extra Fast option                                       | No                    | No                    | No                    | No                    | No                    | No                    | No                     | No                     | Yes                    |
| Rinse-aid indicator                                     | Yes                   | Yes                   | Yes                   | Yes                   | Yes                   | Yes                   | Yes                    | Yes                    | Yes                    |
| Salt indicator  | Yes                   | Yes                   | Yes                   | Yes                   | Yes                   | Yes                   | Yes                    | Yes                    | Yes                    |
| Washing cycle indicators                                | Yes                   | Yes                   | Yes                   | Yes                   | Yes                   | Yes                   | Yes                    | Yes                    | Yes                    |
| Child Lock  | No                    | Yes                   | No                    | Yes                   | Yes                   | Yes                   | Yes                    | Yes                    | Yes                    |
| Baskets & Accessories                                   |                       |                       |                       |                       |                       |                       |                        |                        |                        |
| 3rd Basket  | No                    | No                    | No                    | No                    | No                    | No                    | No                     | (o)                    | Yes                    |
| Adjustable upper basket when empty                      | Yes                   | Yes                   | Yes                   | Yes                   | Yes                   | Yes                   | Yes                    | Yes                    | Yes                    |
| Adjustable upper basket when loaded                     | (o)                   | (o)                   | (o)                   | (o)                   | (o)                   | (o)                   | (o)                    | (o)                    | (o)                    |
| Number of mug shelves                                   | 4 (std)               | 4 (std)               | 4 (std)               | 4 (std)               | 4 (std)               | 4 (std)               | 4 (std)                | 4 (std)                | 4 (std)                |
| Plastic basket handles                                  | (o)                   | (o)                   | (o)                   | (o)                   | (o)                   | (o)                   | (o)                    | (o)                    | Yes                    |
| Foldable racks on lower basket                          | (o)                   | (o)                   | (o)                   | (o)                   | (o)                   | (o)                   | (o)                    | (o)                    | (o)                    |
| Foldable racks on upper basket                          | (o)                   | (o)                   | (o)                   | (o)                   | (o)                   | (o)                   | (o)                    | (o)                    | (o)                    |
| Removable cutlery basket (Universal)                    | Yes                   | Yes                   | Yes                   | Yes                   | Yes                   | Yes                   | Yes                    | (o)                    | (o)                    |
| Top nozzle  | Yes                   | Yes                   | Yes                   | Yes                   | Yes                   | Yes                   | Yes                    | Yes                    | Yes                    |
| Aquastop external hose                                  | (o)                   | (o)                   | (o)                   | (o)                   | (o)                   | (o)                   | (o)                    | (o)                    | (o)                    |
| Interior light  | No                    | No                    | No                    | No                    | No                    | No                    | (o)                    | (o)                    | (o)                    |
| Performance (1)   |                       |                       |                       |                       |                       |                       |                        |                        |                        |
| Noise Level (dB(A))                                     | 57/54/52/49/47/45     | 57/54/52/49/47/45     | 57/54/52/49/47/45     | 57/54/52/49/47/45     | 57/54/52/49/47/45     | 57/54/52/49/47/45     | 54/52/49/47/45         | 52/49/47/45            | 44                     |
| Energy efficiency class                                 | A++(3)                | A++(3)                | A++(3)                | A++(3)                | A++(3)                | A++(3)                | A++(3)                 | A++                    | A+++                   |
| Cleaning performance                                    | A                     | A                     | A                     | A                     | A                     | A                     | A                      | A                      | A                      |
| Drying performance                                      | A                     | A                     | A                     | A                     | A                     | A                     | A                      | A                      | A                      |
| Water consumption (lt)                                  | 11(4)                 | 11(4)                 | 11(4)                 | 11(4)                 | 11(4)                 | 11(4)                 | 9                      | 9                      | 9                      |
| Annual water consumption (lt/year)                      | 3080                  | 3080                  | 3080                  | 3080                  | 3080                  | 3080                  | 2520                   | 2520                   | 2520                   |
| Program duration (min)                                  | 172                   | 172                   | 172                   | 172                   | 172                   | 172                   | 164                    | 198                    | 185                    |
| Energy consumption (kWh)                                | 0,73                  | 0,73                  | 0,73                  | 0,73                  | 0,73                  | 0,73                  | 0,73                   | 0,73                   | 0,65                   |
| Annual energy consumption (kWh/year)                    | 211                   | 211                   | 211                   | 211                   | 211                   | 211                   | 211                    | 211                    | 188                    |
| Voltage (V) / Frequency (Hz)                            | 220-240 / 50          | 220-240 / 50          | 220-240 / 50          | 220-240 / 50          | 220-240 / 50          | 220-240 / 50          | 220-240 / 50           | 220-240 / 50           | 220-240 / 50           |
| Fuse Rating (A)   | 10                    | 10                    | 10                    | 10                    | 10                    | 10                    | 10                     | 10                     | 10                     |
| Dimensions  |                       |                       |                       |                       |                       |                       |                        |                        |                        |
| Height (cm)   | 82,0                  | 82,0                  | 82,0                  | 82,0                  | 82,0                  | 82,0                  | 82,0                   | 82,0                   | 82,0                   |
| Width (cm)  | 45,0                  | 45,0                  | 45,0                  | 45,0                  | 45,0                  | 45,0                  | 45,0                   | 45,0                   | 45,0                   |
| Depth (cm)  | 57,0                  | 57,0                  | 57,0                  | 57,0                  | 57,0                  | 57,0                  | 57,0                   | 57,0                   | 57,0                   |
| Height adjustment (+cm)                                 | 5                     | 5                     | 5                     | 5                     | 5                     | 5                     | 5                      | 5                      | 5                      |
| Packed dimensions (Height x Width x Depth) (cm)         | 86,1 x 49,4 x 66,1    | 86,1 x 49,4 x 66,1    | 86,1 x 49,4 x 66,1    | 86,1 x 49,4 x 66,1    | 86,1 x 49,4 x 66,1    | 86,1 x 49,4 x 66,1    | 86,1 x 49,4 x 66,1     | 86,1 x 49,4 x 66,1     | 86,1 x 49,4 x 66,1     |
| Stacking quantity (pcs)                                 | 5                     | 5                     | 5                     | 5                     | 5                     | 5                     | 5                      | 5                      | 5                      |
| Gross/Net weight (kg)(2)                                | 34 /32                | 34 /32                | 34 /32                | 34 /32                | 34 /32                | 34 /32                | 34 /32                 | 34 /32                 | 34 /32                 |
| Container loading (40'HC/ 40'U 20')                     | 216 /144 /72          | 216 /144 /72          | 216 /144 /72          | 216 /144 /72          | 216 /144 /72          | 216 /144 /72          | 216 /144 /72           | 216 /144 /72           | 216 /144 /72           |

Notes  
 (o) : Optional  
 (1) : Based on the tests performed with Eco 50°C program in accordance with EN 50242.  
 (2) : Gros/Net Weights are shown as reference in the table. It should be calculated based on the final product features created from this general spect table.  
 (3) : A+ until April 2017  
 (4) : 13 lt until April 2017

# DISHWASHERS//SPECIFICATIONS

| FULLY-INTEGRATED SLIM D SERIES 45cm Models            | D12                   | D22                   | D32                   | D42                    | D41                    | D51                   | D52                 | D53                 |
|---|-----------------------|-----------------------|-----------------------|------------------------|------------------------|-----------------------|---------------------|---------------------|
| General Characteristics                               |                       |                       |                       |                        |                        |                       |                     |                     |
| Number of Place Settings                              | 10                    | 10                    | 10                    | 10                     | 10                     | 12                    | 12/15               | 15                  |
| Number of programs                                    | 3                     | 6                     | 8                     | 8                      | 8                      | 6                     | 8+                  | 8+                  |
| Temperatures (°C)                                     | 50-65                 | 40-50-65-70           | 40-50-60-65-70        | Auto-30-40-50-60-65-70 | Auto-30-40-50-60-65-70 | 40-50-65              | Auto-30-40-50-60-70 | Auto-30-40-50-60-70 |
| Control type  | full-electronic       | full-electronic       | full-electronic       | full-electronic        | full-electronic        | Touch control         | Touch control       | Touch control       |
| Hidden heating element                                | Yes                   | Yes                   | Yes                   | Yes                    | Yes                    | Yes                   | Yes                 | Yes                 |
| Filter type   | Metal                 | Metal                 | Metal                 | Metal                  | Metal                  | Metal                 | Metal               | Metal               |
| Turbidity sensor                                      | No                    | No                    | No                    | Yes                    | Yes                    | No                    | Yes                 | Yes                 |
| Drying system   | Natural/ Super Active | Natural/ Super Active | Natural/ Super Active | Natural/ Super Active  | Turbo                  | Natural/ Super Active | Turbo               | Turbo               |
| Overflow & leakage protection                         | Yes                   | Yes                   | Yes                   | Yes                    | Yes                    | Yes                   | Yes                 | Yes                 |
| Heater protection                                     | Yes                   | Yes                   | Yes                   | Yes                    | Yes                    | Yes                   | Yes                 | Yes                 |
| Circulation Pump                                      | Asynchronous          | Asynchronous          | Asynchronous          | Asynchronous           | Asynchronous           | Asynchronous          | Asynchronous        | BLDC                |
| Auto Door Technology                                  | No                    | No                    | No                    | No                     | No                     | No                    | No                  | Yes                 |
| Programs  |                       |                       |                       |                        |                        |                       |                     |                     |
| Prewash   | Yes                   | Yes                   | Yes                   | Yes                    | Yes                    | No                    | No                  | No                  |
| Mini 18'  | No                    | No                    | No                    | No                     | No                     | Yes                   | Yes                 | Yes                 |
| Eco 50°C  | Yes                   | Yes                   | Yes                   | Yes                    | Yes                    | Yes                   | Yes                 | Yes                 |
| Intensive 65°C  | Yes                   | Yes                   | Yes                   | No                     | No                     | Yes                   | No                  | No                  |
| Quick 30' 40°C  | No                    | Yes                   | Yes                   | Yes                    | Yes                    | Yes                   | Yes                 | Yes                 |
| Super 50' 65°C  | No                    | Yes                   | Yes                   | Yes                    | Yes                    | Yes                   | Yes                 | Yes                 |
| Delicate 40°C   | No                    | No                    | Yes                   | No                     | No                     | No                    | No                  | No                  |
| Normal 55°C   | No                    | No                    | No                    | No                     | No                     | No                    | No                  | Yes                 |
| Daily 60°C  | No                    | No                    | Yes                   | No                     | No                     | No                    | No                  | No                  |
| Auto Delicate 30°C - 50°C                             | No                    | No                    | No                    | Yes                    | Yes                    | No                    | Yes                 | Yes                 |
| Auto Normal 50°C - 60°C                               | No                    | No                    | No                    | Yes                    | Yes                    | No                    | Yes                 | No                  |
| Auto Intensive 60°C - 70°C                            | No                    | No                    | No                    | Yes                    | Yes                    | No                    | Yes                 | Yes (50°C-70°C)     |
| Hygiene 60°C  | No                    | No                    | No                    | No                     | No                     | Yes                   | Yes                 | Yes                 |
| Hygiene 70°C  | No                    | Yes                   | Yes                   | Yes                    | Yes                    | No                    | No                  | No                  |
| User Interface  |                       |                       |                       |                        |                        |                       |                     |                     |
| Program selection button                              | Yes                   | Yes                   | Yes                   | Yes                    | Yes                    | Yes                   | Yes                 | Yes                 |
| DISPLAY (delay start (1-2-3...-19hr), remaining time) | No                    | No                    | Yes                   | Yes                    | Yes                    | Yes                   | Yes                 | Yes                 |
| Delay timer button                                    | No                    | Yes (3hr,6hr,9hr)     | Yes                   | Yes                    | Yes                    | Yes                   | Yes                 | Yes                 |
| Half load button (1 mode)                             | No                    | Yes                   | Yes                   | No                     | No                     | Yes                   | No                  | No                  |
| Half load button (with 3 modes)                       | No                    | No                    | No                    | Yes                    | Yes                    | No                    | Yes                 | Yes                 |
| Tablet button   | No                    | No                    | Yes                   | Yes                    | Yes                    | Yes                   | Yes                 | Yes                 |
| Extra Rinse button                                    | No                    | No                    | No                    | No                     | No                     | No                    | Yes                 | No                  |
| Extra Silent option                                   | No                    | No                    | No                    | No                     | No                     | No                    | No                  | Yes                 |
| Extra Fast option                                     | No                    | No                    | No                    | No                     | No                     | No                    | No                  | Yes                 |
| Rinse-aid indicator                                   | Yes                   | Yes                   | Yes                   | Yes                    | Yes                    | Yes                   | Yes                 | Yes                 |
| Salt indicator  | Yes                   | Yes                   | Yes                   | Yes                    | Yes                    | Yes                   | Yes                 | Yes                 |
| End of cycle indicator                                | Yes                   | Yes                   | Yes                   | Yes                    | Yes                    | No                    | No                  | No                  |
| Buzzer  | Yes                   | Yes                   | Yes                   | Yes                    | Yes                    | Yes                   | Yes                 | Yes                 |
| InfoLED   | No                    | No                    | No                    | No                     | No                     | (o)                   | (o)                 | (o)                 |
| Baskets & Accessories                                 |                       |                       |                       |                        |                        |                       |                     |                     |
| 3rd Basket  | No                    | No                    | No                    | No                     | Yes                    | No                    | (o)                 | Yes                 |
| Adjustable upper basket when empty                    | Yes                   | Yes                   | Yes                   | Yes                    | Yes                    | Yes                   | Yes                 | Yes                 |
| Adjustable upper basket when loaded                   | (o)                   | (o)                   | (o)                   | (o)                    | (o)                    | (o)                   | (o)                 | (o)                 |
| Number of mug shelves                                 | 4 (std)               | 4 (std)               | 4 (std)               | 4 (std)                | 4 (std)                | 4 (std)               | 4 (std)             | 4 (std)             |
| Plastic basket handles                                | (o)                   | (o)                   | (o)                   | (o)                    | (o)                    | (o)                   | (o)                 | (o)                 |
| Foldable racks on lower basket                        | (o)                   | (o)                   | (o)                   | (o)                    | (o)                    | (o)                   | (o)                 | (o)                 |
| Foldable racks on upper basket                        | (o)                   | (o)                   | (o)                   | (o)                    | (o)                    | (o)                   | (o)                 | (o)                 |
| Removable cutlery basket (Universal)                  | Yes                   | Yes                   | Yes                   | Yes                    | (o)                    | Yes                   | (o)                 | (o)                 |
| Top nozzle  | Yes                   | Yes                   | Yes                   | Yes                    | Yes                    | Yes                   | Yes                 | Yes                 |
| Aquastop external hose                                | (o)                   | (o)                   | (o)                   | (o)                    | (o)                    | (o)                   | (o)                 | (o)                 |
| Interior light  | No                    | No                    | No                    | (o)                    | (o)                    | (o)                   | (o)                 | (o)                 |
| Performance (1)                                       |                       |                       |                       |                        |                        |                       |                     |                     |
| Noise Level (dB(A))                                   | 57/54/52/49/47/45     | 57/54/52/49/47/45     | 57/54/52/49/47/45     | 54/52/49/47/45         | 52/49/47/45            | 57/54/52/49/47/45     | 54/52/49/47/45      | 44                  |
| Energy efficiency class                               | A++(3)                | A++(3)                | A++(3)                | A++(3)                 | A++                    | A+                    | A++                 | A+++                |
| Cleaning performance                                  | A                     | A                     | A                     | A                      | A                      | A                     | A                   | A                   |
| Drying performance                                    | A                     | A                     | A                     | A                      | A                      | A                     | A                   | A                   |
| Water consumption (lt)                                | 11(4)                 | 11(4)                 | 11(4)                 | 12                     | 9                      | 12                    | 9                   | 9                   |
| Annual water consumption (lt/year)                    | 3080                  | 3080                  | 3080                  | 3360                   | 2520                   | 3360                  | 2520                | 2520                |
| Program duration (min)                                | 186                   | 186                   | 186                   | 167                    | 191                    | 186                   | 191                 | 185                 |
| Energy consumption (kWh)                              | 0,73                  | 0,73                  | 0,73                  | 0,73                   | 0,73                   | 0,83                  | 0,73                | 0,65                |
| Annual energy consumption (kWh/year)                  | 211                   | 211                   | 211                   | 211                    | 211                    | 237                   | 211                 | 188                 |
| Voltage (V) / Frequency (Hz)                          | 220-240 / 50          | 220-240 / 50          | 220-240 / 50          | 220-240 / 50           | 220-240 / 50           | 220-240 / 50          | 220-240 / 50        | 220-240 / 50        |
| Fuse Rating (A)                                       | 10                    | 10                    | 10                    | 10                     | 10                     | 10                    | 10                  | 10                  |
| Dimensions  |                       |                       |                       |                        |                        |                       |                     |                     |
| Height (cm)   | 82,0                  | 82,0                  | 82,0                  | 82,0                   | 82,0                   | 82,0                  | 82,0                | 82,0                |
| Width (cm)  | 45,0                  | 45,0                  | 45,0                  | 45,0                   | 45,0                   | 45,0                  | 45,0                | 45,0                |
| Depth (cm)  | 55,0                  | 55,0                  | 55,0                  | 55,0                   | 55,0                   | 55,0                  | 55,0                | 55,0                |
| Height adjustment (+cm)                               | 5                     | 5                     | 5                     | 5                      | 5                      | 5                     | 5                   | 5                   |
| Packed dimensions (Height x Width x Depth) (cm)       | 86,1 x 49,4 x 66,1    | 86,1 x 49,4 x 66,1    | 86,1 x 49,4 x 66,1    | 86,1 x 49,4 x 66,1     | 86,1 x 49,4 x 66,1     | 86,1 x 49,4 x 66,1    | 86,1 x 49,4 x 66,1  | 86,1 x 49,4 x 66,1  |
| Stacking quantity (pcs)                               | 5                     | 5                     | 5                     | 5                      | 5                      | 5                     | 5                   | 5                   |
| Gross/Net weight (kg)(2)                              | 34 /32                | 34 /32                | 34 /32                | 34 /32                 | 34 /32                 | 34 /32                | 34 /32              | 34 /32              |
| Container loading (40°HC/ 40' 20')                    | 216 /144 /72          | 216 /144 /72          | 216 /144 /72          | 216 /144 /72           | 216 /144 /72           | 216 /144 /72          | 216 /144 /72        | 216 /144 /72        |

## Notes

- (o) : Optional
- (1) : Based on the tests performed with Eco 50°C program in accordance with EN 50242.
- (2) : Gross/Net Weights are shown as reference in the table. It should be calculated based on the final product features created from this general spect table.
- (3) : A+ until April 2017
- (4) : 13 lt until April 2017

| 60cm BUILT-IN OVEN SPECIFICATION SHEET   |       | 60cm ELECTRIC BUILT-IN OVEN  | 60cm PYROLYTIC BUILT-IN OVEN                                  | 60cm ELECTRIC POLYVALENTE BUILT-IN OVEN                              |
|--|-------|--|---|--|
| Dimensions   |       |  |   |  |
| Product Height   | mm    | 595  | 595   | 595  |
| Product Width  | mm    | 595  | 595   | 595  |
| Product Depth (with / without Control Panel)   | mm    | 575 / 550  | 575 / 550   | 575 / 550  |
| Cabinet Dimensions (Width / Height / Depth) -if control panel located inside the cabinet     | mm    | 600 / 600 / 590  | 600 / 600 / 590   | 600 / 600 / 590  |
| Cabinet Dimensions (Width / Height / Depth) -if control panel not located inside the cabinet | mm    | 560 / 590 / 555  | 560 / 590 / 555   | 560 / 590 / 555  |
| Oven Features  |       |  |   |  |
| Oven Type  |       | Electric   | Electric (Pyrolytic)  | Electric   |
| Oven Volume (without/with fan)   | lt    | 61 / 56 - 72 / 65  | 56 (old platform) 65 (new platform)                           | 61 / 56 - 72 / 65  |
| Cavity Dimensions (without/with fan)   | mm    | 430 x 429 x 335 / 430 x 391 x 335 - 450 x 451 x 352 / 450 x 413x 352 | 430 x 391 x 335 (old platform) 450 x 404 x 352 (new platform) | 430 x 429 x 335 / 430 x 391 x 335 - 450 x 451 x 352 / 450 x 413x 352 |
| Oven Light (25W)   |       | Optional   | Standard  | Optional   |
| Easy to Clean Enamel   |       | Standard   | -   | Standard   |
| Catalytic Enamel Panels (Left, right and rear)   |       | Optional   | -   | Optional   |
| Pyrolytic Enamel   |       |  | Standard  |  |
| Wire Side Racks  |       | Optional   | Optional  | Optional   |
| Telescopic Rails (1 or 2 racks)  |       | Optional   | Optional  | Optional   |
| Top Heating Element  | W     | 1200   | 1200  | 1200   |
| Bottom Heating Element   | W     | 1100   | 1100  | 1100   |
| Thermostat   |       | Standard   | Electronic  | Standard   |
| Grill (Thermostatic)   | W     | 1400   | 1400  | 1400   |
| Double Grill (Thermostatic)  | W     | 2600   | 2600  | 2600   |
| Fan  | W     | 23   | 23  | 23   |
| Fan with Ring Heating Element  | W     | 2000   | 2000  | 2000   |
| Automatic Boost Function   |       | available for some control unit                                      | available for some control unit                               | available for some control unit                                      |
| Turnspit   |       | Optional   | Optional  | Optional   |
| Oven Functions   |       | Up to 9  | Up to 7   | Up to 9  |
| Thermostat Operation Indicator Light   |       | Standard   | Standard  | Standard   |
| Oven Operation Indicator Light   |       | Standard   | -   | -  |
| Hotplate Operation Indicator Light (in case of polyvalente oven)                             |       | -  | -   | Standard   |
| Oven Door lock indicator light   |       | -  | Standard  | -  |
| Minute Minder  |       | Optional   | -   | Optional   |
| Mechanical Timer   |       | Optional   | -   | Optional   |
| Analog Timer   |       | Optional   | -   | Optional   |
| Digital Clock  |       | Optional   | -   | Optional   |
| Digital Programmer   |       | Optional   | Standard  | Optional   |
| Digital Programmer with touch interface  |       | Optional   | -   | Optional   |
| Full Touch LED Display   |       | Optional   | Optional  | Optional   |
| Knob Control LED Display and Touch Interface (Visio Touch)                                   |       | Optional   | Optional  | -  |
| Knob Control LED Display (Visio Display)   |       | Optional   | -   | -  |
| Smart LCD (Ready Cook)   |       | Optional   | -   | -  |
| Monochrome LCD   |       | Optional   | -   | -  |
| Baking Tray (Shallow Tray)   |       | Optional   | 1   | Optional   |
| Roasting Tray (Deep Tray)  |       | 1  | Optional  | 1  |
| Glass Tray   |       | Optional   | Optional  | Optional   |
| Chromed Grid with Stoper   |       | 1  | 1   | 1  |
| Wire grid for deep tray  |       | Optional   | Optional  | Optional   |
| Broil Pan with Handle Set  |       | Optional   | Optional  | Optional   |
| Self Cleaning Period   | hours | -  | 1,5 / 1   | -  |
| Energy Consumption during Self Cleaning Function   | kwh   | -  | 2,6   | -  |
| Available Colours  |       |  |   |  |
| White  |       | Standard   | Standard  | Standard   |
| Black  |       | Optional   | Optional  | Optional   |
| Stainless Steel  |       | Optional   | Optional  | Optional   |
| Terre De France  |       | Optional   | Optional  | Optional   |
| Mink   |       | Optional   | Optional  | Optional   |
| Claret Red   |       | Optional   | Optional  | Optional   |
| Cream  |       | Optional   | Optional  | Optional   |
| Rustik (Black / White / Cream)   |       | Optional   | Optional  | Optional   |
| Silver   |       | Optional   | Optional  | Optional   |
| Control Panel  |       |  |   |  |
| Metal  |       | Standard   | Standard  | Standard   |
| Glass  |       | Optional   | Optional  | Optional   |
| Various Types of Inox Add-on on Glass Control Panel  |       | Optional   | Optional  | Optional   |
| Oven Door  |       |  |   |  |
| Full outer glass and small inner glass with metal frame (4 glasses)                          |       | -  | Standard  | -  |
| Full inner glass and full glass front face (4 glasses) Oven Door                             |       | -  | Optional  | -  |
| Full outer glass and Inner metal door (small glass) Oven Door                                |       | Standard   | -   | Standard   |
| Full outer glass and inner glass Oven Door   |       | Optional   | -   | Optional   |
| Full outer glass and full inner glass Oven Door  |       | Optional   | -   | Optional   |
| Cool touch Oven door   |       | Optional   | -   | Optional   |
| Mirror Oven Door Glass   |       | Optional   | -   | Optional   |
| Removable Oven Door  |       | Standard   | Standard  | Standard   |
| Various Types of Inox Add-on on Oven Door Glass  |       | Optional   | Optional  | Optional   |
| Child Lock on Oven Door  |       | Optional   | Standard (Electromechanic)                                    | Optional   |
| Others   |       |  |   |  |
| Total Power (Depends on Model) Maximum   | kW    | 3,1  | 2,6   | 3,1  |
| Tangential Cooling Fan (in case of built-in oven with cooling fan)                           | W     | 11,5   | 23 / 40 (double level)  | 11,5   |
| Tangential Cooling Fan Noise Level   | dBA   | 49   | 53 (for pyrolytic function) 49 (for cooking function)         | 49   |
| Voltage  | V     | 230  | 230   | 230  |
| Electric Cooker Energy Rating (Depends on Model)   |       | A++/A+ / A / B   | A / B   | A / B  |
| Cavity Insulation  |       | White / Yellow   | White (with Aluminum foil)                                    | White / Yellow   |
| Pop-in / Pop-out Knob  |       | Optional   | Optional  | Optional   |
| Hob controls on Control Panel (in case of polyvalente oven)                                  |       | Standard   | -   | Standard   |
| Main Cable   |       | Standard   | Standard  | Standard   |
| Shrink Packed Product Dimensions (Width / Depth / Height)                                    | mm    | 680 x 630 x 640  | 680 x 630 x 640   | 680 x 630 x 640  |
| Carton Box Packaging   |       | Optional   | Optional  | Optional   |
| RoHS Compliance  |       | Standard   | Standard  | Standard   |
| CE Compliance  |       | Standard   | Standard  | Standard   |
| Net Weight (Depends on Model) Maximum  | kg    | 35   | 34  | 35   |
| Gross Weight (Depends on Model) Maximum  | kg    | 37,7   | 36,2  | 37,7   |
| Container Loading Quantity (20 ft Container)   | pcs   | 81   | 81  | 81   |
| Container Loading Quantity (40 ft Container)   | pcs   | 162  | 162   | 162  |
| Container Loading Quantity (40 ft HC Container)  | pcs   | 216  | 216   | 216  |

| 60cm BUILT-IN OVEN SPECIFICATION SHEET   |     | 60cm ELECTRIC BUILT-IN OVEN (75L)          | 60cm ELECTRIC POLYVALENTE BUILT-IN OVEN (75L) |
|--|-----|--|---|
| Dimensions   |     |  |   |
| Product Height   | mm  | 595  | 595   |
| Product Width  | mm  | 595  | 595   |
| Product Depth (with / without Control Panel)   | mm  | 575 / 550                                  | 575 / 550                                     |
| Cabinet Dimensions (Width / Height / Depth) -If control panel located inside the cabinet     | mm  | 600 / 600 / 590                            | 600 / 600 / 580                               |
| Cabinet Dimensions (Width / Height / Depth) -If control panel not located inside the cabinet | mm  | 560 / 590 / 555                            | 560 / 580 / 555                               |
| Oven Features  |     |  |   |
| Oven Type  |     | Electric                                   | Electric                                      |
| Oven Volume (without/with fan)   | lt  | 80 / 73(mold runners) - 85 / 78(wire rack) | 80 / 73(mold runners) - 85 / 78(wire rack)    |
| Cavity Dimensions (without/with fan)   | mm  | 450 x 451 x 392 / 450 x 413x 392           | 450 x 451 x 392 / 450 x 413x 392              |
| Oven Light (25W)   |     | Standard                                   | Standard                                      |
| Easy to Clean Enamel   |     | Standard                                   | Standard                                      |
| Catalytic Enamel Panels (Left, right and rear)   |     | Optional                                   | Optional                                      |
| Wire Side Racks  |     | Optional                                   | Optional                                      |
| Telescopic Rails (1 or 2 racks)  |     | Optional                                   | Optional                                      |
| Top Heating Element  | W   | 1200                                       | 1200  |
| Bottom Heating Element   | W   | 1100                                       | 1100  |
| Thermostat   |     | Standard                                   | Standard                                      |
| Grill (Thermostatic)   | W   | 1400                                       | 1400  |
| Double Grill (Thermostatic)  | W   | 2600                                       | 2600  |
| Fan  | W   | 23   | 23  |
| Fan with Ring Heating Element  | W   | 2000                                       | 2000  |
| Automatic Boost Function   |     | available for some control unit            | available for some control unit               |
| Turnspit   |     | Optional                                   | Optional                                      |
| Oven Functions   |     | Up to 9                                    | Up to 9                                       |
| Thermostat Operation Indicator Light   |     | Standard                                   | Standard                                      |
| Oven Operation Indicator Light   |     | Standard                                   | -   |
| Hotplate Operation Indicator Light (in case of polyvalente oven)                             |     | -  | Standard                                      |
| Minute Minder  |     | Optional                                   | Optional                                      |
| Mechanical Timer   |     | Optional                                   | Optional                                      |
| Digital Clock  |     | Optional                                   | Optional                                      |
| Digital Programmer   |     | Optional                                   | Optional                                      |
| Digital Programmer with touch interface  |     | Optional                                   | Optional                                      |
| Knob Control LED Display and Touch Interface (Visio Touch)                                   |     | Optional                                   | -   |
| Knob Control LED Display (Visio Display)   |     | Optional                                   | -   |
| Smart LCD (Ready Cook)   |     | Optional                                   | -   |
| Monochrome LCD   |     | Optional                                   | -   |
| Baking Tray (Shallow Tray)   |     | Optional                                   | Optional                                      |
| Roasting Tray (Deep Tray)  |     | 1  | 1   |
| Glass Tray   |     | Optional                                   | Optional                                      |
| Chromed Grid with Stoper   |     | 1  | 1   |
| Wire grid for deep tray  |     | Optional                                   | Optional                                      |
| Broil Pan with Handle Set  |     | Optional                                   | Optional                                      |
| Available Colours  |     |  |   |
| White  |     | Standard                                   | Standard                                      |
| Black  |     | Optional                                   | Optional                                      |
| Stainless Steel  |     | Optional                                   | Optional                                      |
| Terre De France  |     | Optional                                   | Optional                                      |
| Mink   |     | Optional                                   | Optional                                      |
| Claret Red   |     | Optional                                   | Optional                                      |
| Cream  |     | Optional                                   | Optional                                      |
| Rustik (Black / White / Cream)   |     | Optional                                   | Optional                                      |
| Silver   |     | Optional                                   | Optional                                      |
| Control Panel  |     |  |   |
| Metal  |     | Standard                                   | Standard                                      |
| Glass  |     | Optional                                   | Optional                                      |
| Various Types of Inox Add-on on Glass Control Panel  |     | Optional                                   | Optional                                      |
| Oven Door  |     |  |   |
| Full outer glass and full inner glass Oven Door  |     | Standard                                   | Standard                                      |
| Mirror Oven Door Glass   |     | Optional                                   | Optional                                      |
| Removable Oven Door  |     | Standard                                   | Standard                                      |
| Various Types of Inox Add-on on Oven Door Glass  |     | Optional                                   | Optional                                      |
| Others   |     |  |   |
| Total Power (Depends on Model) Maximum   | kW  |  |   |
| Tangential Cooling Fan (in case of built-in oven with cooling fan)                           | W   | 11,5                                       | 11,5  |
| Tangential Cooling Fan Noise Level   | dBA | 49   | 49  |
| Voltage  | V   | 230  | 230   |
| Electric Cooker Energy Rating (Depends on Model)   |     | A-B  | A-B   |
| Cavity Insulation  |     | White / Yellow                             | White / Yellow                                |
| Pop-in / Pop-out Knob  |     | Optional                                   | Optional                                      |
| Hob controls on Control Panel (in case of combi oven)  |     | Standard                                   | Standard                                      |
| Main Cable   |     | Standard                                   | Standard                                      |
| Shrink Packed Product Dimensions (Width / Depth / Height)                                    | mm  | 680 x 630 x 640                            | 680 x 630 x 640                               |
| Carton Box Packaging   |     | Optional                                   | Optional                                      |
| RoHS Compliance  |     | Standard                                   | Standard                                      |
| CE Compliance  |     | Standard                                   | Standard                                      |
| Net Weight (Depends on Model) Maximum  | kg  | 36   | 36  |
| Gross Weight (Depends on Model) Maximum  | kg  | 38,2                                       | 38,2  |
| Container Loading Quantity (20 ft Container)   | pcs | 81   | 81  |
| Container Loading Quantity (40 ft Container)   | pcs | 162  | 162   |
| Container Loading Quantity (40 ft HC Container)  | pcs | 216  | 216   |

| BUILT-IN / TABLE-TOP HOB SPECIFICATION SHEET   |     | BI Gas/Combined Hobs        |                             |                             |                             |                             |                   |                             |                             |
|--|-----|-----------------------------|-----------------------------|-----------------------------|-----------------------------|-----------------------------|-------------------|-----------------------------|-----------------------------|
|  |     | 60 CM<br>Flat / Surface     | 60 CM<br>Extenda            | 60 CM<br>Classic            | 60 CM<br>Model I            | 60 CM<br>PlusX              | 60 CM<br>Division | 70 CM<br>Model I            | 70 CM<br>PlusX              |
| Available Colours  |     |                             |                             |                             |                             |                             |                   |                             |                             |
| White  |     | Standard                    | Standard                    | Standard                    | Standard                    | Standard                    | -                 | Standard                    | Standard                    |
| Brown  |     | Optional                    | Optional                    | Optional                    | Optional                    | Optional                    | -                 | Optional                    | Optional                    |
| Terre de France  |     | Optional                    | Optional                    | Optional                    | Optional                    | Optional                    | -                 | Optional                    | Optional                    |
| Black  |     | Optional                    | Optional                    | Optional                    | Optional                    | Optional                    | -                 | Optional                    | Optional                    |
| Dark Green   |     | Optional                    | Optional                    | Optional                    | Optional                    | Optional                    | -                 | Optional                    | Optional                    |
| Stainless Steel  |     | Optional                    | Optional                    | Optional                    | Optional                    | Optional                    | Standard          | Optional                    | Optional                    |
| Product Dimensions   |     |                             |                             |                             |                             |                             |                   |                             |                             |
| Height (max., varies from model to model)  | mm  | 40                          | 40                          | 40                          | 39,5                        | 42                          | 42                | 39,5                        | 42                          |
| Width  | mm  | 580                         | 580                         | 580                         | 590                         | 580                         | 580               | 680                         | 700                         |
| Depth (max., do not include gas connection detail)   | mm  | 510                         | 510                         | 510                         | 515                         | 515                         | 510               | 515                         | 515                         |
| Cut-out Dimensions   |     |                             |                             |                             |                             |                             |                   |                             |                             |
| Width  | mm  | 560                         | 560                         | 560                         | 560                         | 560                         | 560               | 560                         | 560                         |
| Depth  | mm  | 490                         | 490                         | 490                         | 490                         | 490                         | 490               | 490                         | 490                         |
| Hob Features   |     |                             |                             |                             |                             |                             |                   |                             |                             |
| Hob  |     | Enamel /<br>Stainless Steel | Enamel /<br>Stainless Steel | Enamel /<br>Stainless Steel | Enamel /<br>Stainless Steel | Enamel /<br>Stainless Steel | Stainless Steel   | Enamel /<br>Stainless Steel | Enamel /<br>Stainless Steel |
| Rapid Gas Burner Ø10cm   | W   | 3000                        | 3000                        | 3000                        | 3000                        | 3000                        | 3000              | 3000                        | 3000                        |
| Semi-rapid Gas Burner Ø7.5cm   | W   | 1750                        | 1750                        | 1750                        | 1750                        | 1750                        | 1750              | 1750                        | 1750                        |
| Auxiliary Gas Burner Ø5.5cm  | W   | 1000                        | 1000                        | 1000                        | 1000                        | 1000                        | 1000              | 1000                        | 1000                        |
| Wok (Triple Flame) Gas Burner Mono Ø14cm   | W   | 3800                        | 3800                        | 3600                        | 3600                        | -                           | -                 | 3600                        | 3600                        |
| Wok (Triple Flame) Gas Burner Dual Ø14cm   | W   | -                           | -                           | -                           | -                           | -                           | -                 | -                           | -                           |
| Wok (Triple Flame) Gas Burner Ø11cm  | W   | -                           | -                           | -                           | -                           | 3200                        | -                 | -                           | -                           |
| Ø 145 mm Hotplate  | W   | -                           | -                           | 1000                        | 1000                        | 1000                        | -                 | 1000                        | 1000                        |
| Ø 180 mm Hotplate  | W   | 1500                        | 1500                        | -                           | -                           | -                           | -                 | -                           | -                           |
| Ø 145 mm Rapid Hotplate  | W   | -                           | -                           | -                           | -                           | -                           | -                 | -                           | -                           |
| Ø 180 mm Rapid Hotplate  | W   | -                           | -                           | -                           | -                           | -                           | -                 | -                           | -                           |
| Ø145 mm Highlite Element   | W   | -                           | -                           | -                           | -                           | -                           | -                 | -                           | -                           |
| Ø180 mm Highlite Element   | W   | -                           | -                           | -                           | -                           | -                           | -                 | -                           | -                           |
| Ø210 mm Highlite Element   | W   | -                           | -                           | -                           | -                           | -                           | -                 | -                           | -                           |
| Ø180 mm Dual Highlite Element  | W   | -                           | -                           | -                           | -                           | -                           | -                 | -                           | -                           |
| Ø145 mm Oval Highlite Element  | W   | -                           | -                           | -                           | -                           | -                           | -                 | -                           | -                           |
| Ø210 mm Dual Highlite Element  | W   | -                           | -                           | -                           | -                           | -                           | -                 | -                           | -                           |
| Ø210 mm Triple Highlite Element  | W   | -                           | -                           | -                           | -                           | -                           | -                 | -                           | -                           |
| Ø290 mm Dual/Triple Highlite Element   | W   | -                           | -                           | -                           | -                           | -                           | -                 | -                           | -                           |
| Ø 160 mm Induction Zone(Serie 1 and Serie 2)   | W   | -                           | -                           | -                           | -                           | -                           | -                 | -                           | -                           |
| Ø 200 mm Induction Zone(Serie 1)   | W   | -                           | -                           | -                           | -                           | -                           | -                 | -                           | -                           |
| Ø 210 mm Induction Zone(Serie 2)   | W   | -                           | -                           | -                           | -                           | -                           | -                 | -                           | -                           |
| Ø 250 mm Induction Zone(Serie 1)   | W   | -                           | -                           | -                           | -                           | -                           | -                 | -                           | -                           |
| Ø 290 mm Induction Zone(Serie 2)   | W   | -                           | -                           | -                           | -                           | -                           | -                 | -                           | -                           |
| Boost Function   |     | -                           | -                           | -                           | -                           | -                           | -                 | -                           | -                           |
| Pot Dedection  |     | -                           | -                           | -                           | -                           | -                           | -                 | -                           | -                           |
| Automatic Heatup   |     | -                           | -                           | -                           | -                           | -                           | -                 | -                           | -                           |
| Timer function for vitro ceramic hobs (If touch control with some hob configuration selected)    |     | -                           | -                           | -                           | -                           | -                           | -                 | -                           | -                           |
| Mode function for induction ceramic hobs (If touch control with some hob configuration selected) |     | -                           | -                           | -                           | -                           | -                           | -                 | -                           | -                           |
| Bridge zone for induction ceramic hobs (If touch control with some hob configuration selected)   |     | -                           | -                           | -                           | -                           | -                           | -                 | -                           | -                           |
| Child Lock for vitro ceramic hobs (If touch control selected)                                    |     | -                           | -                           | -                           | -                           | -                           | -                 | -                           | -                           |
| Mechanical Child Lock (Main Switch)  |     | -                           | -                           | -                           | -                           | -                           | -                 | -                           | -                           |
| Hot Surface Indicator Light  |     | -                           | -                           | -                           | -                           | -                           | -                 | -                           | -                           |
| Hotplate Operation Indicator Light   |     | Standard                    | Standard                    | Standard                    | Standard                    | Standard                    | -                 | Standard                    | Standard                    |
| Side Knob Control  |     | Standard                    | Standard                    | Standard                    | -                           | -                           | -                 | -                           | -                           |
| Side Touch Control   |     | -                           | -                           | -                           | -                           | -                           | -                 | -                           | -                           |
| Front Knob Control   |     | -                           | -                           | -                           | Standard                    | Standard                    | -                 | Standard                    | Standard                    |
| Double Side Front Control  |     | -                           | -                           | -                           | -                           | -                           | Standard          | -                           | -                           |
| Front Triangular Touch Control   |     | -                           | -                           | -                           | -                           | -                           | -                 | -                           | -                           |
| Front Slider Touch Control   |     | -                           | -                           | -                           | -                           | -                           | -                 | -                           | -                           |
| Front Touch Control  |     | -                           | -                           | -                           | -                           | -                           | -                 | -                           | -                           |
| Bevelled Edges   |     | -                           | -                           | -                           | -                           | -                           | -                 | -                           | -                           |
| Logo   |     | Standard                    | Standard                    | Standard                    | Standard                    | Standard                    | Standard          | Standard                    | Standard                    |
| Special Decoration on Glass  |     | -                           | -                           | -                           | -                           | -                           | -                 | -                           | -                           |
| Vitroceramic Glass Artwork   |     | -                           | -                           | -                           | -                           | -                           | -                 | -                           | -                           |
| Inox Frame   |     | -                           | -                           | -                           | -                           | -                           | -                 | -                           | -                           |
| Stainless Steel Burner Pan   |     | -                           | -                           | -                           | -                           | -                           | -                 | -                           | -                           |
| Table Top Installation (not built-in)  |     | Optional                    | Optional                    | Optional                    | -                           | -                           | -                 | -                           | -                           |
| Glass Lid  |     | -                           | -                           | -                           | -                           | -                           | -                 | -                           | -                           |
| Burner Safety Valves   |     | Standard                    | Standard                    | Standard                    | Standard                    | Standard                    | Standard          | Standard                    | Standard                    |
| Button Ignition  |     | Optional                    | Optional                    | Optional                    | Optional                    | -                           | -                 | Optional                    | -                           |
| One-touch-Ignition through knobs   |     | Optional                    | Optional                    | Optional                    | Optional                    | Optional                    | Standard          | Optional                    | Optional                    |
| Enamel Pan Supports  |     | Standard                    | Standard                    | Standard                    | Standard                    | Standard                    | -                 | Standard                    | Standard                    |
| Cast Iron Pan Supports   |     | Optional                    | Optional                    | -                           | Optional                    | Optional                    | Standard          | Optional                    | Optional                    |
| Cast Iron Burner Caps  |     | Optional                    | Optional                    | -                           | Optional                    | Optional                    | Optional          | Optional                    | Optional                    |
| Coffee Adaptor   |     | Optional                    | Optional                    | Optional                    | Optional                    | Optional                    | Optional          | Optional                    | Optional                    |
| Wok Adaptor  |     | Optional                    | Optional                    | Optional                    | Optional                    | Optional                    | -                 | Optional                    | Optional                    |
| Vitroceramic Glass Cleaning Spatula  |     | -                           | -                           | -                           | -                           | -                           | -                 | -                           | -                           |
| Gas Conversion Kit   |     | Standard                    | Standard                    | Standard                    | Standard                    | Standard                    | Standard          | Standard                    | Standard                    |
| Others   |     |                             |                             |                             |                             |                             |                   |                             |                             |
| Total Gas Power (Depends on Model) Maximum   | kW  | 8,3                         | 8,3                         | 8,1                         | 8,1                         | 7,7                         | 7,5               | 11,1                        | 11,1                        |
| Total Electric Power (Depends on Model) Maximum  | kW  | 1,5                         | 1,5                         | 1                           | 1                           | 1                           | -                 | 1                           | 1                           |
| Voltage  | V   | 230V~                       | 230V~                       | 230V~                       | 230V~                       | 230V~                       | 230V~             | 230V~                       | 230V~                       |
| RoHS Compliance  |     | Standard                    | Standard                    | Standard                    | Standard                    | Standard                    | Standard          | Standard                    | Standard                    |
| CE Compliance  |     | Standard                    | Standard                    | Standard                    | Standard                    | Standard                    | Standard          | Standard                    | Standard                    |
| Carton Box Packaging   |     | Standard                    | Standard                    | Standard                    | Standard                    | Standard                    | Standard          | Standard                    | Standard                    |
| Packed Product Dimensions (WxDxH)  | mm  | 626 x 580 x 140             | x                           | 626 x 560 x 130             | 641 x 576 x 161             | x                           | x                 | 731 x 576 x 161             | x                           |
| Loading Quantity 20 ft (Wrapped Carton)  | pcs | 576                         | x                           | 612                         | 448                         | x                           | x                 | 420                         | x                           |
| Loading Quantity 40 ft (Wrapped Carton)  | pcs | 1216                        | x                           | 1292                        | 1008                        | x                           | x                 | 896                         | x                           |
| Loading Quantity 40 HC (Wrapped Carton)  | pcs | 1368                        | x                           | 1444                        | 1152                        | x                           | x                 | 1024                        | x                           |
| Packed Product Dimensions (WxDxH) Box  | mm  | 640 x 584 x 152             | 647 x 582 x 164             | 635 x 564 x 142             | x                           | 647 x 582 x 164             | 647 x 582 x 164   | x                           | 769 x 582 x 164             |
| Loading Quantity 20 ft (Carton Box)  | pcs | 405                         | 378                         | 576                         | x                           | 378                         | 378               | x                           | 378                         |
| Loading Quantity 40 ft (Carton Box)  | pcs | 900                         | 840                         | 1152                        | x                           | 840                         | 840               | x                           | 840                         |
| Loading Quantity 40 HC (Carton Box)  | pcs | 1020                        | 960                         | 1296                        | x                           | 960                         | 960               | x                           | 960                         |
| Net Weight (Depends on Model) Maximum  | kg  | 9                           | 9,5                         | 6,6                         | 9,8                         | 9,5                         | 11                | 10,7                        | 12,5                        |
| Gross Weight (Depends on Model) Maximum  | kg  | 9,75                        | 10,5                        | 7,5                         | 10,6                        | 10,5                        | 12                | 11,6                        | 13,5                        |



OVENS&HOBS//SPECIFICATIONS

| BUILT-IN / TABLE-TOP HOB SPECIFICATION SHEET   |     | BI Gas Securit Hobs       |                       |                  |                 |                   |                  |                 |                 |
|--|-----|---------------------------|-----------------------|------------------|-----------------|-------------------|------------------|-----------------|-----------------|
|  |     | 60 CM<br>Securit II       | 60 CM<br>Trio         | 60 CM<br>Model I | 60 CM<br>PlusX  | 60 CM<br>Division | 70 CM<br>Model I | 70 CM<br>PlusX  | 90 CM           |
| Available Colours  |     |                           |                       |                  |                 |                   |                  |                 |                 |
| White  |     | Optional                  | Optional              | Optional         | Optional        | -                 | Optional         | Optional        | Optional        |
| Brown  |     | Optional                  | Optional              | Optional         | Optional        | -                 | Optional         | Optional        | Optional        |
| Terre de France  |     | Optional                  | Optional              | Optional         | Optional        | -                 | Optional         | Optional        | Optional        |
| Black  |     | Standard                  | Standard              | Standard         | Standard        | Standard          | Standard         | Standard        | Standard        |
| Dark Green   |     | Optional                  | Optional              | Optional         | Optional        | -                 | Optional         | Optional        | Optional        |
| Stainless Steel  |     | -                         | -                     | -                | -               | -                 | -                | -               | -               |
| Product Dimensions   |     |                           |                       |                  |                 |                   |                  |                 |                 |
| Height (max.,varies from model to model)   | mm  | 44                        | 44                    | 39,5             | 44              | 44                | 39,5             | 44              | 47              |
| Width  | mm  | 594                       | 594                   | 590              | 594             | 594               | 680              | 700             | 882             |
| Depth (max., do not include gas connection detail)   | mm  | 523                       | 523                   | 515              | 523             | 523               | 515              | 520             | 520             |
| Cut-out Dimensions   |     |                           |                       |                  |                 |                   |                  |                 |                 |
| Width  | mm  | 560                       | 560                   | 560              | 560             | 560               | 560              | 560             | 850             |
| Depth  | mm  | 490                       | 490                   | 490              | 490             | 490               | 490              | 490             | 480             |
| Hob Features   |     |                           |                       |                  |                 |                   |                  |                 |                 |
| Hob  |     | Securit                   | Securit               | Securit          | Securit         | Securit           | Securit          | Securit         | Securit         |
| Rapid Gas Burner Ø10cm   | W   | 3000                      | 3000                  | 3000             | 3000            | 3000              | 3000             | 3000            | 3000            |
| Semi-rapid Gas Burner Ø7,5cm   | W   | 1750                      | 1750                  | 1750             | 1750            | 1750              | 1750             | 1750            | 1750            |
| Auxiliary Gas Burner Ø5,5cm  | W   | 1000                      | 1000                  | 1000             | 1000            | 1000              | 1000             | 1000            | 1000            |
| Wok (Triple Flame) Gas Burner Mono Ø14cm   | W   | 3800                      | 3600                  | 3800             | 3600            | -                 | 3800             | 3600            | 4500            |
| Wok (Triple Flame) Gas Burner Dual Ø14cm   | W   | -                         | -                     | -                | -               | -                 | -                | -               | 4500            |
| Wok (Triple Flame) Gas Burner Ø11cm  | W   | -                         | -                     | -                | -               | -                 | -                | -               | -               |
| Ø 145 mm Hotplate  | W   | -                         | -                     | -                | 1000            | -                 | -                | -               | -               |
| Ø 180 mm Hotplate  | W   | -                         | -                     | -                | -               | -                 | -                | -               | -               |
| Ø 145 mm Rapid Hotplate  | W   | -                         | -                     | -                | -               | -                 | -                | -               | -               |
| Ø 180 mm Rapid Hotplate  | W   | -                         | -                     | -                | -               | -                 | -                | -               | -               |
| Ø145 mm Highlite Element   | W   | -                         | -                     | -                | -               | -                 | -                | -               | -               |
| Ø180 mm Highlite Element   | W   | -                         | -                     | -                | -               | -                 | -                | -               | -               |
| Ø210 mm Highlite Element   | W   | -                         | -                     | -                | -               | -                 | -                | -               | -               |
| Ø180 mm Dual Highlite Element  | W   | -                         | -                     | -                | -               | -                 | -                | -               | -               |
| Ø145 mm Oval Highlite Element  | W   | -                         | -                     | -                | -               | -                 | -                | -               | -               |
| Ø210 mm Dual Highlite Element  | W   | -                         | -                     | -                | -               | -                 | -                | -               | -               |
| Ø210 mm Triple Highlite Element  | W   | -                         | -                     | -                | -               | -                 | -                | -               | -               |
| Ø290 mm Dual/Triple Highlite Element   | W   | -                         | -                     | -                | -               | -                 | -                | -               | -               |
| Ø 160 mm Induction Zone(Serie 1 and Serie 2)   | W   | -                         | -                     | -                | -               | -                 | -                | -               | -               |
| Ø 200 mm Induction Zone(Serie 1)   | W   | -                         | -                     | -                | -               | -                 | -                | -               | -               |
| Ø 210 mm Induction Zone(Serie 2)   | W   | -                         | -                     | -                | -               | -                 | -                | -               | -               |
| Ø 250 mm Induction Zone(Serie 1)   | W   | -                         | -                     | -                | -               | -                 | -                | -               | -               |
| Ø 290 mm Induction Zone(Serie 2)   | W   | -                         | -                     | -                | -               | -                 | -                | -               | -               |
| Boost Function   |     | -                         | -                     | -                | -               | -                 | -                | -               | -               |
| Pot Dedection  |     | -                         | -                     | -                | -               | -                 | -                | -               | -               |
| Automatic Heatup   |     | -                         | -                     | -                | -               | -                 | -                | -               | -               |
| Timer function for vitro ceramic hobs (If touch control with some hob configuration selected)    |     | -                         | -                     | -                | -               | -                 | -                | -               | -               |
| Mode function for induction ceramic hobs (If touch control with some hob configuration selected) |     | -                         | -                     | -                | -               | -                 | -                | -               | -               |
| Bridge zone for induction ceramic hobs (If touch control with some hob configuration selected)   |     | -                         | -                     | -                | -               | -                 | -                | -               | -               |
| Child Lock for vitro ceramic hobs (If touch control selected)                                    |     | -                         | -                     | -                | -               | -                 | -                | -               | -               |
| Mechanical Child Lock (Main Switch)  |     | -                         | -                     | -                | -               | -                 | -                | -               | Optional        |
| Hot Surface Indicator Light  |     | -                         | -                     | -                | -               | -                 | -                | -               | -               |
| Hotplate Operation Indicator Light   |     | -                         | -                     | Standard         | Standard        | -                 | -                | -               | -               |
| Side Knob Control  |     | Standard                  | Standard              | -                | -               | -                 | -                | -               | -               |
| Side Touch Control   |     | -                         | -                     | -                | -               | -                 | -                | -               | -               |
| Front Knob Control   |     | -                         | -                     | Standard         | Standard        | -                 | Standard         | Standard        | Standard        |
| Double Side Front Control  |     | -                         | -                     | -                | -               | Standard          | -                | -               | -               |
| Front Triangular Touch Control   |     | -                         | -                     | -                | -               | -                 | -                | -               | -               |
| Front Slider Touch Control   |     | -                         | -                     | -                | -               | -                 | -                | -               | -               |
| Front Touch Control  |     | -                         | -                     | -                | -               | -                 | -                | -               | -               |
| Bevelled Edges   |     | -                         | -                     | -                | -               | -                 | -                | -               | Optional        |
| Logo   |     | Optional                  | Optional              | Standard         | Standard        | Standard          | Standard         | Standard        | Standard        |
| Special Decoration on Glass  |     | Optional                  | Optional              | -                | -               | -                 | -                | -               | -               |
| Vitroceraic Glass Artwork  |     | -                         | -                     | -                | -               | -                 | -                | -               | -               |
| Inox Frame   |     | -                         | -                     | Standard         | -               | -                 | Standard         | -               | Optional        |
| Stainless Steel Burner Pan   |     | Optional                  | Optional              | Optional         | Optional        | -                 | Optional         | Optional        | Optional        |
| Table Top Installation (not built-in)  |     | -                         | -                     | -                | -               | -                 | -                | -               | -               |
| Glass Lid  |     | -                         | -                     | -                | -               | -                 | -                | -               | -               |
| Burner Safety Valves   |     | Standard                  | Standard              | Standard         | Standard        | Standard          | Standard         | Standard        | Standard        |
| Button Ignition  |     | Optional                  | Optional              | Optional         | -               | -                 | Optional         | -               | -               |
| One-touch-Ignition through knobs   |     | Optional                  | Optional              | Optional         | Optional        | Standard          | Optional         | Optional        | Standard        |
| Enamel Pan Supports  |     | Standard                  | Standard              | Standard         | Standard        | -                 | Standard         | Standard        | -               |
| Cast Iron Pan Supports   |     | Optional                  | Optional              | Optional         | Optional        | Standard          | Optional         | Optional        | Standard        |
| Cast Iron Burner Caps  |     | Optional                  | Optional              | Optional         | Optional        | Optional          | Optional         | Optional        | Standard        |
| Coffee Adaptor   |     | Optional                  | Optional              | Optional         | Optional        | Optional          | Optional         | Optional        | Optional        |
| Wok Adaptor  |     | Optional                  | Optional              | Optional         | Optional        | -                 | Optional         | Optional        | Optional        |
| Vitroceraic Glass Cleaning Spatula   |     | -                         | -                     | -                | -               | -                 | -                | -               | -               |
| Gas Conversion Kit   |     | Standard                  | Standard              | Standard         | Standard        | Standard          | Standard         | Standard        | Optional        |
| Others   |     |                           |                       |                  |                 |                   |                  |                 |                 |
| Total Gas Power (Depends on Model) Maximum   | kW  | 8,3                       | 8,1                   | 8,3              | 8,1             | 7,5               | 11,3             | 11,1            | 12              |
| Total Electric Power (Depends on Model) Maximum  | kW  | -                         | -                     | -                | 1               | -                 | -                | -               | -               |
| Voltage  | V   | 230V-                     | 230V-                 | 230V-            | 230V-           | 230V-             | 230V-            | 230V-           | 230V-           |
| RoHS Compliance  |     | Standard                  | Standard              | Standard         | Standard        | Standard          | Standard         | Standard        | Standard        |
| CE Compliance  |     | Standard                  | Standard              | Standard         | Standard        | Standard          | Standard         | Standard        | Standard        |
| Carton Box Packaging   |     | Standard                  | Standard              | Standard         | Standard        | Standard          | Standard         | Standard        | Standard        |
| Packed Product Dimensions (WxDxH)  | mm  | 622 x 580 x 140           | 622 x 580 x 140       | 641 x 576 x 161  | x               | x                 | 731 x 576 x 161  | x               | x               |
| Loading Quantity 20 ft (Wrapped Carton)  |     | 576 (without wok burner)  | 432 (with wok burner) | 576              | 448             | x                 | x                | 420             | x               |
| Loading Quantity 40 ft (Wrapped Carton)  |     | 1216 (without wok burner) | 912 (with wok burner) | 1216             | 1008            | x                 | x                | 896             | x               |
| Loading Quantity 40 HC (Wrapped Carton)  |     | 1368 (without wok burner) | 912 (with wok burner) | 1368             | 1152            | x                 | x                | 1024            | x               |
| Packed Product Dimensions (WxDxH) Box  | mm  | x                         | x                     | x                | 647 x 582 x 164 | 647 x 582 x 164   | x                | 769 x 582 x 164 | 935 x 582 x 164 |
| Loading Quantity 20 ft (Carton Box)  | pcs | x                         | x                     | x                | 378             | 378               | x                | 378             | 252             |
| Loading Quantity 40 ft (Carton Box)  | pcs | x                         | x                     | x                | 840             | 840               | x                | 840             | 560             |
| Loading Quantity 40 HC (Carton Box)  | pcs | x                         | x                     | x                | 960             | 960               | x                | 960             | 640             |
| Net Weight (Depends on Model) Maximum  | kg  | 9,5                       | 9,5                   | 10,7             | 11,5            | -                 | 13,7             | 13,8            | 20,5            |
| Gross Weight (Depends on Model) Maximum  | kg  | 10,25                     | 10,25                 | 11,13            | 12,5            | -                 | 14,2             | 14,8            | 21,5            |

| BUILT-IN / TABLE-TOP HOB SPECIFICATION SHEET   |     | BI Electric Hobs         |                    | BI Vitro Ceramic Hobs |                                  | BI Induction Ceramic Hobs        |                                  |                  |
|--|-----|--------------------------|--------------------|-----------------------|----------------------------------|----------------------------------|----------------------------------|------------------|
|  |     | 60 CM                    |                    | 60 CM                 | 78 CM                            | 60 CM                            | 78 CM                            | 90CM             |
|  |     | Flat / Surface           |                    | C Serie               | C Serie                          | Vestel Induction                 | Vestel Induction                 | Vestel Induction |
|  |     | Available Colours        |                    |                       |                                  |                                  |                                  |                  |
| White  |     | Standard                 | Optional           | Optional              | Optional                         | Optional                         | Optional                         |                  |
| Brown  |     | Optional                 | -                  | -                     | -                                | -                                | -                                |                  |
| Terre de France  |     | Optional                 | -                  | -                     | -                                | -                                | -                                |                  |
| Black  |     | Optional                 | Standard           | Standard              | Standard                         | Standard                         | Standard                         |                  |
| Dark Green   |     | Optional                 | -                  | -                     | -                                | -                                | -                                |                  |
| Stainless Steel  |     | Optional                 | -                  | -                     | -                                | -                                | -                                |                  |
|  |     | Product Dimensions       |                    |                       |                                  |                                  |                                  |                  |
| Height (max., varies from model to model)  | mm  | 40                       | 41- 47,5           | 41                    | 56                               | 56                               | 56                               |                  |
| Width  | mm  | 580                      | 590                | 780                   | 590                              | 590                              | 890                              |                  |
| Depth (max., do not include gas connection detail)   | mm  | 510                      | 520                | 520                   | 520                              | 520                              | 520                              |                  |
|  |     | Cut-out Dimensions       |                    |                       |                                  |                                  |                                  |                  |
| Width  | mm  | 560                      | 560                | 750                   | 560                              | 750                              | 860                              |                  |
| Depth  | mm  | 490                      | 490                | 490                   | 490                              | 490                              | 490                              |                  |
|  |     | Hob Features             |                    |                       |                                  |                                  |                                  |                  |
| Hob  |     | Enamel / Stainless Steel | Vitro Ceramic      | Vitro Ceramic         | Induction Ceramic                | Induction Ceramic                | Induction Ceramic                |                  |
| Rapid Gas Burner Ø10cm   | W   | Enamel / Stainless Steel | Vitro Ceramic      | Vitro Ceramic         | Induction Ceramic                | Induction Ceramic                | Induction Ceramic                |                  |
| Semi-rapid Gas Burner Ø7.5cm   | W   | -                        | -                  | -                     | -                                | -                                | -                                |                  |
| Auxiliary Gas Burner Ø5.5cm  | W   | -                        | -                  | -                     | -                                | -                                | -                                |                  |
| Wok (Triple Flame) Gas Burner Mono Ø14cm   | W   | -                        | -                  | -                     | -                                | -                                | -                                |                  |
| Wok (Triple Flame) Gas Burner Dual Ø14cm   | W   | -                        | -                  | -                     | -                                | -                                | -                                |                  |
| Wok (Triple Flame) Gas Burner Ø11cm  | W   | -                        | -                  | -                     | -                                | -                                | -                                |                  |
| Ø 145 mm Hotplate  | W   | -                        | -                  | -                     | -                                | -                                | -                                |                  |
| Ø 180 mm Hotplate  | W   | 1000                     | -                  | -                     | -                                | -                                | -                                |                  |
| Ø 145 mm Rapid Hotplate  | W   | 1500                     | -                  | -                     | -                                | -                                | -                                |                  |
| Ø 180 mm Rapid Hotplate  | W   | 1500                     | -                  | -                     | -                                | -                                | -                                |                  |
| Ø145 mm Highlite Element   | W   | 2000                     | -                  | -                     | -                                | -                                | -                                |                  |
| Ø180 mm Highlite Element   | W   | -                        | 1200               | 1200                  | -                                | -                                | -                                |                  |
| Ø210 mm Highlite Element   | W   | -                        | 1800               | 1800                  | -                                | -                                | -                                |                  |
| Ø180 mm Dual Highlite Element  | W   | -                        | 2300               | 2300                  | -                                | -                                | -                                |                  |
| Ø145 mm Oval Highlite Element  | W   | -                        | 1700               | 1700                  | -                                | -                                | -                                |                  |
| Ø210 mm Dual Highlite Element  | W   | -                        | 1800               | 1800                  | -                                | -                                | -                                |                  |
| Ø210 mm Triple Highlite Element  | W   | -                        | 2200               | 2200                  | -                                | -                                | -                                |                  |
| Ø290 mm Dual/Triple Highlite Element   | W   | -                        | 2300               | 2300                  | -                                | -                                | -                                |                  |
| Ø 160 mm Induction Zone(Serie 1 and Serie 2)   | W   | -                        | 2700               | -                     | -                                | -                                | -                                |                  |
| Ø 200 mm Induction Zone(Serie 1)   | W   | -                        | -                  | -                     | Nominal 2100 W max. Boost 2500 W | Nominal 2100 W max. Boost 2500 W | Nominal 2100 W max. Boost 2500 W |                  |
| Ø 210 mm Induction Zone(Serie 2)   | W   | -                        | -                  | -                     | Nominal 2100 W max. Boost 2500 W | -                                | -                                |                  |
| Ø 250 mm Induction Zone(Serie 1)   | W   | -                        | -                  | -                     | Nominal 2800 W max. Boost 3500 W | Nominal 2800 W max. Boost 3500 W | Nominal 2800 W max. Boost 3500 W |                  |
| Ø 290 mm Induction Zone(Serie 2)   | W   | -                        | -                  | -                     | Nominal 2800 W max. Boost 3500 W | -                                | -                                |                  |
| Boost Function   |     | -                        | -                  | -                     | Standard                         | Standard                         | Standard                         |                  |
| Pot Dedection  |     | -                        | -                  | -                     | Standard                         | Standard                         | Standard                         |                  |
| Automatic Heatup   |     | -                        | -                  | -                     | -                                | -                                | -                                |                  |
| Timer function for vitro ceramic hobs (If touch control with some hob configuration selected)    |     | -                        | Optional           | Optional              | Optional                         | Optional                         | Standard                         |                  |
| Mode function for induction ceramic hobs (If touch control with some hob configuration selected) |     | -                        | -                  | -                     | Optional                         | Optional                         | -                                |                  |
| Bridge zone for induction ceramic hobs (If touch control with some hob configuration selected)   |     | -                        | -                  | -                     | Optional                         | -                                | -                                |                  |
| Child Lock for vitro ceramic hobs (If touch control selected)                                    |     | -                        | Standard           | Standard              | Standard                         | Standard                         | Standard                         |                  |
| Mechanical Child Lock (Main Switch)  |     | -                        | -                  | -                     | -                                | -                                | -                                |                  |
| Hot Surface Indicator Light  |     | -                        | Standard           | Standard              | Standard                         | Standard                         | Standard                         |                  |
| Hotplate Operation Indicator Light   |     | Standard                 | -                  | -                     | -                                | -                                | -                                |                  |
| Side Knob Control  |     | Standard                 | Standard           | -                     | -                                | -                                | -                                |                  |
| Side Touch Control   |     | -                        | Optional           | -                     | -                                | -                                | -                                |                  |
| Front Knob Control   |     | -                        | -                  | -                     | -                                | -                                | -                                |                  |
| Double Side Front Control  |     | -                        | -                  | -                     | -                                | -                                | -                                |                  |
| Front Triangular Touch Control   |     | -                        | Optional           | Standard              | -                                | -                                | -                                |                  |
| Front Slider Touch Control   |     | -                        | Optional           | Optional              | Optional                         | Optional                         | Optional                         |                  |
| Front Touch Control  |     | -                        | -                  | -                     | Optional                         | Optional                         | Optional                         |                  |
| Bevelled Edges   |     | -                        | Optional           | Optional              | Optional                         | Optional                         | Optional                         |                  |
| Logo   |     | Standard                 | Optional           | Optional              | Optional                         | Optional                         | Optional                         |                  |
| Special Decoration on Glass  |     | -                        | Optional           | Optional              | Optional                         | Optional                         | Optional                         |                  |
| Vitroceraic Glass Artwork  |     | -                        | Slim / Arc / Point | Slim / Arc / Point    | Slim / Plus / Line               | Slim / Plus / Line               | Slim / Plus / Line               |                  |
| Inox Frame   |     | -                        | Optional           | -                     | Optional                         | Optional                         | Optional                         |                  |
| Stainless Steel Burner Pan   |     | -                        | -                  | -                     | -                                | -                                | -                                |                  |
| Table Top Installation (not built-in)  |     | -                        | -                  | -                     | -                                | -                                | -                                |                  |
| Glass Lid  |     | -                        | -                  | -                     | -                                | -                                | -                                |                  |
| Burner Safety Valves   |     | -                        | -                  | -                     | -                                | -                                | -                                |                  |
| Button Ignition  |     | -                        | -                  | -                     | -                                | -                                | -                                |                  |
| One-touch-Ignition through knobs   |     | -                        | -                  | -                     | -                                | -                                | -                                |                  |
| Enamel Pan Supports  |     | -                        | -                  | -                     | -                                | -                                | -                                |                  |
| Cast Iron Pan Supports   |     | -                        | -                  | -                     | -                                | -                                | -                                |                  |
| Cast Iron Burner Caps  |     | -                        | -                  | -                     | -                                | -                                | -                                |                  |
| Coffee Adaptor   |     | -                        | -                  | -                     | -                                | -                                | -                                |                  |
| Wok Adaptor  |     | -                        | -                  | -                     | -                                | -                                | -                                |                  |
| Vitroceraic Glass Cleaning Spatula   |     | -                        | Optional           | Optional              | Optional                         | Optional                         | Optional                         |                  |
| Gas Conversion Kit   |     | -                        | -                  | -                     | -                                | -                                | -                                |                  |
|  |     | Others                   |                    |                       |                                  |                                  |                                  |                  |
| Total Gas Power (Depends on Model) Maximum   | kW  | -                        | -                  | -                     | -                                | -                                | -                                |                  |
| Total Electric Power (Depends on Model) Maximum  | kW  | 6                        | 6,5                | 8,3                   | 7,4                              | 7,4                              | 10,8                             |                  |
| Voltage  | V   | 230V- / 400V 2N-         | 230V- / 400V 3N-   | 230V- / 400V 3N-      | 230V- / 400V 3N-                 | 230V- / 400V 3N-                 | 230V- / 400V 3N-                 |                  |
| RoHS Compliance  |     | Standard                 | Standard           | Standard              | Standard                         | Standard                         | Standard                         |                  |
| CE Compliance  |     | Standard                 | Standard           | Standard              | Standard                         | Standard                         | Standard                         |                  |
| Carton Box Packaging   |     | Standard                 | Standard           | Standard              | Standard                         | Standard                         | Standard                         |                  |
| Packed Product Dimensions (WxDxH)  | mm  | 626 x 580 x 140          | 620 x 578 x 133    | 810 x 578 x 133       | 626 x 581 x 142                  | 816 x 581 x 142                  | 926 x 581 x 142                  |                  |
| Loading Quantity 20 ft (Wrapped Carton)  | pcs | 576                      | 612                | 476                   | 432                              | 336                              | 252                              |                  |
| Loading Quantity 40 ft (Wrapped Carton)  | pcs | 1216                     | 1292               | 952                   | 960                              | 672                              | 560                              |                  |
| Loading Quantity 40 HC (Wrapped Carton)  | pcs | 1368                     | 1444               | 1064                  | 1080                             | 756                              | 560                              |                  |
| Packed Product Dimensions (WxDxH) Box  | mm  | 640 x 584 x 152          | 631 x 580 x 143    | x                     | 643 x 583 x 152                  | x                                | 941 x 583 x 152                  |                  |
| Loading Quantity 20 ft (Carton Box)  | pcs | 405                      | 576                | x                     | 405                              | x                                | 252                              |                  |
| Loading Quantity 40 ft (Carton Box)  | pcs | 900                      | 1152               | x                     | 900                              | x                                | 560                              |                  |
| Loading Quantity 40 HC (Carton Box)  | pcs | 1020                     | 1296               | x                     | 1020                             | x                                | 560                              |                  |
| Net Weight (Depends on Model) Maximum  | kg  | 9,5                      | 9,5                | 10,15                 | 11                               | 12                               | 16                               |                  |
| Gross Weight (Depends on Model) Maximum  | kg  | 10,25                    | 10,25              | 11                    | 12                               | 13                               | 17                               |                  |

OVENS&HOBS // SPECIFICATIONS

| BUILT-IN / TABLE-TOP HOB SPECIFICATION SHEET   | TT Gas/ Comnined/ Gas Securit Hobs |  |  |                          |                 | TT Electric Hobs                               |  |                          |
|--|------------------------------------|--|--|--------------------------|-----------------|--|--|--------------------------|
|  | 60 CM                              | 60 CM  | 60 CM  | 60 CM                    | 60 CM           | 60 CM  | 60 CM  | 60 CM                    |
|  | Flat / Surface                     | Smoothline                                     | New Gen.                                       | PlusX                    | Flat / Surface  | Smoothline                                     | New Gen.                                       |                          |
| Available Colours  |                                    |  |  |                          |                 |  |  |                          |
| White  |                                    | Standard                                       | Standard                                       | Standard                 | Optional        | Standard                                       | Standard                                       | Standard                 |
| Brown  |                                    | Optional                                       | Optional                                       | -                        | Optional        | Optional                                       | Optional                                       | -                        |
| Terre de France  |                                    | Optional                                       | Optional                                       | -                        | Optional        | Optional                                       | Optional                                       | -                        |
| Black  |                                    | Optional                                       | Optional                                       | Optional                 | Standard        | Optional                                       | Optional                                       | Optional                 |
| Dark Green   |                                    | Optional                                       | Optional                                       | -                        | Optional        | Optional                                       | Optional                                       | -                        |
| Stainless Steel  |                                    | Optional                                       | Optional                                       | Optional                 | Optional        | Optional                                       | Optional                                       | Optional                 |
| Product Dimensions   |                                    |  |  |                          |                 |  |  |                          |
| Height (max.,varies from model to model)   | mm                                 | 95,5 - 104,5                                   | 95,5 - 104,5                                   | 95,5 - 104,5             | 104             | 56,5 - 104,5                                   | 56,5 - 104,5                                   | 56,5 - 104,5             |
| Width  | mm                                 | 585  | 585  | 580                      | 597             | 585  | 585  | 585                      |
| Depth (max., do not include gas connection detail)   | mm                                 | 540  | 540  | 540                      | 526             | 540  | 540  | 540                      |
| Cut-out Dimensions   |                                    |  |  |                          |                 |  |  |                          |
| Width  | mm                                 | -  | -  | -                        | -               | -  | -  | -                        |
| Depth  | mm                                 | -  | -  | -                        | -               | -  | -  | -                        |
| Hob Features   |                                    |  |  |                          |                 |  |  |                          |
| Hob  |                                    | Enamel / Stainless Steel                       | Enamel / Stainless Steel                       | Enamel / Stainless Steel | Securit         | Enamel / Stainless Steel                       | Enamel / Stainless Steel                       | Enamel / Stainless Steel |
| Rapid Gas Burner Ø10cm   | W                                  | 3000   | 3000   | 3000                     | 3000            | -  | -  | -                        |
| Semi-rapid Gas Burner Ø7.5cm   | W                                  | 1750   | 1750   | 1750                     | 1750            | -  | -  | -                        |
| Auxiliary Gas Burner Ø5.5cm  | W                                  | 1000   | 1000   | 1000                     | 1000            | -  | -  | -                        |
| Wok (Triple Flame) Gas Burner Mono Ø14cm   | W                                  | 3800   | 3600   | 3600                     | 3600            | -  | -  | -                        |
| Wok (Triple Flame) Gas Burner Dual Ø14cm   | W                                  | -  | -  | -                        | -               | -  | -  | -                        |
| Wok (Triple Flame) Gas Burner Ø11cm  | W                                  | -  | -  | -                        | -               | -  | -  | -                        |
| Ø 145 mm Hotplate  | W                                  | -  | 1000   | -                        | 1000            | 1000   | 1000   | 1000                     |
| Ø 180 mm Hotplate  | W                                  | 1500   | -  | 1500                     | -               | 1500   | 1500   | 1500                     |
| Ø 145 mm Rapid Hotplate  | W                                  | -  | 1500   | -                        | -               | 1500   | 1500   | 1500                     |
| Ø 180 mm Rapid Hotplate  | W                                  | 2000   | -  | 2000                     | -               | 2000   | 2000   | 2000                     |
| Ø145 mm Highlite Element   | W                                  | -  | -  | -                        | -               | -  | -  | -                        |
| Ø180 mm Highlite Element   | W                                  | -  | -  | -                        | -               | -  | -  | -                        |
| Ø210 mm Highlite Element   | W                                  | -  | -  | -                        | -               | -  | -  | -                        |
| Ø180 mm Dual Highlite Element  | W                                  | -  | -  | -                        | -               | -  | -  | -                        |
| Ø145 mm Oval Highlite Element  | W                                  | -  | -  | -                        | -               | -  | -  | -                        |
| Ø210 mm Dual Highlite Element  | W                                  | -  | -  | -                        | -               | -  | -  | -                        |
| Ø210 mm Triple Highlite Element  | W                                  | -  | -  | -                        | -               | -  | -  | -                        |
| Ø290 mm Dual/Triple Highlite Element   | W                                  | -  | -  | -                        | -               | -  | -  | -                        |
| Ø 160 mm Induction Zone(Serie 1 and Serie 2)   | W                                  | -  | -  | -                        | -               | -  | -  | -                        |
| Ø 200 mm Induction Zone(Serie 1)   | W                                  | -  | -  | -                        | -               | -  | -  | -                        |
| Ø 210 mm Induction Zone(Serie 2)   | W                                  | -  | -  | -                        | -               | -  | -  | -                        |
| Ø 250 mm Induction Zone(Serie 1)   | W                                  | -  | -  | -                        | -               | -  | -  | -                        |
| Ø 290 mm Induction Zone(Serie 2)   | W                                  | -  | -  | -                        | -               | -  | -  | -                        |
| Boost Funcion  |                                    | -  | -  | -                        | -               | -  | -  | -                        |
| Pot Dedection  |                                    | -  | -  | -                        | -               | -  | -  | -                        |
| Automatic Heatup   |                                    | -  | -  | -                        | -               | -  | -  | -                        |
| Timer function for vitro ceramic hobs (If touch control with some hob configuration selected)    |                                    | -  | -  | -                        | -               | -  | -  | -                        |
| Mode function for induction ceramic hobs (If touch control with some hob configuration selected) |                                    | -  | -  | -                        | -               | -  | -  | -                        |
| Bridge zone for induction ceramic hobs (If touch control with some hob configuration selected)   |                                    | -  | -  | -                        | -               | -  | -  | -                        |
| Child Lock for vitro ceramic hobs (If touch control selected)                                    |                                    | -  | -  | -                        | -               | -  | -  | -                        |
| Mechanical Child Lock (Main Switch)  |                                    | -  | -  | -                        | -               | -  | -  | -                        |
| Hot Surface Indicator Light  |                                    | -  | -  | -                        | -               | -  | -  | -                        |
| Hotplate Operation Indicator Light   |                                    | Standard                                       | Standard                                       | Standard                 | Standard        | Standard                                       | Standard                                       | Standard                 |
| Side Knob Control  |                                    | Standard                                       | Standard                                       | Standard                 | -               | Standard                                       | Standard                                       | Standard                 |
| Side Touch Control   |                                    | -  | -  | -                        | -               | -  | -  | -                        |
| Front Knob Control   |                                    | -  | -  | -                        | Standard        | -  | -  | -                        |
| Double Side Front Control  |                                    | -  | -  | -                        | -               | -  | -  | -                        |
| Front Triangular Touch Control   |                                    | -  | -  | -                        | -               | -  | -  | -                        |
| Front Slider Touch Control   |                                    | -  | -  | -                        | -               | -  | -  | -                        |
| Front Touch Control  |                                    | -  | -  | -                        | -               | -  | -  | -                        |
| Bevelled Edges   |                                    | -  | -  | -                        | -               | -  | -  | -                        |
| Logo   |                                    | Standard                                       | Standard                                       | Standard                 | Standard        | Standard                                       | Standard                                       | Standard                 |
| Special Decoration on Glass  |                                    | -  | -  | -                        | -               | -  | -  | -                        |
| Vitroceramic Glass Artwork   |                                    | -  | -  | -                        | -               | -  | -  | -                        |
| Inox Frame   |                                    | -  | -  | -                        | -               | -  | -  | -                        |
| Stainless Steel Burner Pan   |                                    | -  | -  | -                        | -               | -  | -  | -                        |
| Table Top Installation (not built-in)  |                                    | Standard                                       | Standard                                       | Standard                 | Standard        | Standard                                       | Standard                                       | Standard                 |
| Glass Lid  |                                    | Optional                                       | Optional                                       | Optional                 | -               | Optional                                       | Optional                                       | Optional                 |
| Burner Safety Valves   |                                    | Standard                                       | Standard                                       | Standard                 | Standard        | -  | -  | -                        |
| Button Ignition  |                                    | Optional                                       | Optional                                       | Optional                 | Optional        | -  | -  | -                        |
| One-touch-ignition through knobs   |                                    | Optional                                       | Optional                                       | Optional                 | Optional        | -  | -  | -                        |
| Enamel Pan Supports  |                                    | Standard                                       | Standard                                       | Standard                 | Standard        | -  | -  | -                        |
| Cast Iron Pan Supports   |                                    | Optional                                       | Optional                                       | Optional                 | Optional        | -  | -  | -                        |
| Cast Iron Burner Caps  |                                    | Optional                                       | Optional                                       | Optional                 | Optional        | -  | -  | -                        |
| Coffee Adaptor   |                                    | Optional                                       | Optional                                       | Optional                 | Optional        | -  | -  | -                        |
| Wok Adaptor  |                                    | Optional                                       | Optional                                       | Optional                 | Optional        | -  | -  | -                        |
| Vitroceramic Glass Cleaning Spatula  |                                    | -  | -  | -                        | -               | -  | -  | -                        |
| Gas Conversion Kit   |                                    | Standard                                       | Standard                                       | Standard                 | Standard        | -  | -  | -                        |
| Others   |                                    |  |  |                          |                 |  |  |                          |
| Total Gas Power (Depends on Model) Maximum   | kW                                 | 8,3  | 8,1  | 8,1                      | 8,1             | -  | -  | -                        |
| Total Electric Power (Depends on Model) Maximum  | kW                                 | -  | -  | -                        | 1               | 6  | 6  | 6                        |
| Voltage  | V                                  | 230V~  | 230V~  | 230V~                    | 230V~           | 230 / 400V 3N~                                 | 230 / 400V 3N~                                 | 230 / 400V 3N~           |
| RoHS Compliance  |                                    | Standard                                       | Standard                                       | Standard                 | Standard        | Standard                                       | Standard                                       | Standard                 |
| CE Compliance  |                                    | Standard                                       | Standard                                       | Standard                 | Standard        | Standard                                       | Standard                                       | Standard                 |
| Carton Box Packaging   |                                    | Standard                                       | Standard                                       | Standard                 | Standard        | Standard                                       | Standard                                       | Standard                 |
| Packed Product Dimensions (WxDxH)  | mm                                 | 643 x 645 x 132                                | 643 x 645 x 132                                | x                        | x               | 643 x 645 x 132                                | 643 x 645 x 132                                | x                        |
| Loading Quantity 20 ft (Wrapped Carton)  | pcs                                | 408  | 408  | x                        | x               | 408  | 408  | x                        |
| Loading Quantity 40 ft (Wrapped Carton)  | pcs                                | 918  | 918  | x                        | x               | 918  | 918  | x                        |
| Loading Quantity 40 HC (Wrapped Carton)  | pcs                                | 1026   | 1026   | x                        | x               | 1026   | 1026   | x                        |
| Packed Product Dimensions (WxDxH) Box  | mm                                 | 662 x 648 x 140 (default for glass lid option) | 662 x 648 x 140 (default for glass lid option) | 662 x 648 x 140          | 645 x 648 x 140 | 662 x 648 x 140 (default for glass lid option) | 662 x 648 x 140 (default for glass lid option) | 662 x 648 x 140          |
| Loading Quantity 20 ft (Carton Box)  | pcs                                | 348  | 348  | 348                      | 384             | 384  | 384  | 384                      |
| Loading Quantity 40 ft (Carton Box)  | pcs                                | 864  | 864  | 864                      | 864             | 864  | 864  | 864                      |
| Loading Quantity 40 HC (Carton Box)  | pcs                                | 972  | 972  | 972                      | 972             | 972  | 972  | 972                      |
| Net Weight (Depends on Model) Maximum  | kg                                 | 13   | 13   | 14                       | 15              | 13,5   | 13,5   | 14,5                     |
| Gross Weight (Depends on Model) Maximum  | kg                                 | 14,25  | 14,25  | 15                       | 16              | 14,75  | 14,75  | 15,5                     |

| DOMINO HOB SPECIFICATION SHEET  |     | Domino Gas Hobs | Domino Electric Hobs | Domino Gas Securit Hobs | Domino Vitro Ceramic Hobs | Domino Induction Ceramic Hobs     |
|---|-----|-----------------|----------------------|-------------------------|---------------------------|-----------------------------------|
|   |     | 30 CM           | 30 CM                | 30 CM                   | 30 CM                     | 30 CM                             |
| Available Colours   |     |                 |                      |                         |                           |                                   |
| White   |     | -               | -                    | Optional                | Optional                  | Optional                          |
| Brown   |     | -               | -                    | -                       | -                         | -                                 |
| Terre de France   |     | -               | -                    | -                       | -                         | -                                 |
| Black   |     | -               | -                    | Standard                | Standard                  | Standard                          |
| Dark Green  |     | -               | -                    | -                       | -                         | -                                 |
| Stainless Steel   |     | Standard        | Standard             | -                       | -                         | -                                 |
| Product Dimensions  |     |                 |                      |                         |                           |                                   |
| Height (varies from model to model)   | mm  | 42,5            | 42,5                 | 47,5                    | 47,5                      | 56                                |
| Width   | mm  | 290             | 290                  | 290                     | 290                       | 290                               |
| Depth   | mm  | 510             | 510                  | 520                     | 520                       | 520                               |
| Cut-out Dimensions  |     |                 |                      |                         |                           |                                   |
| Width   | mm  | 270             | 270                  | 270                     | 270                       | 270                               |
| Depth   | mm  | 490             | 490                  | 490                     | 490                       | 490                               |
| Hob Features  |     |                 |                      |                         |                           |                                   |
| Hob   |     | Stainless Steel | Stainless Steel      | Securit                 | Vitro Ceramic             | Induction Ceramic                 |
| Rapid Gas Burner Ø10cm  | W   | 3000            | -                    | 3000                    | -                         | -                                 |
| Semi-rapid Gas Burner Ø7.5cm  | W   | -               | -                    | -                       | -                         | -                                 |
| Auxiliary Gas Burner Ø5.5cm   | W   | 1000            | -                    | 1000                    | -                         | -                                 |
| Wok (Triple Flame) Gas Burner Ø14cm   | W   | 3600            | -                    | 3600                    | -                         | -                                 |
| Ø 145 mm Hotplate   | W   | -               | 1000                 | -                       | -                         | -                                 |
| Ø 180 mm Hotplate   | W   | -               | 1500                 | -                       | -                         | -                                 |
| Ø 145 mm Rapid Hotplate   | W   | -               | -                    | -                       | -                         | -                                 |
| Ø 180 mm Rapid Hotplate   | W   | -               | 2000                 | -                       | -                         | -                                 |
| Ø145 mm Highlite Element  | W   | -               | -                    | -                       | 1200                      | -                                 |
| Ø180 mm Highlite Element  | W   | -               | -                    | -                       | 1800                      | -                                 |
| Ø210 mm Highlite Element  | W   | -               | -                    | -                       | -                         | -                                 |
| Ø180 mm Dual Element  | W   | -               | -                    | -                       | 1700                      | -                                 |
| Ø145 mm Oval Element  | W   | -               | -                    | -                       | -                         | -                                 |
| Ø210 mm Dual Element  | W   | -               | -                    | -                       | -                         | -                                 |
| Ø210 mm Triple Element  | W   | -               | -                    | -                       | -                         | -                                 |
| Ø270 mm Triple Element  | W   | -               | -                    | -                       | -                         | -                                 |
| Rectangular Element   | W   | -               | -                    | -                       | -                         | -                                 |
| Ø 160 mm Induction Zone   | W   | -               | -                    | -                       | -                         | Nominal 1400W<br>max. Boost 1800W |
| Ø 200 mm Induction Zone   | W   | -               | -                    | -                       | -                         | Nominal 2100W<br>max. Boost 2500W |
| Oval Induction Zone   |     |                 |                      |                         |                           | -                                 |
| Boost Function  |     |                 |                      |                         |                           | Standard                          |
| Pot Dedection   |     |                 |                      |                         |                           | Standard                          |
| Automatic Heatup  |     |                 |                      |                         |                           | Standard                          |
| Timer function for vitro ceramic hobs (if touch control with some hob configuration selected) |     |                 |                      |                         |                           | Standard                          |
| Child Lock for vitro ceramic hobs (if touch control selected)                                 |     |                 |                      |                         | Standard                  | Standard                          |
| Hot Surface Indicator Light   |     |                 |                      |                         | Standard                  | Standard                          |
| Hotplate Operation Indicator Light  |     |                 | Standard             |                         |                           |                                   |
| Side Knob Control   |     |                 | Standard             |                         |                           |                                   |
| Side Touch Control  |     |                 |                      |                         |                           |                                   |
| Front Knob Control  |     | Standard        |                      | Standard                | Standard                  |                                   |
| Front Touch Control   |     |                 |                      |                         | Optional                  | Standard                          |
| Front Slim Touch Control  |     |                 |                      |                         |                           |                                   |
| Bevelled Edges  |     |                 |                      |                         | Optional                  | Optional                          |
| Logo  |     | Standard        | Standard             | Optional                | Optional                  | Optional                          |
| Special Decoration on Glass   |     |                 |                      | Optional                | Optional                  | Optional                          |
| Inox Frame  |     |                 |                      | Optional                | Optional                  | Optional                          |
| Stainless Steel Burner Pan  |     |                 |                      | Optional                |                           |                                   |
| Table Top Installation (not built-in)   |     |                 |                      |                         |                           |                                   |
| Glass Lid   |     |                 |                      |                         |                           |                                   |
| Burner Safety Valves  |     | Optional        |                      | Optional                |                           |                                   |
| Button Ignition   |     | Optional        |                      |                         |                           |                                   |
| One-touch-Ignition through knobs  |     | Optional        |                      | Optional                |                           |                                   |
| Enamel Pan Supports   |     | Standard        |                      | Standard                |                           |                                   |
| Cast Iron Pan Supports  |     | Optional        |                      | Optional                |                           |                                   |
| Cast Iron Burner Caps   |     | Optional        |                      | Optional                |                           |                                   |
| Coffee Adaptor  |     | Optional        |                      | Optional                |                           |                                   |
| Wok Adaptor   |     | Optional        |                      | Optional                |                           |                                   |
| Vitroc ceramic Glass Cleaning Spatula   |     |                 |                      |                         | Optional                  | Optional                          |
| Gas Conversion Kit  |     | Standard        |                      | Standard                |                           |                                   |
| Gas Conversion Kit  |     | Standard        |                      | Standard                |                           |                                   |
| Others  |     |                 |                      |                         |                           |                                   |
| Total Power (Depends on Model) Maximum  | kW  | 4               | 3,5                  | 4                       | 3                         | 3,6                               |
| Voltage   | V   | 230 V ~         | 230 V ~              | 230V ~                  | 230 V~                    | 230 V~                            |
| RoHS Compliance   |     | Standard        | Standard             | Standard                | Standard                  | Standard                          |
| CE Compliance   |     | Standard        | Standard             | Standard                | Standard                  | Standard                          |
| Carton Box Packaging  |     | Standard        | Standard             | Standard                | Standard                  | Standard                          |
| Packed Product Dimensions (WxDxH)   | mm  | x               | x                    | 330 x 578 x 140         | 326 x 578 x 133           | 332 x 581 x 142                   |
| Packed Product Dimensions (WxDxH) Box   | mm  | 331 x 566 x 143 | 331 x 566 x 143      | x                       | x                         | x                                 |
| Net Weight (Depends on Model) Maximum   | kg  | 5,5             | 4,75                 | 4,7                     | 4,7                       | 5,5                               |
| Gross Weight (Depends on Model) Maximum   | kg  | 6               | 5,4                  | 5                       | 5                         | 6,2                               |
| Container Loading Quantity (20 ft Container)  | pcs | 1190            | 1190                 | 1088                    | 1088                      | 864                               |
| Container Loading Quantity (40 ft Container)  | pcs | 2499            | 2499                 | 2304                    | 2304                      | 1920                              |
| Container Loading Quantity (40 ft HC Container)   | pcs | 2793            | 2793                 | 2592                    | 2592                      | 2160                              |

OVENS&HOBS // SPECIFICATIONS

































| POLY HOB SPECIFICATION SHEET  |    | Electric Built-in Hob | Vitroceramic Built-in Hob                              | Induction Built-in Hob              |
|---|----|-----------------------|--|-------------------------------------|
|   |    | 60cm                  | 60cm   | 60cm                                |
| Available Colours   |    |                       |  |                                     |
| White   |    | Standard              | Optional   | -                                   |
| Brown   |    | Optional              | -  | -                                   |
| Terre de France   |    | Optional              | -  | -                                   |
| Black   |    | Optional              | Standard   | Standard                            |
| Dark Green  |    | Optional              | -  | -                                   |
| Stainless Steel   |    | Optional              | -  | -                                   |
| Product Dimensions  |    |                       |  |                                     |
| Height  | mm | 39                    | 41   | 53                                  |
| Width   | mm | 580                   | 590  | 590                                 |
| Depth   | mm | 510                   | 520  | 520                                 |
| Cut-out Dimensions  |    |                       |  |                                     |
| Width   | mm | 560                   | 560  | 560                                 |
| Depth   | mm | 490                   | 490  | 490                                 |
| Hob Features  |    |                       |  |                                     |
| Hob   |    | Enamel                | Vitroceramic   | Induction                           |
| Ø 145 mm Hotplate   | W  | 1000                  | -  | -                                   |
| Ø 180 mm Hotplate   | W  | 1500                  | -  | -                                   |
| Ø145 mm Highlite Element  | W  | -                     | 1200   | -                                   |
| Ø180 mm Highlite Element  | W  | -                     | 1800   | -                                   |
| Ø180 mm Dual Element  | W  | -                     | 1700   | -                                   |
| Ø145 mm Oval Element  | W  | -                     | 1800   | -                                   |
| Ø210 mm Highlite Element  | W  | -                     | 2300   | -                                   |
| Ø145 mm Radiant Heating Element   | W  | -                     | 1200   | -                                   |
| Ø180 mm Radiant Heating Element   | W  | -                     | 1700   | -                                   |
| Ø 160 mm Induction Zone   | W  | -                     | -  | Nominal 1400 W max. Boost 1800 W    |
| Ø 200 mm Induction Zone   | W  | -                     | -  | Nominal 2100 W max. Boost 2500 W    |
| Boost Funcion   |    | -                     | -  | Standard                            |
| Pot Dedection   |    | -                     | -  | Standard                            |
| Timer (If touch control and some hob configuration selected for vitroceramic hob) |    | -                     | -  | Standard                            |
| Child Lock (If touch control selected for vitroceramic hob)                       |    | -                     | -  | Standard                            |
| Hot Surface Indicator Light   |    | -                     | Standard   | Standard                            |
| Controls on the built-in oven panel   |    | Standard              | Standard   | Standard                            |
| Controller  |    | 7 step switch         | Energy Regulator/ 7 step switch (with radiant element) | Encoder                             |
| Hotplate Operation Indicator Light  |    | Standard              | -  | -                                   |
| Bevelled Edges  |    | -                     | Optional   | Optional                            |
| Logo  |    | Standard              | Optional   | Optional                            |
| Special Artwork on Glass  |    | -                     | Optional   | Optional                            |
| Standart Vitroceramic Glass Artwork   |    | -                     | Slim Design Arc Design Point Design                    | Slim Design Arc Design Point Design |
| Inox Frame  |    | -                     | Optional   | Optional                            |
| Vitroceramic Glass Cleaning Spatula   |    | -                     | Optional   | Optional                            |
| Others  |    |                       |  |                                     |
| Total Power (Depends on Model) Maximum  | kW | 8,1                   | 9,6  | 10,5                                |
| Voltage   | V  | 230V~                 | 230V~  | 230V~                               |
| RoHS Compliance   |    | Standard              | Standard   | Standard                            |
| CE Compliance   |    | Standard              | Standard   | Standard                            |
| Carton Box Packaging  |    | Standard              | Standard   | Standard                            |
| Packed Product Dimensions (WxDxH)   | mm | 628x580x137           | 618x578x132  | 624x580x142                         |
| Net Weight (Depends on Model) Maximum   | kg | 8,75                  | 7  | 11                                  |
| Gross Weight (Depends on Model) Maximum   | kg | 9,5                   | 8  | 12                                  |

| 65 lt Built-in Oven Energy Class Declarations |  |   |                                      |
|---|--|---|--------------------------------------|
| Model Description                             | Oven Function Designation                      | Available Energy Class Declarations   | Function used for Energy Declaration |
| Static  | (01/02/03/04/13/14/15)                         | B (yellow insulation) A (white insulation)  | Upper + Lower                        |
| Turbo Fan                                     | (05/06/07/08/09/16/17/18/19/23/24/50/51/52/53) | B (yellow insulation) A (yellow/white insulation) A+ (white insulation & Smart LCD Control) | Fan + Ring                           |
| Fan assisted                                  | (10/11/12/20/21/22/25/26)                      | B (yellow insulation) A (yellow/white insulation)   | Upper + Lower + Fan                  |

\*. Owner of this document is Vestel Beyaz Esya A.S.(VBE). VBE has right to make changes on these values without notification by referring this document. - 14.05.2015

| 60 lt Built-in Oven Energy Class Declarations |   |   |                                      |
|---|---|---|--------------------------------------|
| Model Description                             | Oven Function Designation                               | Available Energy Class Declarations                           | Function used for Energy Declaration |
| Static  | (01/02/03/04/13/14/15)                                  | B (with / without cooling fan) A (with / without cooling fan) | Upper + Lower                        |
| Turbo Fan                                     | (05/06/07/08/09/16/17/18/19/23/24/27/28/29/50/51/52/53) | B (with cooling fan) A (with cooling fan)                     | Fan + Ring                           |
| Fan assisted                                  | (10/11/12/20/21/22/25/26)                               | B (with cooling fan) A (with cooling fan)                     | Upper + Lower + Fan                  |

\*. Owner of this document is Vestel Beyaz Esya A.S.(VBE). VBE has right to make changes on these values without notification by referring this document. - 14.05.2015

| Electric Oven Function for Built-in Ovens |                        |   |  |   |                          |                     |   |
|---|------------------------|---|--|---|--------------------------|---------------------|---|
| Function ID                               | Identity in the Market |   | Heating Element, Fan, Turnspit, Grill Availability | Oven Functions  | Electrical Power at 230V | Number of Functions | Limitations   |
| 01  | Static oven            |    | (Top + Bottom)                                     | 0 / TOP+BOTTOM / BOTTOM / TOP   | 2300                     | 3                   | -   |
| 02  | Static oven            |    | (Top + Bottom) + Grill + Turnspit                  | 0 / TOP+BOTTOM / BOTTOM / TOP / GRILL+TURNSPIT  | 2300                     | 4                   | -   |
| 03  | Static oven            |    | (Top + Bottom) + Grill + Turnspit                  | 0 / TOP+BOTTOM / BOTTOM / GRILL+TURNSPIT / DOUBLE GRILL+TURNSPIT  | 2600                     | 4                   | Not available for built-in oven without cooling fan |
| 04  | Static oven            |    | (Top + Bottom) + Grill + Turnspit                  | 0 / OVENLIGHT / TOP+BOTTOM / BOTTOM / TOP / GRILL+TURNSPIT / DOUBLE GRILL+TURNSPIT  | 2600                     | 6                   | Not available for built-in oven without cooling fan |
| 06  | FAN+RING oven          |    | (Fan + Ring) + Grill + Turnspit                    | 0 / DEFROST / FAN+RING / GRILL+TURNSPIT / GRILL+FAN+TURNSPIT  | 2000                     | 4                   | Not available for built-in oven without cooling fan |
| 07  | Multifunction oven     |    | (Top + Bottom + Fan + Ring) + Grill + Turnspit     | 0 / DEFROST / FAN+RING / TOP+BOTTOM / TOP+BOTTOM+FAN / GRILL+TURNSPIT / GRILL+FAN+TURNSPIT  | 2300                     | 6                   | Not available for built-in oven without cooling fan |
| 08  | Multifunction oven     |    | (Top + Bottom + Fan + Ring) + Grill + Turnspit     | 0 / DEFROST / FAN+RING / TOP+BOTTOM / TOP+BOTTOM+FAN / GRILL+TURNSPIT / DOUBLE GRILL+TURNSPIT   | 2600                     | 6                   | Not available for built-in oven without cooling fan |
| 09  | Multifunction oven     |    | (Top + Bottom + Fan + Ring) + Grill + Turnspit     | 0 / OVENLIGHT / DEFROST / FAN+RING / TOP+BOTTOM / TOP+BOTTOM+FAN / PIZZA / GRILL+TURNSPIT / DOUBLE GRILL+TURNSPIT / DOUBLE GRILL+FAN+TURNSPIT                 | 3100                     | 9                   | Not available for built-in oven without cooling fan |
| 10  | Fan assisted oven      |    | (Top + Bottom + Fan) + Grill + Turnspit            | 0 / DEFROST / TOP+BOTTOM / TOP+BOTTOM+FAN / GRILL+TURNSPIT / GRILL+FAN+TURNSPIT   | 2300                     | 5                   | Not available for built-in oven without cooling fan |
| 11  | Fan assisted oven      |    | (Top + Bottom + Fan) + Grill + Turnspit            | 0 / DEFROST / TOP+BOTTOM / TOP+BOTTOM+FAN / GRILL+TURNSPIT / DOUBLE GRILL+TURNSPIT  | 2600                     | 5                   | Not available for built-in oven without cooling fan |
| 12  | Fan assisted oven      |    | (Top + Bottom + Fan) + Grill + Turnspit            | 0 / OVENLIGHT / DEFROST / TOP+BOTTOM / TOP+BOTTOM+FAN / BOTTOM+FAN / GRILL+TURNSPIT / DOUBLE GRILL+TURNSPIT / DOUBLE GRILL+FAN+TURNSPIT                       | 2600                     | 8                   | Not available for built-in oven without cooling fan |
| 13  | Static oven            |    | (Top + Bottom) + Grill                             | 0 / TOP+BOTTOM / BOTTOM / TOP / GRILL   | 2300                     | 4                   | -   |
| 14  | Static oven            |  | (Top + Bottom) + Grill                             | 0 / TOP+BOTTOM / BOTTOM / GRILL / DOUBLE GRILL  | 2600                     | 4                   | Not available for built-in oven without cooling fan |
| 15  | Static oven            |  | (Top + Bottom) + Grill                             | 0 / OVENLIGHT / TOP+BOTTOM / BOTTOM / TOP / GRILL / DOUBLE GRILL  | 2600                     | 6                   | Not available for built-in oven without cooling fan |
| 16  | FAN+RING oven          |  | (Fan + Ring) + Grill                               | 0 / DEFROST / FAN+RING / GRILL / GRILL+FAN  | 2000                     | 4                   | Not available for built-in oven without cooling fan |
| 17  | Multifunction oven     |  | (Top + Bottom + Fan + Ring) + Grill                | 0 / DEFROST / FAN+RING / TOP+BOTTOM / TOP+BOTTOM+FAN / GRILL / GRILL+FAN  | 2300                     | 6                   | Not available for built-in oven without cooling fan |
| 18  | Multifunction oven     |  | (Top + Bottom + Fan + Ring) + Grill                | 0 / DEFROST / FAN+RING / TOP+BOTTOM / TOP+BOTTOM+FAN / GRILL / DOUBLE GRILL   | 2600                     | 6                   | Not available for built-in oven without cooling fan |
| 19  | Multifunction oven     |  | (Top + Bottom + Fan + Ring) + Grill                | 0 / OVENLIGHT / DEFROST / FAN+RING / TOP+BOTTOM / TOP+BOTTOM+FAN / PIZZA / GRILL / DOUBLE GRILL / DOUBLE GRILL+FAN  | 3100                     | 9                   | Not available for built-in oven without cooling fan |
| 20  | Fan assisted oven      |  | (Top + Bottom + Fan) + Grill                       | 0 / DEFROST / TOP+BOTTOM / TOP+BOTTOM+FAN / GRILL / GRILL+FAN   | 2300                     | 5                   | Not available for built-in oven without cooling fan |
| 21  | Fan assisted oven      |  | (Top + Bottom + Fan) + Grill                       | 0 / DEFROST / TOP+BOTTOM / TOP+BOTTOM+FAN / GRILL / DOUBLE GRILL  | 2600                     | 5                   | Not available for built-in oven without cooling fan |
| 22  | Fan assisted oven      |  | (Top + Bottom + Fan) + Grill                       | 0 / OVENLIGHT / DEFROST / TOP+BOTTOM / TOP+BOTTOM+FAN / BOTTOM+FAN / GRILL / DOUBLE GRILL / DOUBLE GRILL+FAN  | 2600                     | 8                   | Not available for built-in oven without cooling fan |
| 23  | Multifunction oven     |  | (Top + Bottom + Fan + Ring)                        | 0 / DEFROST / FAN+RING / TOP+BOTTOM / TOP+BOTTOM+FAN  | 2300                     | 4                   | Not available for built-in oven without cooling fan |
| 24  | Multifunction oven     |  | (Top + Bottom + Fan + Ring) + Turnspit             | 0 / DEFROST / FAN+RING+TURNSPIT / TOP+BOTTOM+TURNSPIT / TOP+BOTTOM+FAN+TURNSPIT   | 2300                     | 4                   | Not available for built-in oven without cooling fan |
| 25  | Fan assisted oven      |  | (Top + Bottom + Fan)                               | 0 / DEFROST / TOP+BOTTOM / TOP+BOTTOM+FAN   | 2300                     | 3                   | Not available for built-in oven without cooling fan |
| 26  | Fan assisted oven      |  | (Top + Bottom + Fan) + Turnspit                    | 0 / DEFROST / TOP+BOTTOM+TURNSPIT / TOP+BOTTOM+FAN+TURNSPIT   | 2300                     | 3                   | Not available for built-in oven without cooling fan |
| 27  | Fan assisted oven      |  | (Top + Bottom + Fan) + Grill                       | 0 / DEFROST / TOP+BOTTOM / TOP+BOTTOM+FAN / GRILL / DOUBLE GRILL / PYROLYSIS  | 2600                     | 6                   | Available for only pyrolytic oven                   |
| 28  | Multifunction oven     |  | (Top + Bottom + Fan + Ring) + Grill                | 0 / DEFROST / FAN+RING / TOP+BOTTOM / TOP+BOTTOM+FAN / GRILL / DOUBLE GRILL / DOUBLE GRILL + FAN / PYROLYSIS  | 2600                     | 8                   | Available for only pyrolytic oven                   |
| 29  | Multifunction oven     |  | (Top + Bottom + Fan + Ring) + Grill + Turnspit     | 0 / DEFROST / FAN+RING / TOP+BOTTOM / TOP+BOTTOM+FAN / GRILL+TURNSPIT / DOUBLE GRILL+TURNSPIT / DOUBLE GRILL+FAN+TURNSPIT / PYROLYSIS                         | 2600                     | 8                   | Available for only pyrolytic oven                   |
| 50  | Multifunction oven     |  | (Top + Bottom + Fan + Ring) + Grill + Turnspit     | 0 / OVENLIGHT / DEFROST / FAN+RING / TOP+BOTTOM / TOP+BOTTOM+FAN / PIZZA / GRILL + TURNSPIT / DOUBLE GRILL+TURNSPIT / DOUBLE GRILL+FAN + TURNSPIT / VAP CLEAN | 3100                     | 10                  | Not available for built-in oven without cooling fan |
| 51  | Multifunction oven     |  | (Top + Bottom + Fan + Ring) + Grill                | 0 / OVENLIGHT / DEFROST / FAN+RING / TOP+BOTTOM / TOP+BOTTOM+FAN / PIZZA / GRILL / DOUBLE GRILL / DOUBLE GRILL+FAN / VAP CLEAN                                | 2300                     | 10                  | Not available for built-in oven without cooling fan |
| 52  | Fan assisted oven      |  | (Top + Bottom + Fan) + Grill                       | 0 / DEFROST / BOTTOM / TOP+BOTTOM / TOP+BOTTOM+FAN / GRILL / GRILL+FAN  | 2300                     | 6                   | Not available for built-in oven without cooling fan |
| 53  | Fan assisted oven      |  | (Top + Bottom + Fan)                               | 0 / BOTTOM / TOP / TOP+BOTTOM / TOP+BOTTOM+FAN  | 2300                     | 4                   | Not available for built-in oven without cooling fan |



| Induction Hob Configurations for Built-in Hobs and Polyvalente Hobs |  |                                  |                   |               |                            |
|---|--|----------------------------------|-------------------|---------------|----------------------------|
| HOB ID  | CONFIGURATION  | LIMITATIONS                      | ELEMENT PLACEMENT | GENERATION    | CONTROL SYSTEM             |
| 18  | 2 x 160mm, 1400/1800W induction element<br>2 x 200mm, 2100/2500W induction element   | Available for both 60cm and 78cm |                   | VESTEL SERI 1 | STANDARD                   |
| 19  | 2 x 160mm, 1400/1800W induction element<br>2 x 200mm, 2100/2500W induction element with timer  | Available for both 60cm and 78cm |                   | VESTEL SERI 1 | STANDARD OR SLIDER CONTROL |
| 20  | 2 x 160mm, 1400/1800W induction element<br>2 x 200mm, 2100/2500W induction element with timer  | Available only for POLYVALENTE   |                   | VESTEL SERI 1 | KNOB CONTROL               |
| 20  | 1 x 160mm, 1400/1800W induction element<br>2 x 200mm, 2100/2500W induction element   | Available only for 60cm          |                   | VESTEL SERI 1 | STANDARD                   |
| 21  | 1 x 160mm, 1400/1800W induction element<br>2 x 200mm, 2100/2500W induction element with timer  | Available only for 60cm          |                   | VESTEL SERI 1 | STANDARD OR SLIDER CONTROL |
| 22  | 1 x 160mm, 1400/1800W induction element<br>1 x 200mm, 2100/2500W induction element<br>1 x 250mm, 2800/3500W induction element            | Available only for 60cm          |                   | VESTEL SERI 1 | STANDARD                   |
| 23  | 1 x 160mm, 1400/1800W induction element<br>1 x 200mm, 2100/2500W induction element<br>1 x 250mm, 2800/3500W induction element with timer | Available only for 60cm          |                   | VESTEL SERI 1 | STANDARD OR SLIDER CONTROL |
| 24  | 2 x 160mm, 1400/1800W induction element<br>1 x 200mm, 2100/2500W induction element   | Available only for 30cm          |                   | VESTEL SERI 1 | STANDARD                   |
| 25  | 3 x 160mm, 1400/1800W induction element<br>1 x 200mm, 2100/2500W induction element with timer  | Available only for 30cm          |                   | VESTEL SERI 1 | STANDARD                   |
| 26  | 2 x 160mm, 1400/1800W induction element<br>2 x 200mm, 2100/2500W induction element<br>1 x 250mm, 2800/3500W induction element with timer | Available only for 90cm          |                   | VESTEL SERI 1 | STANDARD                   |
| 27  | 3 x 160mm, 1400/1800W induction element<br>1 x 200mm, 2100/2500W induction element<br>bridge zone, mode function, timer                  | Available only for 60cm          |                   | VESTEL SERI 1 | STANDARD                   |
| 28  | 1 x 160mm, 1400/1800W induction element<br>2 x 210mm, 2100/2500W induction element   | Available only for 60cm          |                   | VESTEL SERI 2 | STANDARD                   |
| 29  | 1 x 160mm, 1400/1800W induction element<br>2 x 210mm, 2100/2500W induction element with timer  | Available only for 60cm          |                   | VESTEL SERI 2 | STANDARD OR SLIDER CONTROL |
| 30  | 1 x 160mm, 1400/1800W induction element<br>1 x 210mm, 2100/2500W induction element<br>1 x 290mm, 2800/3500W induction element            | Available only for 60cm          |                   | VESTEL SERI 2 | STANDARD                   |
| 31  | 1 x 160mm, 1400/1800W induction element<br>1 x 210mm, 2100/2500W induction element<br>1 x 290mm, 2800/3500W induction element with timer | Available only for 60cm          |                   | VESTEL SERI 2 | STANDARD OR SLIDER CONTROL |
| 32  | 2 x 160mm, 1400/1800W induction element<br>2 x 210mm, 2100/2500W induction element   | Available only for 60cm          |                   | VESTEL SERI 2 | STANDARD                   |
| 33  | 2 x 160mm, 1400/1800W induction element<br>2 x 210mm, 2100/2500W induction element with timer  | Available only for 60cm          |                   | VESTEL SERI 2 | STANDARD OR SLIDER CONTROL |

| 78cm Vitroc ceramic Hob Configurations |   |                   |                            |
|--|---|-------------------|----------------------------|
| HOB ID                                 | Highlight Element Configuration   | ELEMENT PLACEMENT | CONTROL SYSTEM             |
| 1                                      | 2 x 145 Highlite, 1 x oval, 1 x 180 highlite element                      |                   | STANDART                   |
| *2                                     | 2 x 145 Highlite, 1 x oval, 1 x 180 highlite element with timer           |                   |                            |
| 3                                      | 2 x 145 Highlite, 1 x dual, 1 x 210 highlite element                      |                   | STANDART                   |
| *4                                     | 2 x 145 Highlite, 1 x dual, 1 x 210 highlite element with timer           |                   |                            |
| *5                                     | 2 x 145 Highlite, 1 x 210, 1 x oval highlite element                      |                   |                            |
| *6                                     | 2 x 145 Highlite, 1 x 210, 1 x oval highlite element with timer           |                   |                            |
| 9                                      | 1 x 145 Highlite, 1 x 180, 1 x dual, 1 x oval highlite element            |                   | STANDART                   |
| 10                                     | 1 x 145 Highlite, 1 x 180, 1 x dual, 1 x oval highlite element with timer |                   | STANDART OR SLIDER CONTROL |
| *11                                    | 2 x 145 Highlite, 1 x dual, 1 x oval highlite element                     |                   |                            |
| *12                                    | 2 x 145 Highlite, 1 x dual, 1 x oval highlite element with timer          |                   |                            |
| *13                                    | 2 x 145 Highlite, 1 x 210 dual, 1 x oval highlite element                 |                   |                            |
| *14                                    | 2 x 145 Highlite, 1 x 210 dual, 1 x oval highlite element with timer      |                   |                            |
| *17                                    | 2 x 145 Highlite, 1 x triple, 1 x dual highlite element                   |                   |                            |
| *18                                    | 2 x 145 Highlite, 1 x triple, 1 x dual highlite element with timer        |                   |                            |
| *19                                    | 2 x 145 Highlite, 1 x oval, 1 x triple highlite element                   |                   |                            |
| *20                                    | 2 x 145 Highlite, 1 x oval, 1 x triple highlite element with timer        |                   |                            |

\*: Available upon request with warranty of a certain amount.

| 60cm Vitroceramic Hob with Front Triangular Touch Control (FRTR) |  |                   |                            |
|--|--|-------------------|----------------------------|
| HOB ID   | CONFIGURATION  | ELEMENT PLACEMENT | CONTROL SYSTEM             |
| 1  | 2 x 145, 2 x 180 highlight element                               |                   | STANDART OR SLIDER CONTROL |
| 2  | 2 x 145, 1 x 180, 1 x 180 dual highlight element                 |                   | STANDART                   |
| 3  | 2 x 145, 1 x 180, 1 x 210 highlight element                      |                   | STANDART OR SLIDER CONTROL |
| 4  | 2 x 145, 1 x 210, 1 x 180 dual highlight element                 |                   | STANDART                   |
| 5  | 2x145,1x180,1xoval highlight                                     |                   | STANDART                   |
| 6  | 2 x 145, 1 x 180 dual, 1 x oval highlight element                |                   | STANDART                   |
| 7*   | 2 x 145, 1 x 210, 1 oval highlight element                       |                   | STANDART                   |
| 8  | 2 x 145, 1 x 180, 1 x 180 dual highlight element with timer      |                   | STANDART                   |
| 9  | 2 x 145, 1 x 180 dual, 1 x oval highlight element with timer     |                   | STANDART                   |
| 10   | 2 x 145, 1 x 180, 1 x 210 triple highlight element with timer    |                   | STANDART OR SLIDER CONTROL |
| 11   | 2 x 145, 1 x 180 dual, 1 x 210 triple highlight element          |                   | STANDART                   |
| 12   | 2 x 145, 1 x oval, 1 x 210 triple highlight element              |                   | STANDART                   |
| 13   | 1 x 145, 1 x 180, 1 x 290 triple highlight element               |                   | STANDART                   |
| 14*  | 2 x 145, 1 x 210 dual, 1 x 180 dual highlight element            |                   | STANDART                   |
| 15*  | 2 x 145, 1 x 210 dual, 1 x 180 dual highlight element with timer |                   | STANDART                   |
| 22*  | 1x145, 1x180, 1x210 highlight element                            |                   | STANDART                   |
| 23*  | 1x145, 1x180, 1x210 dual highlight element                       |                   | STANDART                   |
| 24*  | 1x145, 2x180 highlight element                                   |                   | STANDART                   |
| 25   | 1 x 145, 1 x 180, 1 x 290 dual highlight element                 |                   | STANDART                   |
| 26   | 1 x 145, 1 x 180, 1 x 290 dual highlight element with timer      |                   | STANDART OR SLIDER CONTROL |
| 27   | 2 x 145, 2 x 180 highlight element, timer                        |                   | STANDART                   |
| 35   | 1 x 145, 1 x 180, 1x290 highlight element, timer                 |                   | SLIDER CONTROL             |

\*Available upon request

| 60cm Vitroceramic Hob with Side Touch Control (SDTC) |  |                   |                |
|--|--|-------------------|----------------|
| HOB ID   | CONFIGURATION  | ELEMENT PLACEMENT | CONTROL SYSTEM |
| 1  | 2 x 145, 2 x 180 highlight element                               |                   | STANDART       |
| 2  | 2 x 145, 1 x 180, 1 x 180 dual highlight element                 |                   | STANDART       |
| 3  | 2 x 145, 1 x 180, 1 x 210 highlight element                      |                   | STANDART       |
| 4  | 2 x 145, 1 x 210, 1 x 180 dual highlight element                 |                   | STANDART       |
| 5*   | 2 x 145, 1 x 180, 1 x oval highlight element                     |                   | STANDART       |
| 6*   | 2 x 145, 1 x 180 dual, 1 x oval highlight element                |                   | STANDART       |
| 7*   | 2 x 145, 1 x 210, 1 oval highlight element                       |                   | STANDART       |
| 9*   | 2 x 145, 1 x 180 dual, 1 x 180 dual highlight element with timer |                   | STANDART       |
| 10*  | 2 x 145, 1 x 180, 1 x 210 triple highlight element               |                   | STANDART       |
| 14*  | 2 x 145, 1 x 210 dual, 1 x 180 dual highlight element            |                   | STANDART       |
| 15*  | 2 x 145, 1 x 210 dual, 1 x 180 dual highlight element with timer |                   | STANDART       |

\*Available upon request

| 60cm Vitroceramic Hob with Side Knob Control (SDKB) |   |                   |             |
|---|---|-------------------|-------------|
| HOB ID  | CONFIGURATION                                     | ELEMENT PLACEMENT | LIMITATIONS |
| 1   | 2 x 145, 2 x 180 highlight element                |                   | None        |
| 2   | 2 x 145, 1 x 180, 1 x 180 dual highlight element  |                   | None        |
| 3   | 2 x 145, 1 x 180, 1 x 210 highlight element       |                   | None        |
| 4   | 2 x 145, 1 x 210, 1 x 180 dual highlight element  |                   | None        |
| 5*  | 2 x 145, 1 x 180, 1 x oval highlight element      |                   | None        |
| 6*  | 2 x 145, 1 x 180 dual, 1 x oval highlight element |                   | None        |
| 7   | 2 x 145, 1 x 210, 1 oval highlight element        |                   | None        |

\*Available upon request

| 60cm Vitroceramic Hob for Combi Built-in Oven (POLY) |   |                   |                |
|--|---|-------------------|----------------|
| HOB ID   | CONFIGURATION   | ELEMENT PLACEMENT | CONTROL SYSTEM |
| 4  | 2 x 145, 2 x 180 highlight element                      |                   | None           |
| 5*   | 2 x 145, 1 x 180, 1 x 180 dual highlight element        |                   | None           |
| 6*   | 2 x 145, 1 x 180, 1 x 210 triple highlight element      |                   | None           |
| 7*   | 2 x 145, 1 x 180 dual, 1 x 210 triple highlight element |                   | None           |
| 8*   | 2 x 145, 1 x oval, 1 x 210 triple highlight element     |                   | None           |
| 9  | 2 x 145, 1 x 180 dual, 1 x oval highlight element       |                   | None           |
| 10*  | 2 x 145, 1 x 180, 1 x oval highlight element            |                   | None           |
| 11   | 2 x 145, 1 x 180, 1 x 210 highlight element             |                   | None           |
| 12*  | 2 x 145, 1 x 210, 1 x 180 dual highlight element        |                   | None           |
| 13*  | 2 x 145, 1 x 210, 1 oval highlight element              |                   | None           |
| 14*  | 2 x 145, 1 x oval, 1 x 210 dual highlight element       |                   | None           |

\*Available upon request

| 60cm Side Controlled Solid Hotplate and Polyvalente Built-in Electric Hob Configurations |   |   |                   |
|--|---|---|-------------------|
| HOB ID   | CONFIGURATION   | LIMITATIONS                                     | ELEMENT PLACEMENT |
| 01   | 2 x 145, 2 x 180 hotplate                               | None  |                   |
| 02   | 2 x 145, 1 x 180, 1 x 180 rapid hotplate                | None  |                   |
| 03   | 1 x 145, 1 x 145 rapid, 1 x 180, 1 x 180 rapid hotplate | Not available for polyvalente type hob          |                   |
| *04  | 1 x 145, 1 x 145 rapid, 2 x 180 hotplate                | Not available for polyvalente type electric hob |                   |

60CM SIDE CONTROLLED SOLID HOTPLATE HOBS ARE AVAILABLE FOR TABLE TOP  
 \*: Available upon request with warranty of a certain amount.

| 60cm Side Controlled Gas Hob Configurations |   |                                    |                   |
|---|---|------------------------------------|-------------------|
| HOB ID                                      | CONFIGURATION   | LIMITATIONS                        | ELEMENT PLACEMENT |
| 31  | 1 x Auxiliary, 1 x Semi Rapid, 1 x Rapid Burner, 1 x Hotplate | Not available for gas on glass hob |                   |
| 40  | 1 x Auxiliary, 2 x Semi Rapid, 1 x Rapid Burner               | None                               |                   |
| 41  | 1 x Auxiliary, 2 x Semi Rapid, 1 x Triple Flame Burner        | None                               |                   |

60CM SIDE CONTROLLED GAS HOBS ARE AVAILABLE FOR TABLE TOP APPLICATION

| 60cm Front Controlled Gas Hob Configurations |   |  |                   |
|--|---|--|-------------------|
| HOB ID                                       | CONFIGURATION   | LIMITATIONS                                | ELEMENT PLACEMENT |
| 31   | 1 x Auxiliary, 1 x Semi Rapid, 1 x Rapid Burner, 1 x Hotplate | Model I not available for gas on glass hob |                   |
| 40   | 1 x Auxiliary, 2 x Semi Rapid, 1 x Rapid Burner               | None                                       |                   |
| 41   | 1 x Auxiliary, 2 x Semi Rapid, 1 x Triple Flame Burner        | None                                       |                   |

| 30cm Gas On Glass Hob Configurations |                                 |                   |
|--------------------------------------|---------------------------------|-------------------|
| HOB ID                               | CONFIGURATION                   | ELEMENT PLACEMENT |
| 10                                   | 1 x Triple Flame Burner         |                   |
| 20                                   | 1 x Auxiliary, 1 x Rapid Burner |                   |

| 60cm Pure Design Combined Hobs Configurations |  |  |                   |
|---|--|--|-------------------|
| HOB ID  | CONFIGURATION  | LIMITATIONS  | ELEMENT PLACEMENT |
| 62  | 2 Gas Heaters (1 x Rapid & 1 x Semi Rapid)<br>2 HiLight Heaters (1X180 & 1X145)  | Available for only side knob control   |                   |
| 64  | 2 Gas Heaters (1 x Rapid & 1 x Auxiliary)<br>2 HiLight Heaters (1X180 & 1X145)   | Available for only side knob control   |                   |
| 66  | 3 Gas Heaters (1 x Semi Rapid & 1 x Auxiliary & 1 x Rapid)<br>1 HiLight Heater (1X180)   | Available for only side knob control   |                   |
| 67  | 3 Gas Heaters (1 x Semi Rapid & 1 x Auxiliary & 1 x Rapid)<br>1 HiLight Heater (1X180 DUAL)  | Available for only side knob control   |                   |
| 69  | 2 Gas Heaters (1 x Rapid & 1 x Semi Rapid)<br>2 Induction Heaters with timer<br>1X200 (Nominal 2100W max.Boost 2500W)<br>1X160 (Nominal 1400W max.Boost 1800W) | Available for only side control.<br>Touch control is standard for induction heaters, knob control is standard for gas heaters. |                   |

| 90cm Front Controlled Gas Hob Configurations |  |             |                   |
|--|--|-------------|-------------------|
| HOB ID                                       | CONFIGURATION  | LIMITATIONS | ELEMENT PLACEMENT |
| 51   | 1 x Auxiliary, 2 x Semi Rapid, 1 x Rapid, 1 x Triple Flame Burner (MONO) | None        |                   |
| 53   | 2 x Auxiliary, 2 x Semi Rapid, 1 x Rapid, 1 x Triple Flame Burner (DUAL) | None        |                   |

| 70cm Front Controlled Gas Hob Configurations |   |                          |                   |
|--|---|--------------------------|-------------------|
| HOB ID                                       | CONFIGURATION   | LIMITATIONS              | ELEMENT PLACEMENT |
| 50   | 1 x Auxiliary, 2 x Semi Rapid, 2 x Rapid Burner                   | Not available for Plus x |                   |
| 51   | 1 x Auxiliary, 2 x Semi Rapid, 1 x Rapid, 1 x Triple Flame Burner | None                     |                   |

| 30cm Induction Hob Configurations |   |                   |
|-----------------------------------|---|-------------------|
| HOB ID                            | CONFIGURATION   | ELEMENT PLACEMENT |
| 24                                | 1 x 160 mm, 1400 / B1800W induction element<br>1 x 200 mm, 2100 / B2500W induction element            |                   |
| 25                                | 1 x 160 mm, 1400 / B1800W induction element<br>1 x 200 mm, 2100 / B2500W induction element with timer |                   |

| 30cm Solid Hotplate Hob Configurations |  |                   |             |
|--|--|-------------------|-------------|
| HOB ID                                 | CONFIGURATION                              | ELEMENT PLACEMENT | LIMITATIONS |
| 05                                     | 1 x 145, 1 x 180 hotplate                  |                   | None        |
| *06                                    | 1x145 rapid hotplate, 1x180 rapid hotplate |                   |             |
| *07                                    | 1x145rapid hotplate, 1x180 hotplate        |                   |             |
| 08                                     | 1x145 hotplate, 1x180 rapid hotplate       |                   | None        |











| 30cm Vitroceramic Hob Configurations |   |                   |
|--------------------------------------|---|-------------------|
| HOB ID                               | CONFIGURATION   | ELEMENT PLACEMENT |
| 16                                   | 1 x 180 Highlight, 1 x 145 Highlight element            |                   |
| 17                                   | 1 x 180 Dual, 1 x 145 Highlight element                 |                   |
| 19                                   | 1 x 180 Highlight, 1 x 145 Highlight element with timer |                   |
| 20                                   | 1 x 180 Dual, 1 x 145 Highlight element with timer      |                   |



































\*: Available upon request with warranty of a certain amount.













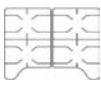

ALL ELEMENT CONFIGURATIONS ARE APPLICABLE FOR BOTH KNOB CONTROL AND TOUCH CONTROL UNIT















|        | Built-in Oven Add_on Limitations Table (60lt or 65lt) |                     |                       |                     |                    |                       |                    |                     |
|--------|---|---------------------|-----------------------|---------------------|--------------------|-----------------------|--------------------|---------------------|
|        | I Type Add_on   |                     | U Type Add_on         |                     | O Type Add_on      |                       | Mono Stripe Add_on | O Type              |
|        | Inox Control Panel                                    | Glass Control Panel | Inox Control Panel    | Glass Control Panel | Inox Control Panel | Glass Control Panel   | Inox Control Panel | Glass Control Panel |
| 17 mm  |   |                     |                       |                     |                    |                       |                    |                     |
|        | Laser Cut   | Laser Cut           | Laser Cut             | Laser Cut           | N/A                | N/A                   | Laser Cut          | Laser Cut           |
| 50 mm  |   |                     |                       |                     |                    |                       |                    |                     |
|        | Cladding  | Cladding            | Cladding or Laser Cut | Cladding            | Cladding           | Cladding or Laser Cut | Laser Cut          | Laser Cut           |
| 65 mm  |   |                     |                       |                     |                    |                       |                    |                     |
|        | Cladding  | Cladding            | Cladding              | Cladding            | N/A                | N/A                   | N/A                | N/A                 |
| 80 mm  |   |                     |                       |                     |                    |                       |                    |                     |
|        | N/A   | N/A                 | N/A                   | N/A                 | N/A                | N/A                   | Laser Cut          | Laser Cut           |
| 85 mm  |   |                     |                       |                     |                    |                       |                    |                     |
|        | N/A   | N/A                 | N/A                   | N/A                 | Cladding           | Cladding              | N/A                | N/A                 |
| 100 mm |   |                     |                       |                     |                    |                       |                    |                     |
|        | N/A   | N/A                 | N/A                   | N/A                 | N/A                | N/A                   | Laser cut          | Laser cut           |

| Duo Stripe Add_on<br>Glass Control Panel | Trio Stripe Add_on<br>Glass Control Panel | Corner Add_on<br>Glass Control Panel | Visio Touch Add_on<br>Glass Control Panel | Visio Display Add_on<br>Glass Control Panel | Smart LCD Add_on<br>Glass Control Panel |
|--|---|--------------------------------------|---|---|---|
|  |   |                                      |   |   |   |
| Laser Cut                                | Laser Cut                                 | Laser Cut                            | Laser Cut                                 | Laser Cut                                   | Laser Cut                               |













| Built-in Oven Add_on Limitations Table (75lt) |   |   |   |   |   |  |   |   |   |
|---|---|---|---|---|---|--|---|---|---|
|   | I Type Add_on   |   | U Type Add_on   |   | O Type Add_on O Type  |  | Mono Stripe Add_on O Type   |   | Duo Stripe Add_on   |
|   | Inox Control Panel  | Glass Control Panel   | Inox Control Panel  | Glass Control Panel   | Inox Control Panel  | Glass Control Panel  | Inox Control Panel  | Glass Control Panel   | Inox Control Panel  |
| 17 mm   | N/A   | N/A   |  |  | N/A   | N/A  | N/A   | N/A   | N/A   |
|   |   |   | Laser Cut   | Laser Cut   |   |  |   |   |   |
| 40 mm   |  |  |  |  |  |  | N/A   | N/A   | N/A   |
|   | Cladding  | Cladding  | Cladding  | Cladding  | Cladding  | Cladding   |   |   |   |
| 50 mm   | N/A   | N/A   | N/A   | N/A   | N/A   | N/A  |  |  |  |
|   |   |   |   |   |   |  | Laser Cut   | Laser Cut   | Laser Cut   |

|                  |   | ENAMELLED PAN SUPPORTS  |   |   |   |   | CAST IRON PAN SUPPORTS   |                  |                  |   |
|------------------|---|---|---|---|---|---|--|------------------|------------------|---|
|                  |   | S-type  | V-type  | O-type  | K-type  | D-type  | S-type Cast Iron   | W-type Cast Iron | K-type Cast Iron | Extenda Cast Iron   |
|                  |   | 0°  | 0°  | 45°   | 45°   | 0°  | 0°   | 45°              | 45°              | 0°  |
| FLAT (R, S type) |  |  |  |  |  |  |  | N/A              | N/A              | N/A   |
| FLAT (T type)    |  |  |  |  |  |  |  | N/A              | N/A              |  |
| SURFACE          |  |  |  |  |  |  |  | N/A              | N/A              | N/A   |
| SMOOTHLINE       |  |  |  | N/A   | N/A   |  | N/A  | N/A              | N/A              |   |
| NEW FREESTANDING |  |  |  |  |  |  |  | N/A              | N/A              | N/A   |
| DIVISION         |  | N/A   | N/A   | N/A   | N/A   | N/A   |  | N/A              | N/A              | N/A   |



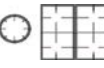



|                       |              | ENAMELLED PAN SUPPORTS  |   |        |        |   | CAST IRON PAN SUPPORTS |   |                  |   |     |
|-----------------------|--------------|---|---|--------|--------|---|------------------------|---|------------------|---|-----|
|                       |              | S-type  | V-type  | O-type | K-type | D-type  | S-type Cast Iron       | W-type Cast Iron  | K-type Cast Iron | Extenda Cast Iron   |     |
|                       |              | 0°  | 0°  | 45°    | 45°    | 0°  | 0°                     | 45°   | 45°              | 0°  |     |
| FRONT CONTROLLED HOBS | 30 cm Domino |  |  | N/A    | N/A    | N/A   | N/A                    |  | N/A              | N/A   | N/A |
|                       | 60 cm Model1 |  |  | N/A    | N/A    |  | N/A                    | N/A   | N/A              |  | N/A |
|                       | 70 cm Model1 |  |  | N/A    | N/A    | N/A   | N/A                    | N/A   | N/A              |  | N/A |
|                       | 60 cm Plusx  |  |  | N/A    | N/A    | N/A   | N/A                    |  | N/A              | N/A   | N/A |
|                       | 70 cm Plusx  |  |  | N/A    | N/A    | N/A   | N/A                    |  | N/A              | N/A   | N/A |

|                                  |                          | ENAMELLED PAN SUPPORTS  |   |   |   |  | CAST IRON PAN SUPPORTS  |   |   |     |
|----------------------------------|--------------------------|---|---|---|---|--|---|---|---|-----|
|                                  |                          | Mono, Standard  | Mono, Plusx   | Mono, Profile   | Mono Cast Iron  | Mono Cast, Plusx   | Line Cast Iron  | Deluxe Cast Iron  | S-type Cast Iron  |     |
|                                  |                          |  |  |  |  |  |  |  |  |     |
|                                  |                          | 45°   | 45°   | 45°   | 45°   | 45°  | 0°  | 45°   | 0°  |     |
| SIDE CONTROLLED GAS SECURIT HOBS | SECURIT II 4G            |  | ✓   | ✓   | ✓   | ✓  | ✓   | N/A   | N/A   | N/A |
|                                  | SECURIT II               |  | ✓   | ✓   | ✓   | ✓  | N/A   | N/A   | N/A   | N/A |
|                                  | SECURIT II TRIO          |  | ✓   | ✓   | ✓   | N/A  | ✓   | N/A   | N/A   | N/A |
|                                  | PURE DESIGN 2GAS+2 VITRO |  | ✓   | ✓   | ✓   | ✓  | ✓   | N/A   | N/A   | N/A |
|                                  | PURE DESIGN 3GAS+1 VITRO |  | ✓   | ✓   | ✓   | ✓  | ✓   | N/A   | N/A   | N/A |
|                                  | PURE DESIGN 2GAS+2 IND   |  | ✓   | ✓   | ✓   | ✓  | ✓   | N/A   | N/A   | N/A |
|                                  | DIVISION                 |  | N/A   | N/A   | N/A   | N/A  | N/A   | N/A   | N/A   | ✓   |



|                                   |  | ENAMELLED PAN SUPPORTS  |   |   |   |   | CAST IRON PAN SUPPORTS   |   |   |   |  |
|-----------------------------------|--|---|---|---|---|---|--|---|---|---|--|
|                                   |  | Lama Mono, Standart   | Plusx Mono, Plusx   | Mono, Profile   | Mono Cast Iron  | Mono Cast, Plusx  | Line Cast Iron   | Deluxe Cast Iron  | S-type Cast Iron  | S-type Cast Iron  |  |
|                                   |  |  |  |  |  |  |  |  |  |  |  |
|                                   |  | 45°   | 45°   | 45°   | 45°   | 45°   | 0°   | 45°   | 0°  | 0°  |  |
| FRONT CONTROLLED GAS SECURIT HOBS | SECURIT 30 cm DOMINO      | A   | A   | A   | N/A for Wak   | A   | N/A  | N/A   | N/A   | N/A   |  |
|                                   | SECURIT 60/70 cm MODEL 1  | A   | A   | A   | A   | N/A   | N/A  | N/A   | N/A   | N/A   |  |
|                                   | SECURIT 60/70 cm PLUSX    | A   | A   | A   | A   | A   | A  | N/A   | N/A   | N/A   |  |
|                                   | SECURIT 90 cm             | N/A   | N/A   | N/A   | N/A   | N/A   | N/A  | N/A   | N/A   | N/A   |  |

| Knob Limitation Table Built-in Cookers |   |          |   |   |  |
|--|---|----------|---|---|--|
|  |   | BUILT-IN | Side Controlled HOB                             | Front Controlled HOB                            | DOMINO S-I / S-II  |
| ALFA                                   |    | ✓        | ✓   | ✓   | ✓  |
| ANTERO                                 |    | ✓        | Knob with ring Not applicable to Hob range      | Knob with ring Not applicable to Hob range      | Knob with ring Not applicable to Hob range                 |
| BUYUK ANTERO                           |    | ✓        | ✓   | ✓   | ✓  |
| BIG MACRO RING                         |    | ✓        | Knob with ring Not applicable to Hob range      | Knob with ring Not applicable to Hob range      | Knob with ring Not applicable to Hob range                 |
| BIG MACRO                              |    | ✓        | ✓   | ✓   | Not suitable for Domino range. (Alternative - Small Macro) |
| BIG RIMO                               |    | ✓        | ✓   | ✓   | ✓  |
| BIG TRIO                               |   | ✓        | ✓   | ✓   | ✓  |
| DELTA                                  |  | ✓        | ✓   | ✓   | ✓  |
| DELTA RING                             |  | ✓        | Knob with ring Not applicable to Hob range      | Knob with ring Not applicable to Hob range      | Knob with ring Not applicable to Domino range              |
| ECLIPSE                                |  | ✓        | ✓   | ✓   | ✓  |
| ECLIPSE RING                           |  | ✓        | Knob with ring Not applicable to Hob range      | Knob with ring Not applicable to Hob range      | Knob with ring Not applicable to Domino range              |
| EPSILON                                |  | ✓        | Knob with ring It's not applicable to Hob range | Knob with ring It's not applicable to Hob range | Knob with ring Not applicable to Domino range              |
| FEROUS                                 |  | ✓        | No use  | No use  | No use   |
| GAMA                                   |  | ✓        | ✓   | Height of knob is not suitable for FC range     | ✓  |
| GAMA RING                              |  | ✓        | Knob with ring Not applicable to Hob range      | Knob with ring Not applicable to Hob range      | Knob with ring Not applicable to Domino range              |
| JANNU                                  |  | ✓        | ✓   | ✓   | ✓  |
| JANNU RING                             |  | ✓        | Knob with ring Not applicable to Hob range      | Knob with ring Not applicable to Hob range      | Knob with ring Not applicable to Hob range                 |

| Knob Limitation Table Built-in Cookers |  |          |  |  |   |
|--|--|----------|--|--|---|
|  |  | BUILT-IN | Side Controlled HOB                                      | Front Controlled HOB                                     | DOMINO S-I / S-II   |
| NORD                                   |    | ✓        | ✓  | Height of knob is not suitable for FC range              | ✓   |
| NORD RING                              |    | ✓        | Knob with ring Not applicable to Hob range               | Knob with ring Not applicable to Hob range               | Knob with ring Not applicable to Domino range               |
| OMEGA                                  |    | ✓        | Knob with ring Not applicable to Hob range               | Knob with ring Not applicable to Hob range               | Knob with ring Not applicable to Domino range               |
| PIPO                                   |    | ✓        | Pop in-Pop out mechanism is not available for Hob range. | Pop in-Pop out mechanism is not available for Hob range. | Pop in-Pop out mechanism is not available for Domino range. |
| RIMO                                   |    | ✓        | Knob with ring Not applicable to Hob range               | Knob with ring Not applicable to Hob range               | Knob with ring Not applicable to Domino range               |
| RUSTIC RISUS (without ring)            |    | ✓        | ✓  | Height of knob is not suitable for FC range              | ✓   |
| RUSTIC RISUS (with ring)               |   | ✓        | Knob with ring Not applicable to Hob range               | Knob with ring Not applicable to Hob range               | Knob with ring Not applicable to Domino range               |
| SMALL MACRO (with ring)                |  | ✓        | Knob with ring Not applicable to Hob range               | Knob with ring Not applicable to Hob range               | Knob with ring Not applicable to Domino range               |
| SMALL MACRO (without ring)             |  | ✓        | Not suitable for Hob range. (Alternative - Big Macro)    | Not suitable for Hob range. (Alternative - Big Macro)    | ✓   |
| SPECTRUM                               |  | ✓        | Knob with ring Not applicable to Hob range               | Knob with ring Not applicable to Hob range               | Knob with ring Not applicable to Domino range               |
| TRIO                                   |  | ✓        | Knob with ring Not applicable to Hob range               | Knob with ring Not applicable to Hob range               | Knob with ring Not applicable to Domino range               |
| VESTA                                  |  | ✓        | ✓  | Height of knob is not suitable for FC range              | ✓   |
| VARIO                                  |  | ✓        | ✓  | ✓  | ✓   |
| VARIO RING                             |  | ✓        | Knob with ring Not applicable to Hob range               | Knob with ring Not applicable to Hob range               | Knob with ring Not applicable to Domino range               |
| ZENITH                                 |  | ✓        | No use   | No use   | No use  |
| ZETA                                   |  | ✓        | ✓  | ✓  | ✓   |
| ZETA RING                              |  | ✓        | No use   | No use   | No use  |

INSTALLATION OF BUILT-IN OVEN

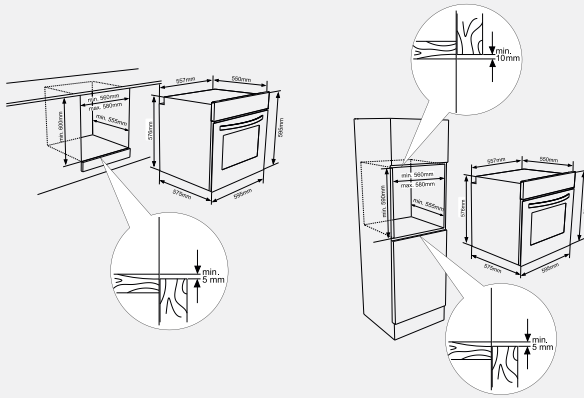

INSTALLATION OF COMBI VITROCERAMIC HOB AND BUILT-IN OVEN

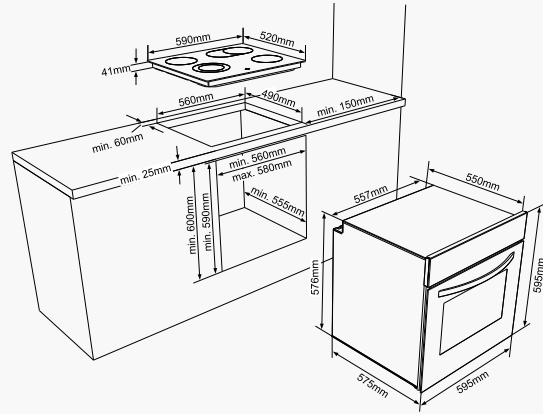

INSTALLATION OF COMBI ELECTRIC HOB AND BUILT-IN OVEN

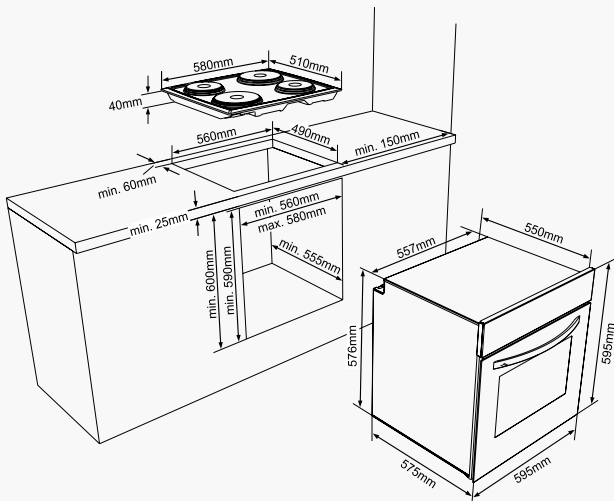

INSTALLATION OF COMBI INDUCTION HOB AND BUILT-IN OVEN

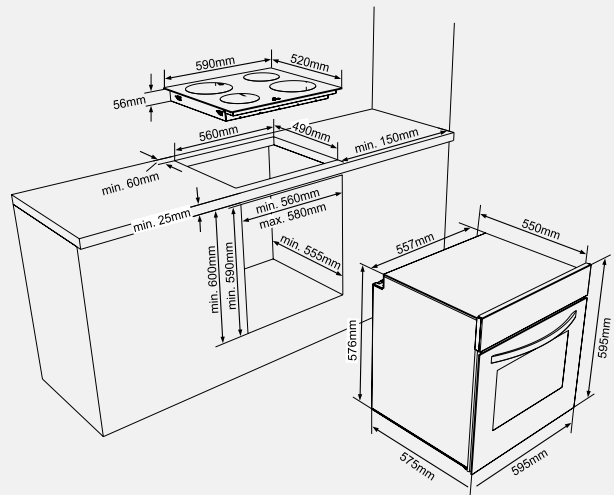

INSTALLATION OF NEW GENERATION 90CM INDUCTION HOB

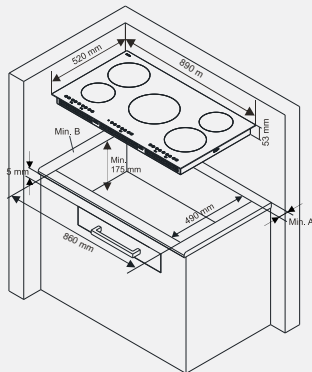

| Neighbourhood walls       | A [mm] | B [mm] |
|---------------------------|--------|--------|
| Wood                      | 60     | 150    |
| Concrete or ceramic tiled | 25     | 40     |

\* In the case of installation over built-in oven, distance should be min. 10 mm.

90CM GAS ON GLASS HOB WITH FRONT CONTROL INSTALLATION

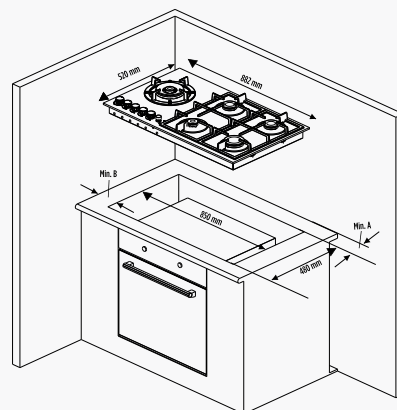

| Neighbourhood walls: | Min. A | Min. B |
|----------------------|--------|--------|
| Combustible:         | 80 mm  | 180 mm |
| Non-combustible:     | 60 mm  | 80 mm  |

INSTALLATION OF NEW GENERATION 78CM INDUCTION HOB

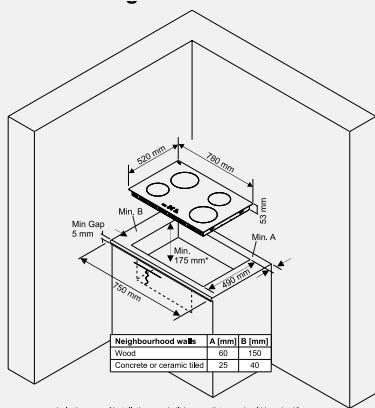

\* - In the case of installation over built in oven distance should be min. 10 mm.

INSTALLATION OF 78CM INDUCTION HOB

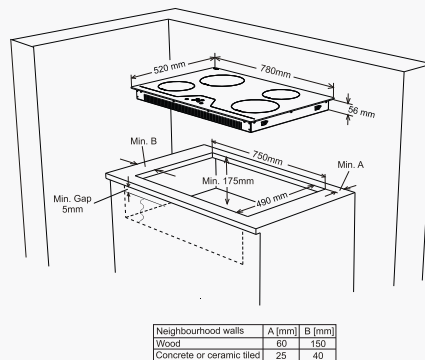

INSTALLATION OF 78CM VITROCERAMIC HOB WITH FRONT TOUCH CONTROL

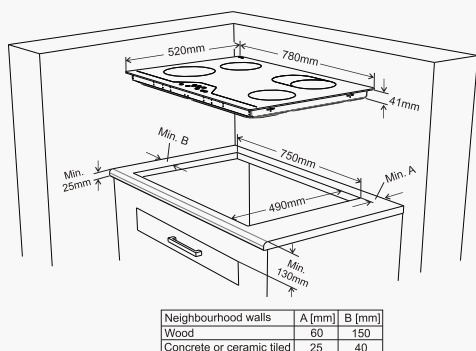

70CM GAS HOB WITH FRONT CONTROLLED PLUSX DESIGN

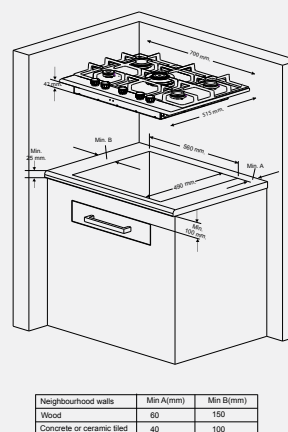

INSTALLATION OF 70CM GAS ON GLASS HOB WITH FRONT CONTROLLED PLUSX DESIGN

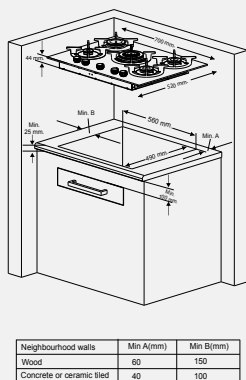

INSTALLATION OF 70CM GAS ON GLASS HOB WITH FRONT CONTROL

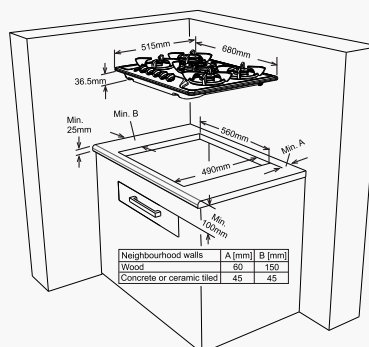

INSTALLATION OF 70CM GAS HOB WITH FRONT CONTROL

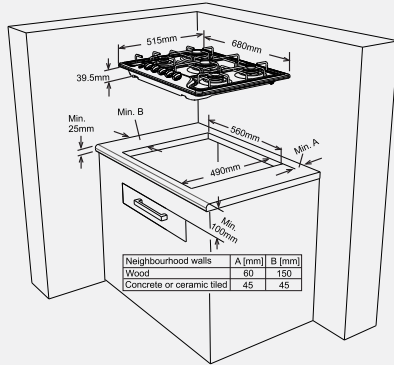

INSTALLATION OF NEW GENERATION 60CM INDUCTION HOB

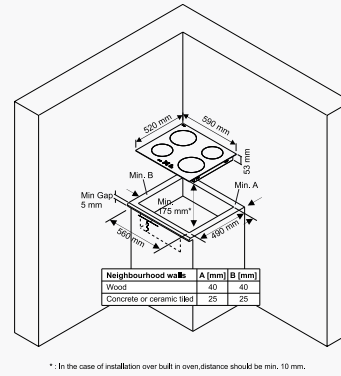

INSTALLATION OF 60CM INDUCTION HOB

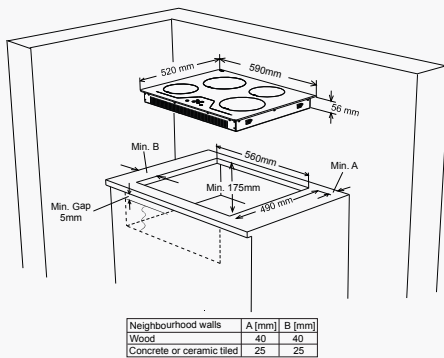

INSTALLATION OF 60CM VITROCERAMIC HOB WITH TRIANGULAR TOUCH CONTROL

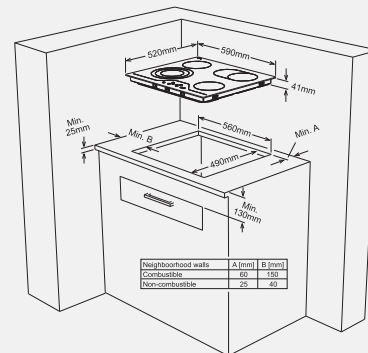

INSTALLATION OF 60CM VITROCERAMIC HOB WITH SIDE KNOB CONTROL

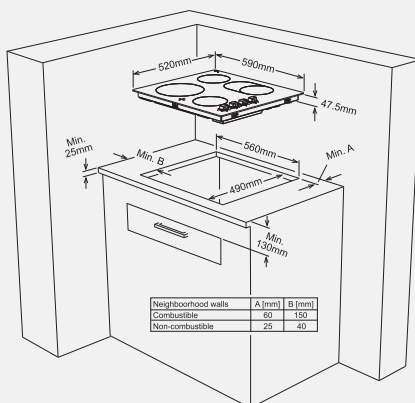

INSTALLATION OF 60CM VITROCERAMIC HOB WITH FRONT TRIANGULAR TOUCH CONTROL (1X180, 1X45, 1X270, TRIPLE ZONE)

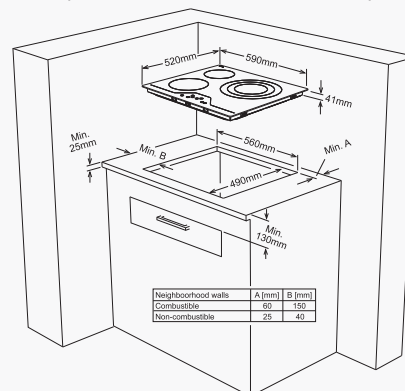

60CM GAS & VITROCERAMIC ON GLASS HOB WITH SIDE CONTROL PURE DESIGN

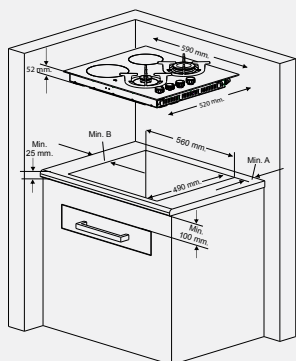

| Neighbourhood walls       | Min A(mm) | Min B(mm) |
|---------------------------|-----------|-----------|
| Wood                      | 60        | 150       |
| Concrete or ceramic tiled | 40        | 50        |

60CM GAS & INDUCTION ON GLASS HOB WITH SIDE CONTROL PURE DESIGN

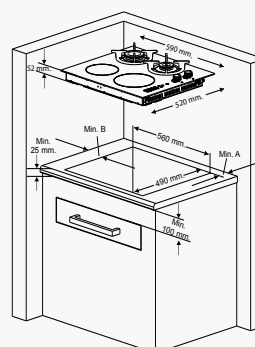

| Neighbourhood walls       | Min A(mm) | Min B(mm) |
|---------------------------|-----------|-----------|
| Wood                      | 60        | 150       |
| Concrete or ceramic tiled | 40        | 50        |

60CM GAS ON GLASS HOB WITH FRONT CONTROLLED PLUSX DESIGN

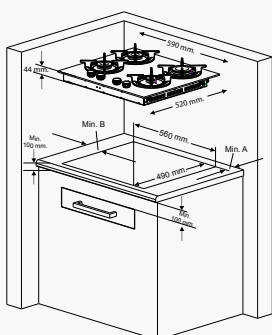

| Neighbourhood walls       | Min A(mm) | Min B(mm) |
|---------------------------|-----------|-----------|
| Wood                      | 60        | 150       |
| Concrete or ceramic tiled | 40        | 50        |

INSTALLATION OF 60CM GAS HOB WITH FRONT CONTROLLED PLUSX DESIGN

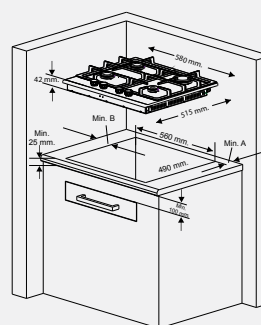

| Neighbourhood walls       | Min A(mm) | Min B(mm) |
|---------------------------|-----------|-----------|
| Wood                      | 60        | 150       |
| Concrete or ceramic tiled | 40        | 50        |

INSTALLATION OF 60CM GAS ON GLASS HOB WITH SIDE CONTROL SERIE 2

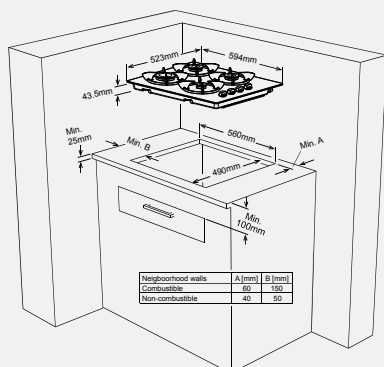

| Neighbourhood walls | A (mm) | B (mm) |
|---------------------|--------|--------|
| Combustible         | 60     | 150    |
| Non-combustible     | 40     | 50     |

INSTALLATION OF 60CM GAS ON GLASS HOB WITH SIDE CONTROL

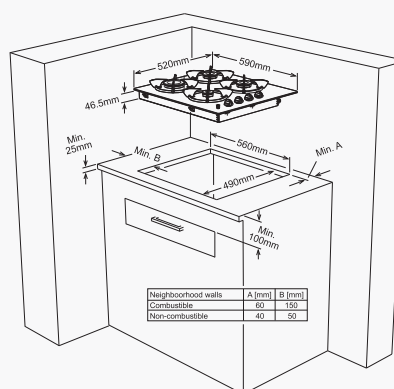

| Neighbourhood walls | A (mm) | B (mm) |
|---------------------|--------|--------|
| Combustible         | 60     | 150    |
| Non-combustible     | 40     | 50     |



INSTALLATION OF 60CM GAS ON GLASS HOB WITH FRONT CONTROL

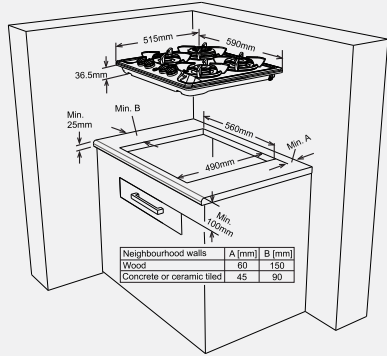

INSTALLATION OF 60CM GAS HOB WITH SIDE CONTROL

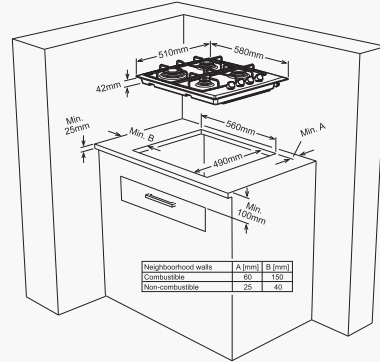

INSTALLATION OF 60CM GAS HOB WITH FRONT CONTROL

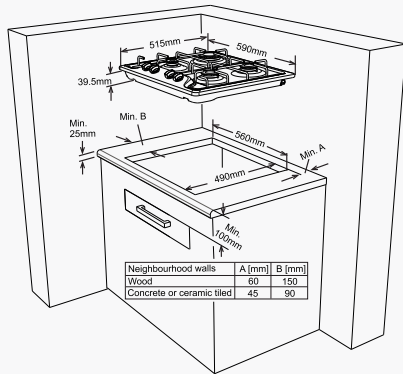

INSTALLATION OF 60CM ELECTRIC HOB WITH SIDE CONTROL

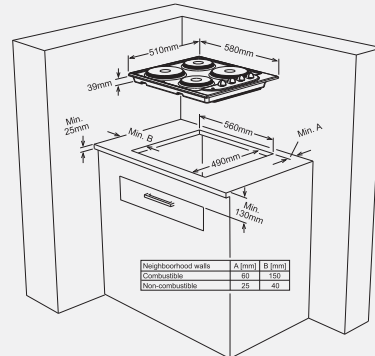

INSTALLATION OF NEW GENERATION 30CM INDUCTION DOMINO HOB WITH TOUCH CONTROL

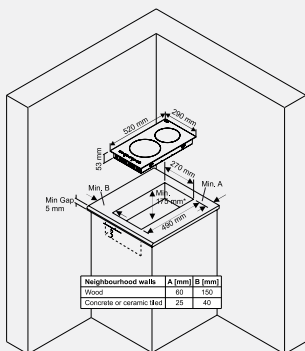

\* In the case of installation over built-in oven distance should be min. 10 mm.

INSTALLATION OF 30CM INDUCTION DOMINO HOB WITH TOUCH CONTROL

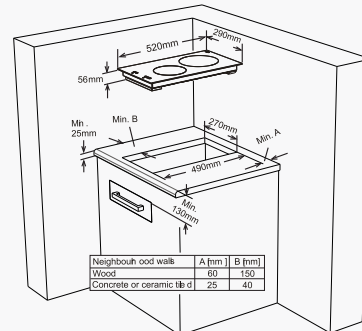

INSTALLATION OF 30CM VITROCERAMIC DOMINO HOB WITH TOUCH CONTROL

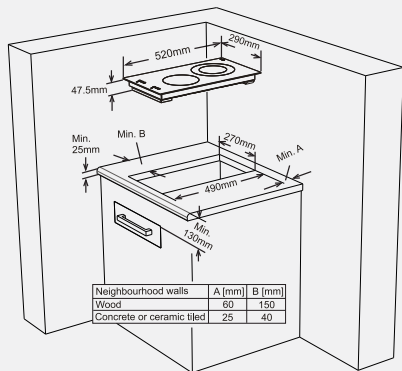

INSTALLATION OF 30CM VITROCERAMIC DOMINO HOB WITH KNOB CONTROL

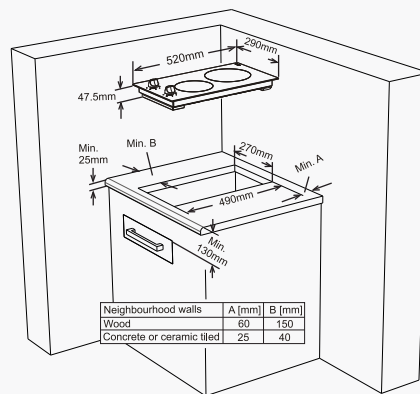

INSTALLATION OF 30CM GAS ON GLASS DOMINO HOB

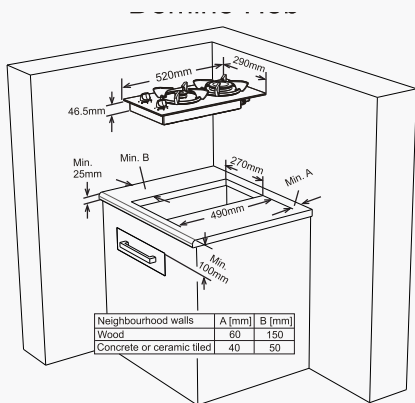

INSTALLATION OF 30CM DOMINO GAS HOB WITH FRONT CONTROL (SERIE2)

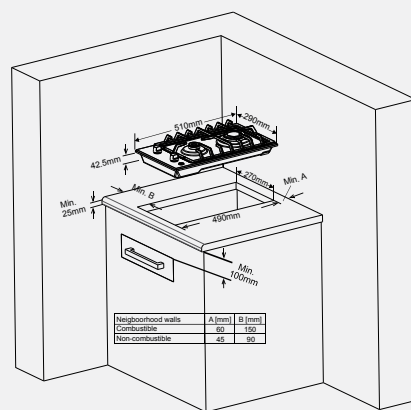

INSTALLATION OF 30CM ELECTRIC HOB WITH FRONT CONTROL

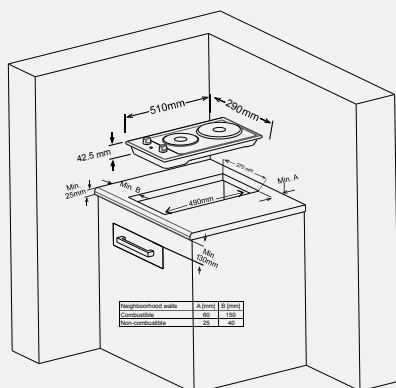



**Vestel Trade Co.**

Organize Sanayi Bölgesi, 45030 Manisa/Türkiye

**Phone:** 90 - 236 233 25 82

**Fax:** 90 - 236 233 25 84

vesteltrade@vestel.com.tr

www.vestel.com.tr

**Vestel Benelux B.V.**

P.O. Box 29179 3001 GD - Rotterdam / Netherlands

**Phone:** 31 - 10 235 1000

**Fax:** 31 - 10 235 1003

info@vestelbenelux.nl

www.vestelbenelux.nl

**TOO Vestel Central Asia**

Dostyk Avenue, 132 , Office 6, Almaty/Kazakhstan

**Phone:** 7 - 727 262 83 01

**Vestel CIS Ltd.**

1-st Graivoronovsky Proezd, No.20 Building 16, 109518,

Moscow /Russia

**Phone:** 7 - 095 956 8230

**Fax:** 7 - 095 956 8233

info@vestel.ru

www.vestel.ru

**Vestel Electronica**

Str Zidarului nr 9-11, Sector 5 Bucuresti, ZIP 051765

Bucharest/Romania

**Phone:** 40 - 31 425 42 93

**Fax:** 40 -31 425 42 95

office@vestel.ro

www.vestel.ro

**Vestel France S.A.**

17 Rue de la Couture-Silic BP 10190-94563 RUNGIS

Cedex/France

**Phone:** 33 - 1 46 75 00 29

**Fax:** 33 - 1 41 80 99 31

p.benhamou@vestel-france.fr

**Vestel Germany GmbH**

Parkring 6 85748 Garching b. München/Germany

**Phone:** 49 - 89 55295 - 0

**Fax:** 49 - 89 55295 - 2000

info@vestel-germany.de

www.vestel-germany.de

**Gruppo Industriale Vesit SPA**

Via polidoro da Caravaggio, 6, 20156 - Milano/Italy

**Phone:** 39 - 02 842 48577

**Fax:** 39 - 02 842 48617

info@givesit.it

www.givesit.it

**Vestfrost Household**

Spangsbjerg Mollevej 100, DK-6705 Esbjerg 0, Denmark

**Phone:** 45 - 7610 4045

**Fax:** 45 - 7610 4046

**Vestel Iberia**

Avda, Partenon, 16-18 Planta 1 Oficina 6, 28042 Madrid/

Spain

**Phone:** 34 -91 320 63 98

**Fax:** 34 -91 320 52 58

vestel@vestel.es www.vestel.es

**Vestel Poland**

Poleczki 33, 02-822 Warszawa, Mazowieckie

**Phone:** 48 22 2555700

info@vestel-poland.com

**Vestel Scandinavia**

Postikatu 4, FI-04400 Järvenpää / Finland

**Phone:** 358 - 46 712 2262

**Fax:** 358 - (0) 9 251 7 8222

**Vestel UK Ltd**

Vestel House, Waterside Drive

Langley, Berkshire SL3 6EZ

**Phone:** 44 - 3330 146 400

info@vestel-uk.com

www.vestel.co.uk

**United Technical Services**

S.R.O. ul. Seneckâ 16, 91101 Samorin, Slovakia

**Phone:** 421- 31 590 27 31

**Fax:** 421- 31 590 27 38

info@uts.sk

www.uts.sk

# VESTEL

---

Organize Sanayi Bölgesi, 45030 Manisa/Türkiye  
**Phone:** 90 - 236 233 25 82 **Fax:** 90 - 236 233 25 84  
vesteltrade@vestel.com.tr  
www.vestel.com.tr